

INOVA

PLUG AND PLAY

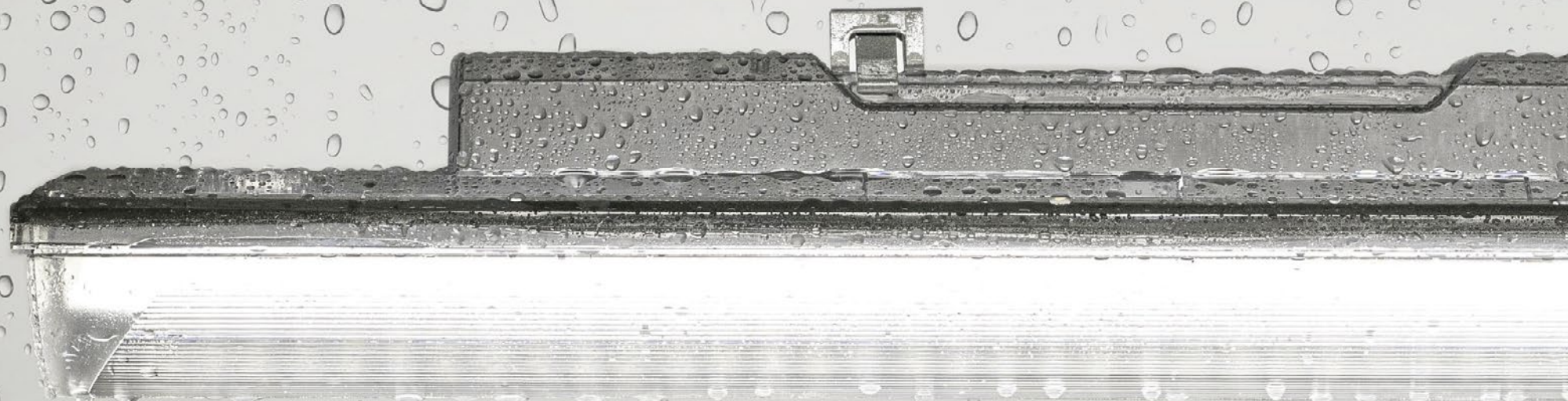

PolestarLED
by Nordic Eco Energy

Do you want to change your traditional lighting into LEDs?

INNOVA, IP66-moisture-proof luminaire, is a simple, low-cost and extremely fast solution for relamping and lighting redesign.

Innova is ready-made luminaire with smart connectors and flexible ceiling brackets.

The electrical connection is made from outside and the installation is done either on the ceiling via a trunking (cable tray) system.

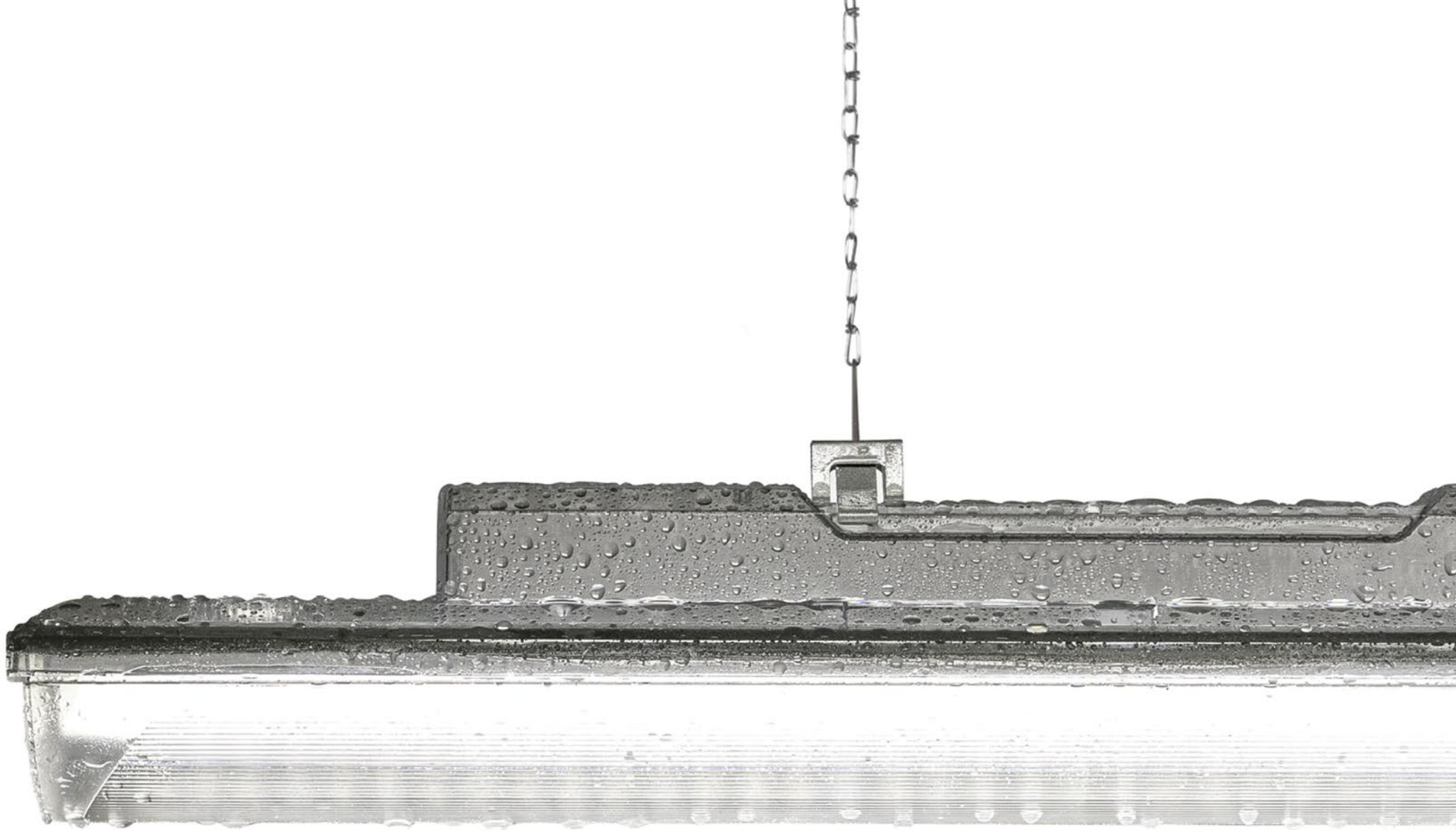

WHY?

SMART CONNECTORS

Easy connection in less than **6 MINUTES**
No need to open the entire luminaire
just **PLUG and PLAY.**

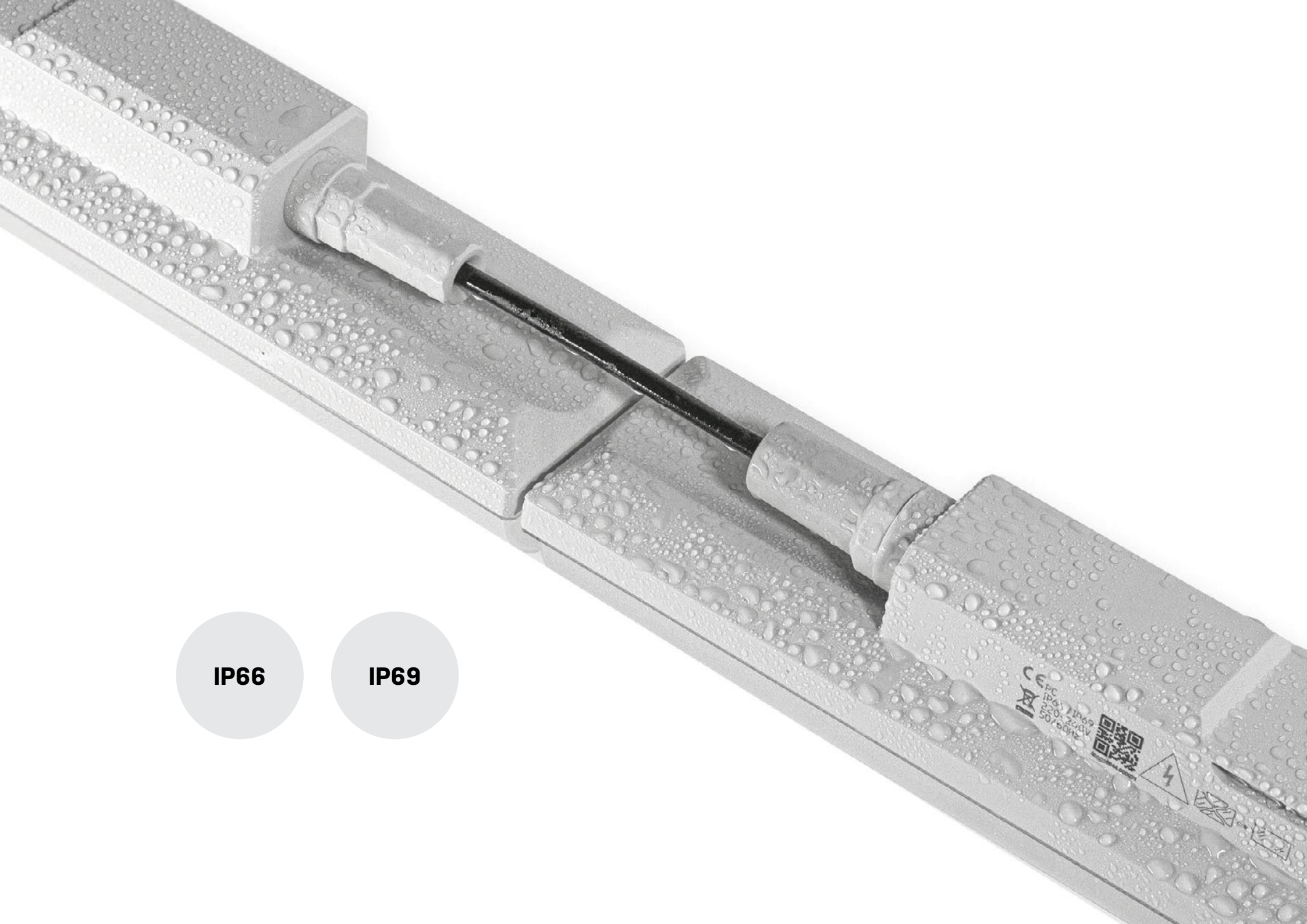

IP66

IP69

CE
IP69
200-200V
50/60Hz
QR CODE



WHY?

MULTIFUNCTIONAL BRACKET

With its newly redesigned bracket it is perfect for **CONTINUOUS ROW** lighting system - TRUNKING (CABLE TRAY) system.

Fits to general continuous row solution of 60 mm width.

Perfect for **LINE MOUNTING**.

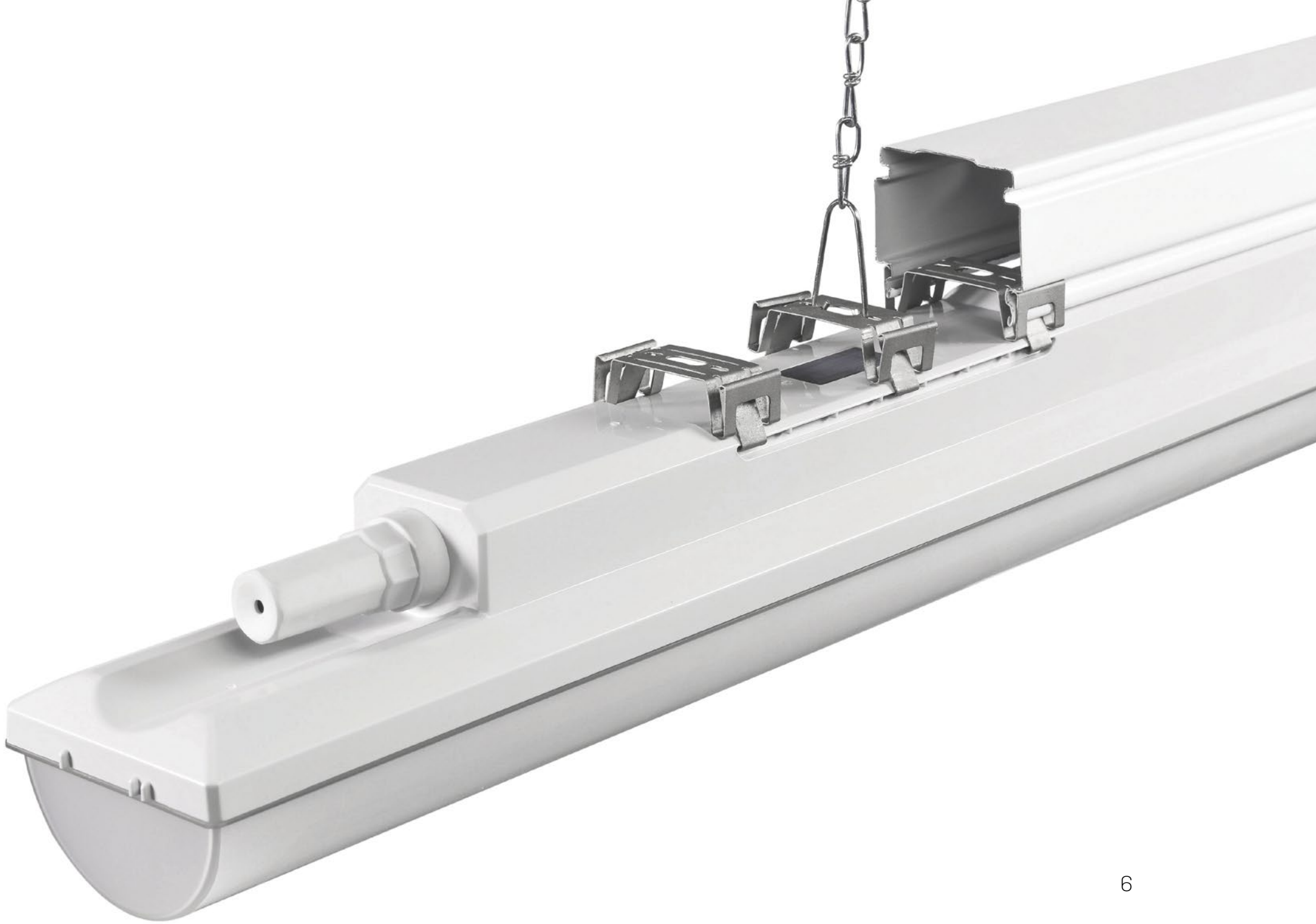

**INDUSTRIAL BUILDINGS,
FAIR TRADE HALLS,
GARAGES,
WAREHOUSES AND
TUNNELS**



**CAR PARK APPLICATIONS,
TRANSPORT TERMINALS AND
OUTDOOR SPACES
(EVEN WITHOUT SHELTER)**



FOODSTUFF PRODUCTION AND FOOD STORAGE

Foodstuff industry is characterized by extreme temperature conditions and high levels of humidity.

INNOVA complies with HACCP regulations to fulfill stringent hygienic and safety technical standards for the food industry.

INNOVA with IK10 and unopenable housing prevents dust and moisture penetration and can be completely cleaned with pressure washers (IP 69).



FARMS AND AGRICULTURAL FACILITIES

Innova ABS is ammonia resistant.

It has been approved by the German Agricultural Society.

INNOVA with IK10 and unopenable housing prevents dust and moisture penetration and can be completely cleaned with pressure washers (IP 69).

Optional version with red LED chips for cowhouses - red night lights don't disturb the sleep cycles of cows and can be used to facilitate cow movement and observation during darkness.
Optional version with blue LED chips for poultry farms - blue light has a calming effect and significantly reduces aggressive behaviour in poultry.



BENEFITS:

Fast and simple connection in 6 minutes with simple tools
Installation under the supervision of just one electrician and a team of unskilled workers.

No damage on the internal electronics during installation.
Extremely reliable unopenable luminaire – even in extreme conditions.

Economically very attractive luminaire.
Low cost and money saving solution.

Smart for RELAMPING and LIGHTING REDESIGN
Product of professionals with 30 years experience in weatherproof industrial lighting.



SIMPLE
INSTALLATION



100% QUALITY
CONTROL



IP 66
IP 69

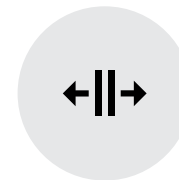

VARIABLE
MOUNTING PITCH



THE COST OF THE INSTALLATION OF 120 LUMINAIRES PCS

PARAMETERS	STANDARD CONNECTION	INNOVA	ADVANTAGES AND BENEFITS
ASSEMBLE TO:	Terminal block	Connector	VERY EASY ASSEMBLY
WHO CONNECTS THE LIGHTS?	Electrician	Assembler	NO NEED FOR QUALIFICATIONS
WHAT IS THE FEE?	25 – 55 € per hour	17 – 30 € per hour	8 – 25 € SAVED
TIME EXPENDITURE	60 hours	30 hours	50 % TIME SAVED
COST OF ASSEMBLY	1500 – 3300 €	510 – 900 €	990 – 2400 € SAVED 66 – 72,8 % COST SAVED



TECHNICAL FEATURES:

High quality and controlled production process
Strong performance up to 150 lm/W
Service life 50 000 hours (L90)
EU sourced high quality plastic materials with a guarantee of UV stabilization
Non-dismountable housing for minimalization of risks of dust and moisture penetration
LED diode protection against damage during installation
Very high protection of IP66 and IP69
Impact resistance of IK10
High performance - temperature resistance up to 50°C
Built-in ventilation membrane for minimalization of internal condensation
HACCP and DLG conformity





ONE MATERIAL:

One material - one housing for full resistance during any physical expansion caused by changes in temperature

ABS / ABS - PC / PC - TRS PC / PC

BODY:

ABS for chemically aggressive environments with ammonia, fats, oils, acids and alkalis

PC for general usage and impact resistance.
Transparent (TRS) PC for low ceilings in indoor parking areas

DIFFUSER:

Variation of diffuser's technology:
TRANSLUCENT PC or ABS
TRANSPARENT PC or ABS with Fresnel lenses for special wide or narrow beam applications



ONE MATERIAL

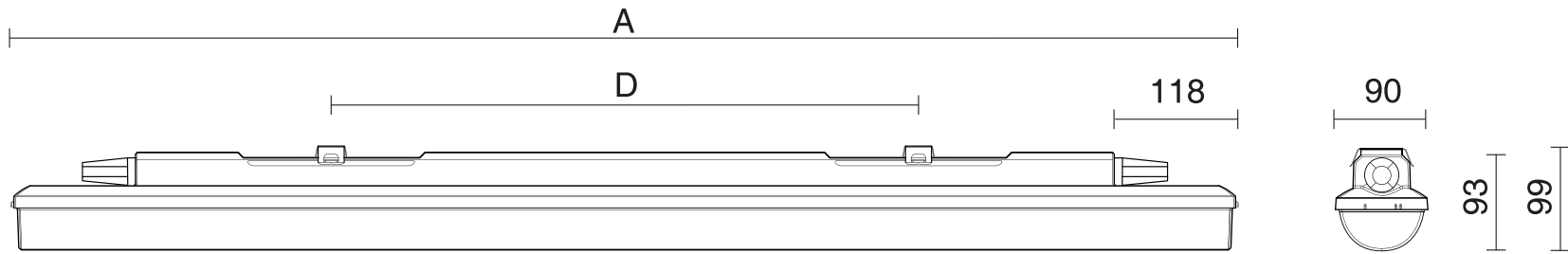

INNOVA ABS

	Ambient temperature [°C]	Luminous flux of LED modules [lm]	Luminous flux of tight fitting [lm]	Power consumption [W]	System efficacy [lm/W]	Net weight [kg]	A [mm]	D [mm]
INNOVA 1.4ft ABS 2600/840	50	2580	2400	16	150	1,5	1175	420 - 700
INNOVA 1.4ft ABS 3200/840	50	3110	2890	20	145	1,5	1175	420 - 700
INNOVA 1.4ft ABS 4400/840	45	4350	4050	27	150	1,5	1175	420 - 700
INNOVA 1.4ft ABS 6400/840	45	6260	5820	38	153	1,5	1175	420 - 700
INNOVA 1.4ft ABS 8800/840	40	8710	8100	51	159	1,6	1175	420 - 700
INNOVA 1.5ft ABS 3250/840	50	3240	3010	20	151	1,8	1455	700 - 980
INNOVA 1.5ft ABS 4000/840	50	3880	3610	24	150	1,8	1455	700 - 980
INNOVA 1.5ft ABS 5500/840	45	5420	5040	33	153	1,8	1455	700 - 980
INNOVA 1.5ft ABS 8000/840	45	7740	7200	45	160	1,8	1455	700 - 980
INNOVA 1.5ft ABS 11000/840	40	12050	11210	71	158	1,9	1455	700 - 980

INNOVA NB ABS

INNOVA 1.4ft NB ABS 4400/840	45	4350	3830	27	142	1,5	1175	420 - 700
INNOVA 1.4ft NB ABS 6400/840	45	6260	5510	38	145	1,5	1175	420 - 700
INNOVA 1.5ft NB ABS 5500/840	45	5420	4770	33	145	1,8	1455	700 - 980
INNOVA 1.5ft NB ABS 8000/840	45	7740	6810	45	151	1,8	1455	700 - 980

INNOVA WB ABS

INNOVA 1.4ft WB ABS 2600/840	50	2580	2270	16	142	1,5	1175	420 - 700
INNOVA 1.4ft WB ABS 3200/840	50	3110	2740	20	137	1,5	1175	420 - 700
INNOVA 1.4ft WB ABS 4400/840	45	4350	3830	27	142	1,5	1175	420 - 700
INNOVA 1.4ft WB ABS 6400/840	45	6260	5510	38	145	1,5	1175	420 - 700
INNOVA 1.5ft WB ABS 3250/840	50	3240	2850	20	143	1,8	1455	700 - 980
INNOVA 1.5ft WB ABS 4000/840	50	3880	3410	24	142	1,8	1455	700 - 980
INNOVA 1.5ft WB ABS 5500/840	45	5420	4770	33	145	1,8	1455	700 - 980
INNOVA 1.5ft WB ABS 8000/840	45	7740	6810	45	151	1,8	1455	700 - 980

INNOVA

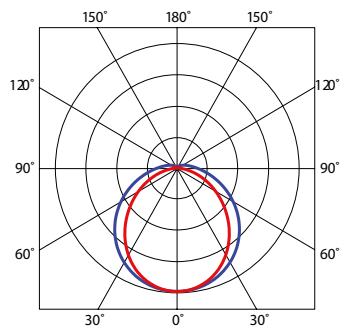
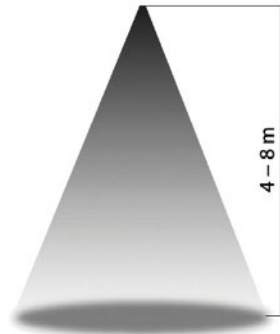

INNOVA NB

Narrow beam

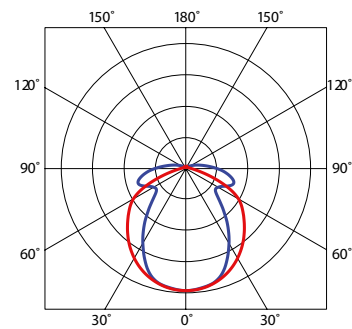

INNOVA WB

Wide beam

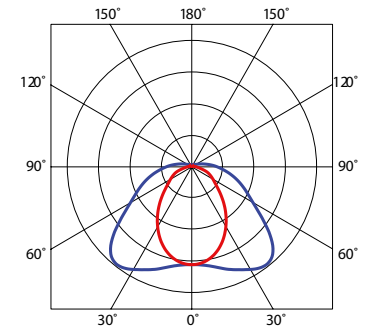
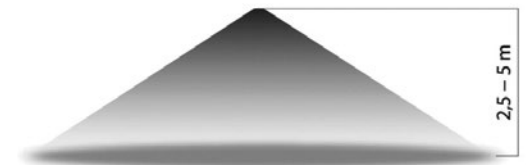





 **Nordic** Svensk
EcoEnergy Återförsäljare
Nordic Eco Energy AB
Tel. 070-644 28 16 - info@nordicecoenergy.se - www.nordicecoenergy.se

Phone: +46 70 6442816

Email: info@nordicecoenergy.se



TREEVOS