

# I-MAGO



Con il suo disegno unico e sapiente nelle proporzioni I-MAGO esalta la leggerezza e lo slancio delle forme accendendosi come una piccola cascata, una clessidra luminosa. L'esile stelo che si illumina in realtà supporta una scheda LED superiore capace di illuminare cospicuamente a terra in modo diretto, verso il basso, con un'apertura di diffusione di 120° e senza dispersione verso l'alto. Per inserirsi con discrezione ed eleganza nei giardini, presso i camminamenti, ai bordi degli spazi aperti, si compone con i pali in due diverse altezze in alluminio estruso o acciaio inossidabile.

With its unique design and skilful proportions, I-MAGO enhances the lightness and momentum of the shapes, lighting up like a small waterfall, a luminous hourglass. The slender stem that actually lights up supports an upper LED board capable of brightly illuminating the ground directly, downwards, with a diffusion angle of 120° and without upward dispersion. To fit with discretion and elegance in the gardens, near the walkways, at the edges of open spaces, it is composed with poles in two different heights in extruded aluminum or stainless steel.

## POLES



I-MAGO

# I-MAGO



## Struttura

Coppa in policarbonato trasparente stabilizzato anti UV. Parti interne in alluminio satinato. Corpo completo di scatola di cablaggio in tecnopolimero autoestinguente con anello di raccordo in alluminio verniciato o cromato.

## Structure

Transparent polycarbonate UV resistant stabilised diffuser. Internal parts in satin aluminium. Body complete with self-extinguishing technopolymer wiring box with painted aluminium or chrome connection ring.

Il corpo lampada è dotato di 2 pressacavi per consentire l'alimentazione passante.

The lamp body is provided with 2 cable glands for through wiring.

## Pali

- lisci, in **alluminio estruso**, completi di base in alluminio forgiato. Disponibili in due differenti altezze. La finitura antracite anti-UV garantisce la completa tenuta nel tempo
- in **acciaio inox AISI 316L**, spazzolati e lucidati, destinati a resistere nel tempo anche negli ambienti maggiormente esposti a corrosione. La sezione poligonale è un personale design ottenuto da trafilatura

## Poles

- smooth, in **extruded aluminium** and base in forged aluminium. Available in two different heights. The finish anthracite makes I-LUX not invasive and ideal to be installed everywhere in the garden
- in **AISI 316L stainless steel**, brushed and polished, made to resist to the most corrosive environments. The original polygonal profile enhances the pole

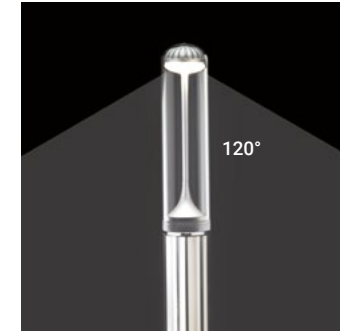
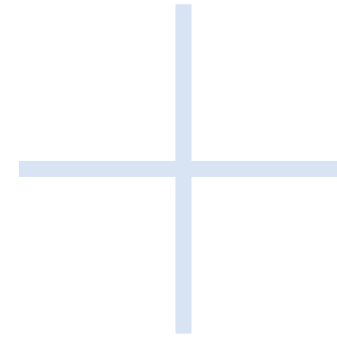

## Piccola cascata di luce

La luce è orientata verso il basso con un angolo di diffusione di 120°.

## Small waterfall of light

The light is directed downwards with an angle of diffusion of 120°.

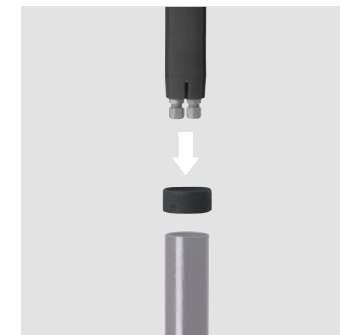

## Adattatore per pali Ø 60 mm

Gli apparecchi I-MAGO possono essere installati mediante uno speciale raccordo anche su qualsiasi palo di mercato di Ø 60 mm.

## Adaptor for Ø 60 mm poles

I-MAGO can be installed on any type of Ø 60 mm pole available on the market by a very simple adaptor.





# I-MAGO

Pali da giardino / Garden poles



## CORPI LAMPADA / LIGHT BODIES



aluminium



AISI 316L st. steel

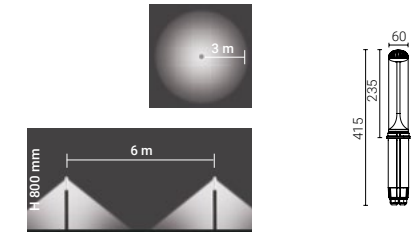

	Code	
5510	● AN - anthracite	3K - 3000K
5500	● IN - stainless steel	4K - 4000K

Material	Lamp	W	Lm LED	Real Lm	Optic
aluminium	LED	7,5	750	380	diffuse
AISI 316L st. steel					

Su richiesta / On request  
10÷52V low voltage (code + LV)

## PALI / POLES



codes 3421 3422 AN



codes 3511 3512 IN

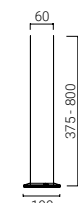

codes 3421 3422



codes 3511 3512

	Code	
3421	● AN - anthracite	
3422		
3511	● IN - stainless steel	
3512		

H	Description
375 mm	Palo liscio in alluminio estruso, comprensivo di base esterna in alluminio forgiato / Smooth pole in extruded aluminium with integrated external ground fixing base in forged aluminium
800 mm	
375 mm	Palo e base in acciaio inox AISI 316L, interamente spazzolato e lucidato / Pole and base in AISI 316L stainless steel, brushed and polished
800 mm	



# I-MAGO

Accessori / Accessories



## PICCHETTO / SPIKE

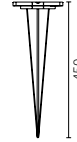

Code	Description
5505	Picchetto da giardino in tecnopolimero, listelli laterali di bloccaggio incorporati / Garden spike in technopolymer, side blocking bars incorporated

## PIASTRA TIRAFONDI / PLATE WITH ANCHORING SET

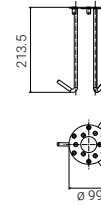

Code	Description
5519	Piastra inox con tirafondi per ancoraggio al terreno / Stainless steel plate with ground anchoring set

## RACCORDO PER PALI STANDARD / ADAPTOR FOR STANDARD POLES Ø 60 mm

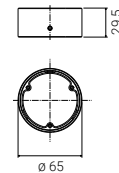

Code	Description
5506	Raccordo in alluminio primario pressofuso, adattabile a qualsiasi palo Ø 60 mm / Adaptor in die-cast primary aluminium, to be installed on any pole Ø 60 mm



 **Nordic** Svensk  
**EcoEnergy** Återförsäljare  
Nordic Eco Energy AB  
Tel. 070-644 28 16 - info@nordicecoenergy.se - www.nordicecoenergy.se