



light



# DISEGNO DELLA LUCE

DESIGN OF THE LIGHT

Quando il progetto di design prende il via dall'intuizione, l'ingegnerizzazione segue il processo fino a definire l'estetica e la realizzazione - la forma segue la funzione, ma entrambe seguono la luce. E la luce è allo stesso tempo il fine ultimo e la spinta di ricerca originaria.

When the design project starts from intuition, the engineering follows the process until it defines the aesthetics and the realization - the form follows the function, but both follow the light. And light is at the same time the ultimate goal and the original drive of the research.



# LUCE NELLA FORMA

LIGHT INTO THE FORM

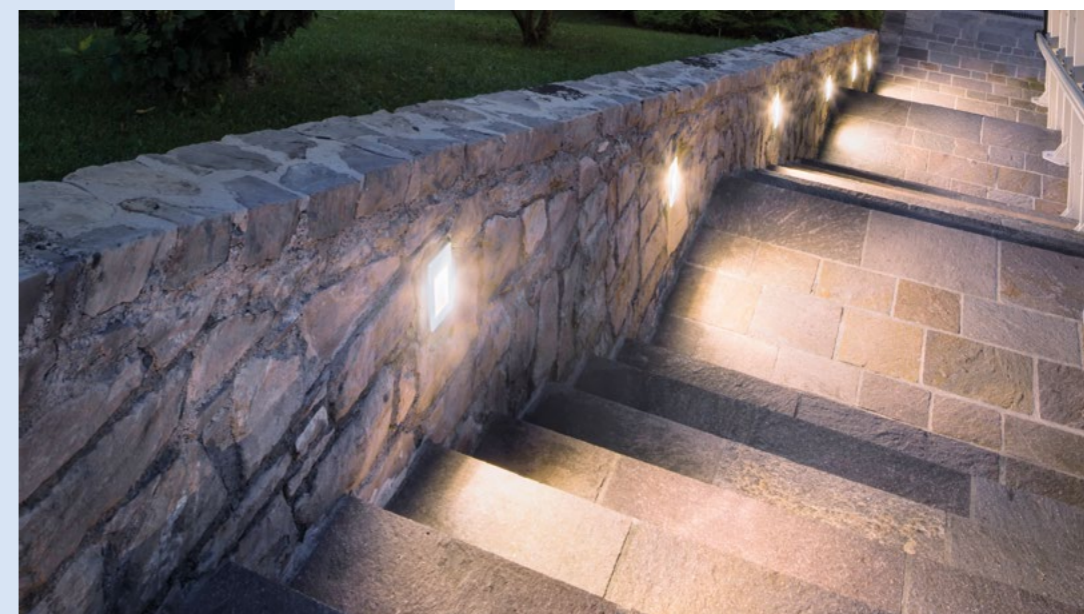
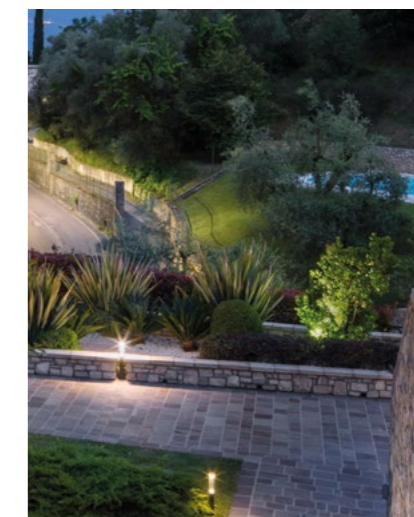

4	<b>PROFILO AZIENDALE</b> COMPANY PROFILE
15	<b>INDICE PER SERIE</b> INDEX BY SERIES
16	<b>INDICE PER APPLICAZIONE</b> INDEX BY APPLICATION
22	<b>PRODOTTI</b> PRODUCTS
310	<b>INFORMAZIONI GENERALI</b> GENERAL INFORMATION
314	<b>INDICE PER CODICE</b> INDEX BY CODE

**goccia**  
ILLUMINAZIONE

Il principio di Goccia Illuminazione è da sempre dare alla luce alloggio, protezione e libertà di espressione - questa la funzione. Trasformare un concetto in un prodotto finito risulta ogni volta una sfida entusiasmante, ricca di scelte ed impegno, sostenibile nel segno del made in Italy, per arrivare ad illuminare l'architettura, i giardini e gli spazi esterni, per portare luce alle persone che li vivono. Con questo spirito e sempre rinnovato entusiasmo, Goccia Illuminazione porta luce nella forma.

The principle of Goccia Illuminazione has always been to give a space to the light, protection and freedom of expression - this is the function. Transforming a concept into a finished product is every time an exciting challenge, full of choices and commitment, sustainable in the sign of the made in Italy, to finally illuminate architecture, gardens and outdoor spaces, to bring light to the people who live them. With this spirit and with always renewed enthusiasm, Goccia Illuminazione brings light into the form.

# GOCCIA ILLUMINAZIONE



Da oltre 40 anni Goccia Illuminazione realizza prodotti unici per l'illuminazione da esterno per l'Italia e per il mondo. La costante crescita concentrata sullo sviluppo di questo settore ha portato l'originariamente piccola attività industriale di Poncarale, a sud di Brescia, ad espandersi dal 1977 fino ad oggi su cinque aree produttive adiacenti, dislocate su di una superficie di capannoni e uffici di oltre 8.000 metri quadrati. La goccia, simbolo internazionale ed intuitivo della tenuta stagna nella normativa per apparecchi illuminanti all'epoca della fondazione, diede il nome e la traccia che ancora oggi seguiamo in costante evoluzione tecnica per soddisfare le esigenze dei nostri clienti e proporre nuovi percorsi nella luce.

For over 40 years Goccia Illuminazione has been producing unique products for outdoor lighting for Italy and the world. The constant growth concentrated on the development in this sector has led the originally small industrial activity in Poncarale, south of Brescia, to expand from 1977 until today on five adjacent production areas, spread over an area of warehouses and offices of over 8.000 square meters. The drop (goccia in Italian), an international and intuitive symbol of watertightness in the legislation for lighting fixtures at the time of its foundation, gave the name and the trace that we still follow in constant technical evolution to meet the needs of our customers and propose new paths in the light.



## IDEA

Immaginare. Innovare. Ispirare. E poi cominciare di nuovo.  
Imagine. Innovate. Inspire. And then start all over again.



## PROJECT

Il processo di progettazione, verifica e studio dei materiali.  
Process of designing, testing and studying materials.

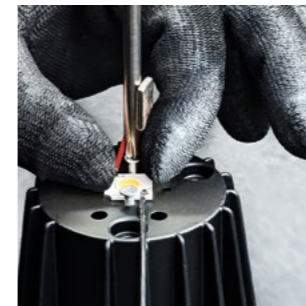

## PRODUCTION

Il cuore pulsante dell'azienda nel contesto della rete industriale locale.  
The beating heart of the company in the local industrial network.



## CONSULTANCY

Supporto tecnico e calcolo illuminotecnico per tutta la fase progettuale.  
Technical support and lighting calculation along the whole project phase.



## NETWORK

Rete di rivenditori ed installatori in Italia e nel mondo. Con 5 anni di garanzia e assistenza.  
Support of dealers and installers network with 5-year warranty and assistance.



# DA OLTRE 40 ANNI PRODOTTI UNICI PER L'ILLUMINAZIONE DA ESTERNI

FOR OVER 40 YEARS  
UNIQUE PRODUCTS  
FOR OUTDOOR LIGHTING

goccia  
ILLUMINAZIONE

1977

La serie **GOCCIA** apre la strada nell'illuminazione per esterno come plafoniera colorata e versatile.

The **GOCCIA** series leads the way in outdoor lighting as a colorful and versatile lamp.



1980

**TRIANGOLO** porta le innovative forme triangolari, il design caratteristico negli anni a venire.

**TRIANGOLO** brings the innovative triangular shape, distinctive design for years to come.



1990

**KASKO** e l'alluminio segnano il salto di qualità per tenuta, robustezza e finitura. E allo stesso tempo l'inventiva esplora nuovi scenari, come per **SUMMERTIME**.

**KASKO** and aluminum mark the breakthrough in terms of watertight, strength and finish. And at the same time creativity explores new scenarios, as for **SUMMERTIME**.



2000

Prosegue l'evoluzione tecnica e dell'illuminazione architettonica con **SMALL MIDI MAXI & SUPERMAXI** e **STRIKE**, nella prima versione LED.

The technical and architectural lighting evolution carries on with **SMALL MIDI MAXI & SUPERMAXI** and **STRIKE**, in the first LED version.



2010

La tecnologia LED più avanzata si combina col concetto di modularità: arrivano **QUANTUM** e **I-MAGO**.

The most advanced LED technology is combined with the concept of modularity: **QUANTUM** and **I-MAGO**.



2020

La gamma si arricchisce, l'innovazione e le performance crescono nel contesto consolidato di estetica, resistenza e qualità.

The range is enriched, innovation and performance grow in the consolidated context of aesthetics, resistance and quality.





# FINITURE E COLORI PER ARMONIZZARE L'ESTETICA

FINISHES AND COLOURS  
TO SYNC AESTHETICS



Spazio naturale e costruito dialogano nell'ambiente urbano e residenziale, alla ricerca di una continuità.  
Goccia Illuminazione propone soluzioni mirate e affidabili con finiture di pregio ed elevata qualità.

Natural and built space dialogue in the urban and residential environment, seeking continuity.  
Goccia Illuminazione offers targeted and reliable solutions with fine finishes and high quality.

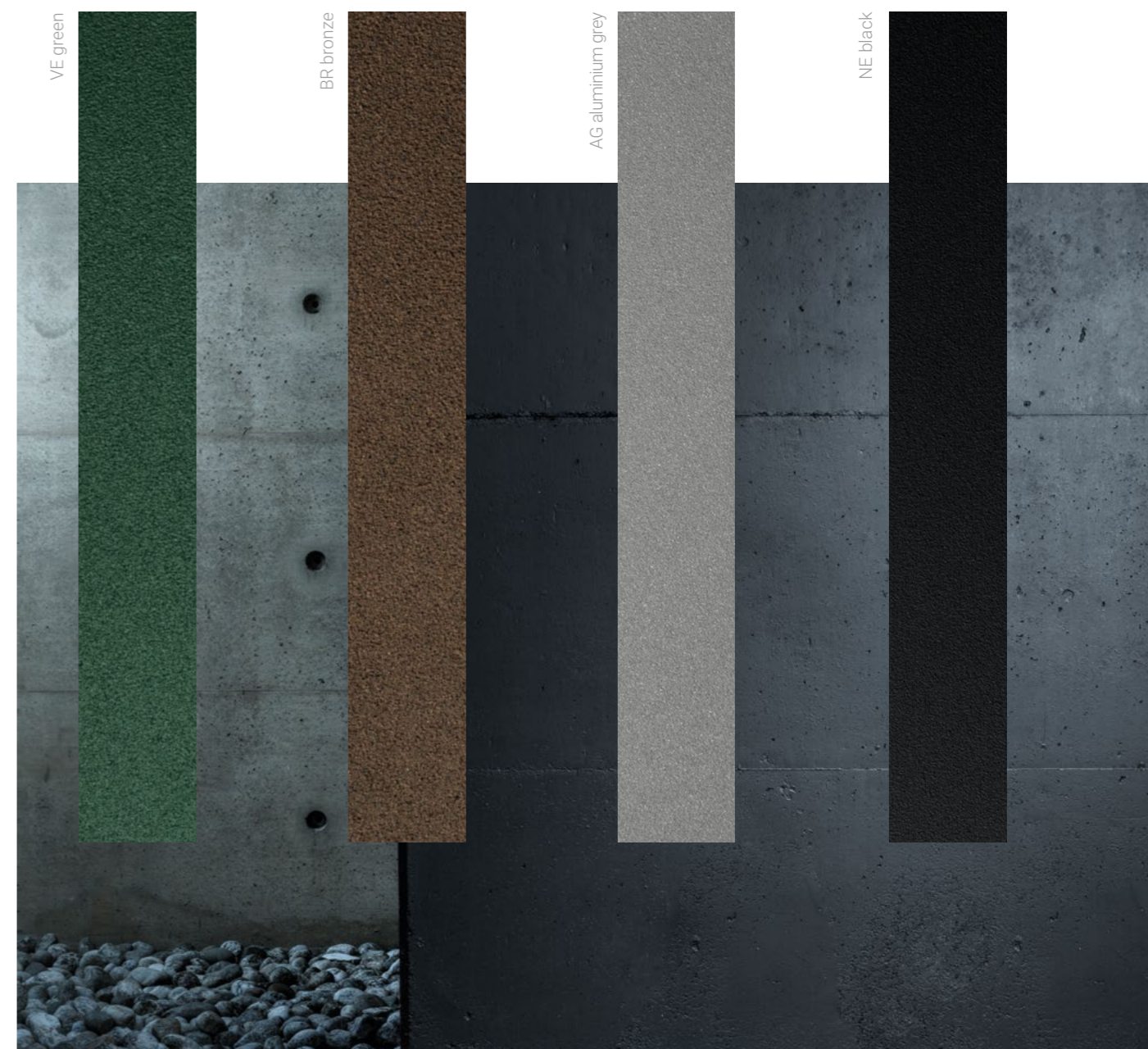



# ACCENDERE SEMPRE NUOVI PERCORSI: UN DIALOGO NELLA LUCE

ALWAYS ENLIGHTENING NEW PATHS:  
A DIALOGUE IN THE LIGHT

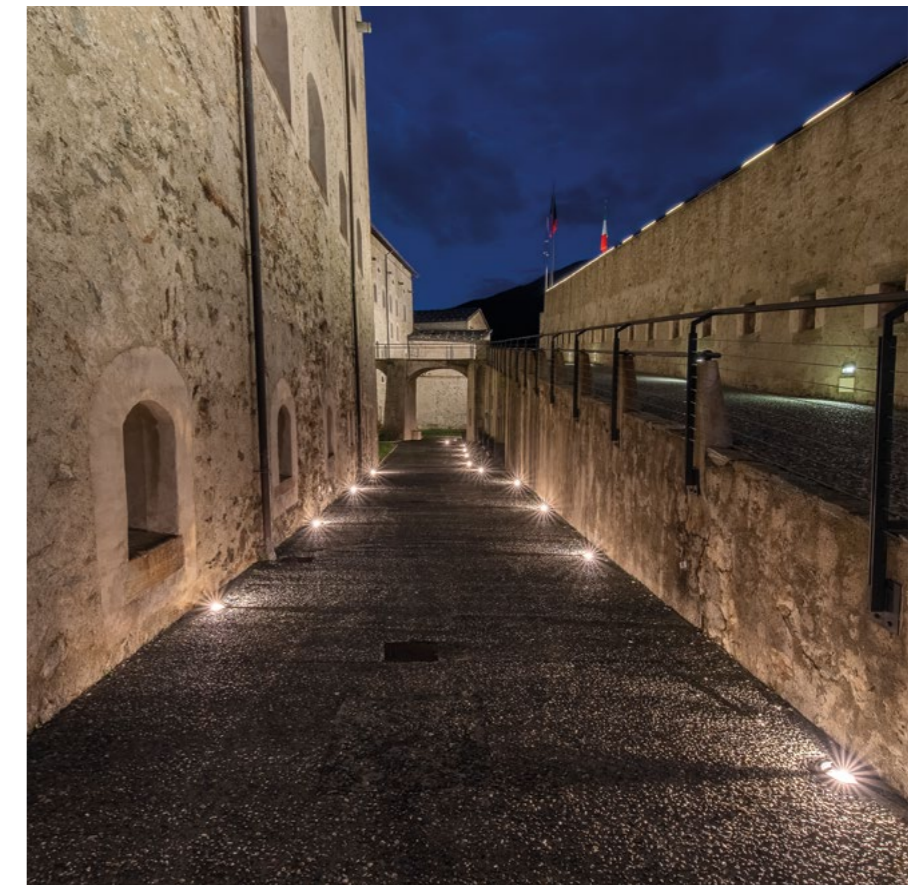

Ogni lampada che Goccia Illuminazione sviluppa trova completamento nella sua realizzazione. Da qui comincia un altro viaggio che la porta al punto dove sarà installata e accesa, un punto che a sua volta diventa nuovo completamento e destinazione: una terrazza, un sottopasso, un giardino, un viale alberato. Una lampada per l'esterno - questa la sua natura - al confine tra lo spazio chiuso e quello aperto, oppure lungo la via tra luoghi diversi. È qui che prosegue il suo viaggio, con chi in questa luce cammina, si ferma per qualche tempo, torna a casa. Questo percorso significa una attenzione continua nel tempo ad ognuna delle diverse fasi. Lo tracciamo con la passione dei colleghi in azienda, attraverso la catena di distribuzione, gli architetti, i progettisti e gli installatori. Ogni volta diverso e acceso di novità, è il percorso che ci guida in un entusiasmante dialogo con i momenti, con i luoghi e con le persone.

Each lamp that Goccia Illuminazione develops finds completion in its realization. From here begins another journey that takes it to the point where it will be installed and lit, a point which in turn becomes a new completion and destination: a terrace, an underpass, a garden, a tree-lined avenue. A lamp for the outdoors - this is its nature - on the border between closed and open spaces, or along the way between different places. It is here that its journey goes on, with those who walk in this light, stop for a while, come back home. This path means continuous attention over time to each of the different phases. We trace it with the passion of colleagues in the company, through the distribution chain, architects, designers and installers. Each time different and bright of novelty, it is the path that guides us in an enthusiastic dialogue with the moments, with the places and with the people.



# L'IDEA CREATIVA DIVENTA REALTÀ

CREATIVE IDEAS BECOME REALITY



Nella filiera che va dalla produzione industriale fino alla realizzazione del progetto architettonico pubblico e privato Goccia Illuminazione segue con dedizione ed esperienza clienti ed interessati per lo sviluppo nell'ambito illuminotecnico, con i materiali e i servizi a disposizione.

- Curve fotometriche
- Fotometrie digitali Eulumdat e IES
- Consulenza specifica prodotto
- Consulenza progetto
- Consulenza normative e certificazioni
- Sviluppo calcolo illuminotecnico e render
- Fotoinserimenti e prove RGB
- Richieste illuminotecniche speciali

In the supply chain that goes from industrial production to the realization of the public and private architectural project, Goccia Illuminazione follows with dedication and experience customers and interested parties for the development in the lighting engineering field, with the materials and services available.

- Photometric curves
- Eulumdat and IES digital photometries
- Specific product advice
- Project consulting
- Regulatory advice and certifications
- Lighting calculation and rendering development
- Photo editing and RGB tests
- Special lighting requests

Per assicurare il miglior risultato nel contesto del progetto illuminotecnico, Goccia Illuminazione supporta architetti e lighting designers. In contatto diretto coi progettisti, il nostro ufficio progettazione offre soluzioni e aiuto per la soddisfazione dei clienti. **L'ufficio progettazione sviluppa anche calcoli illuminotecnici dedicati, con rendering di riferimento per applicazioni specifiche.** Sul nostro sito web sono disponibili i dati fotometrici e le curve illuminotecniche per le applicazioni e le serie desiderate, qui potete richiedere senza impegno la nostra collaborazione per il vostro progetto - [goccia.it](http://goccia.it)

To ensure the best result in the context of the lighting project, Goccia Illuminazione supports architects and lighting designers. In direct contact with the designers, our lighting project department offers solutions and help for customer satisfaction. **The lighting project department also develops dedicated lighting calculations, with reference rendering for specific applications.** Photometric data and lighting curves for the desired applications and series are available on our website, here you can request our collaboration for your project without obligation - [goccia.it](http://goccia.it)







## INDICE PER SERIE INDEX BY SERIES

- 168 CANTHARELLUS
- 176 CANTHUS
- 94 CLOCK
- 248 CORINTHIA
- 272 DOCKS
- 136 IANUS
- 198 I-DEA
- 190 I-LUX
- 182 I-MAGO
- 286 JACK
- 212 K<sup>3</sup>
- 278 KASKO
- 260 KYKLO
- 266 LUNETTE
- 254 LUX SHOWER
- 292 MARINA
- 22 PASSUM
- 110 PROTO
- 82 QUANTUM
- 298 RGBW
- 120 SERVER POINT
- 226 SMALL, MIDI, MAXI & SUPERMAXI
- 52 SQUEEZE
- 60 STAMP
- 128 STANDING
- 152 T-LUX
- 236 TRIANGOLO
- 242 VOLTO
- 204 WASH

INDICE PER APPLICAZIONE  
INDEX BY APPLICATION

INCASSI A TERRA / GROUND RECESSED



CALPESTABILI DI SUPERFICIE / GROUND SURFACE MOUNTED



SEGNAPASSO DA INCASSO E SUPERFICIE / RECESSED AND SURFACE MOUNTED STEPLIGHT

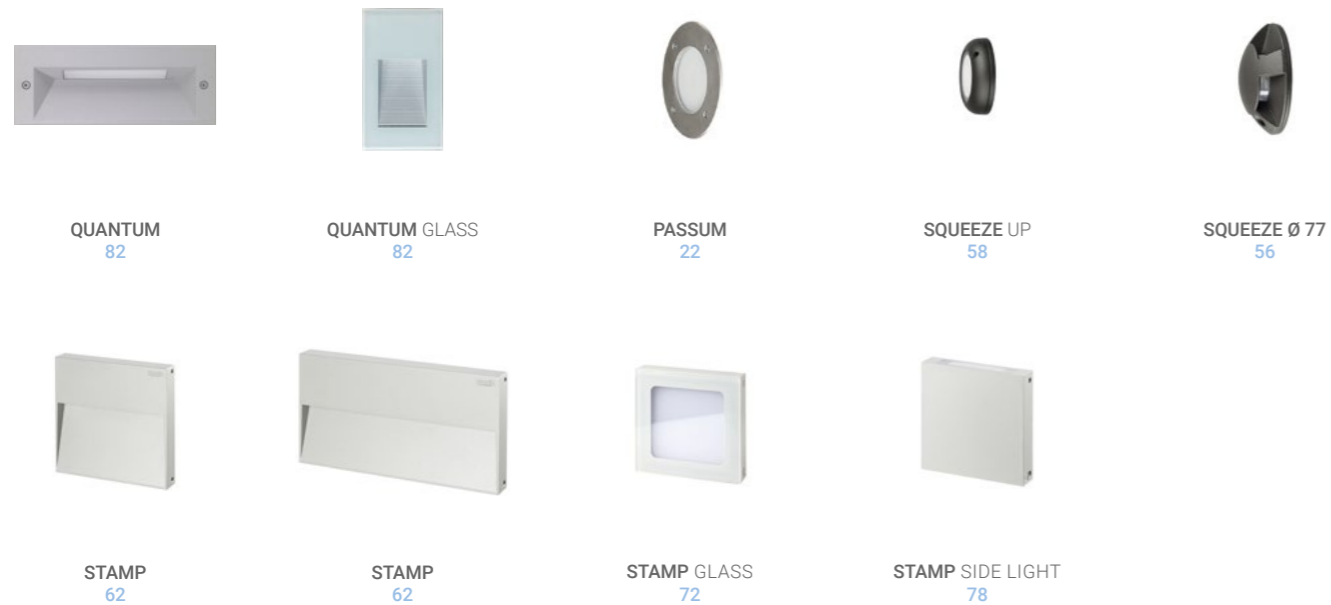

PALI / POSTS

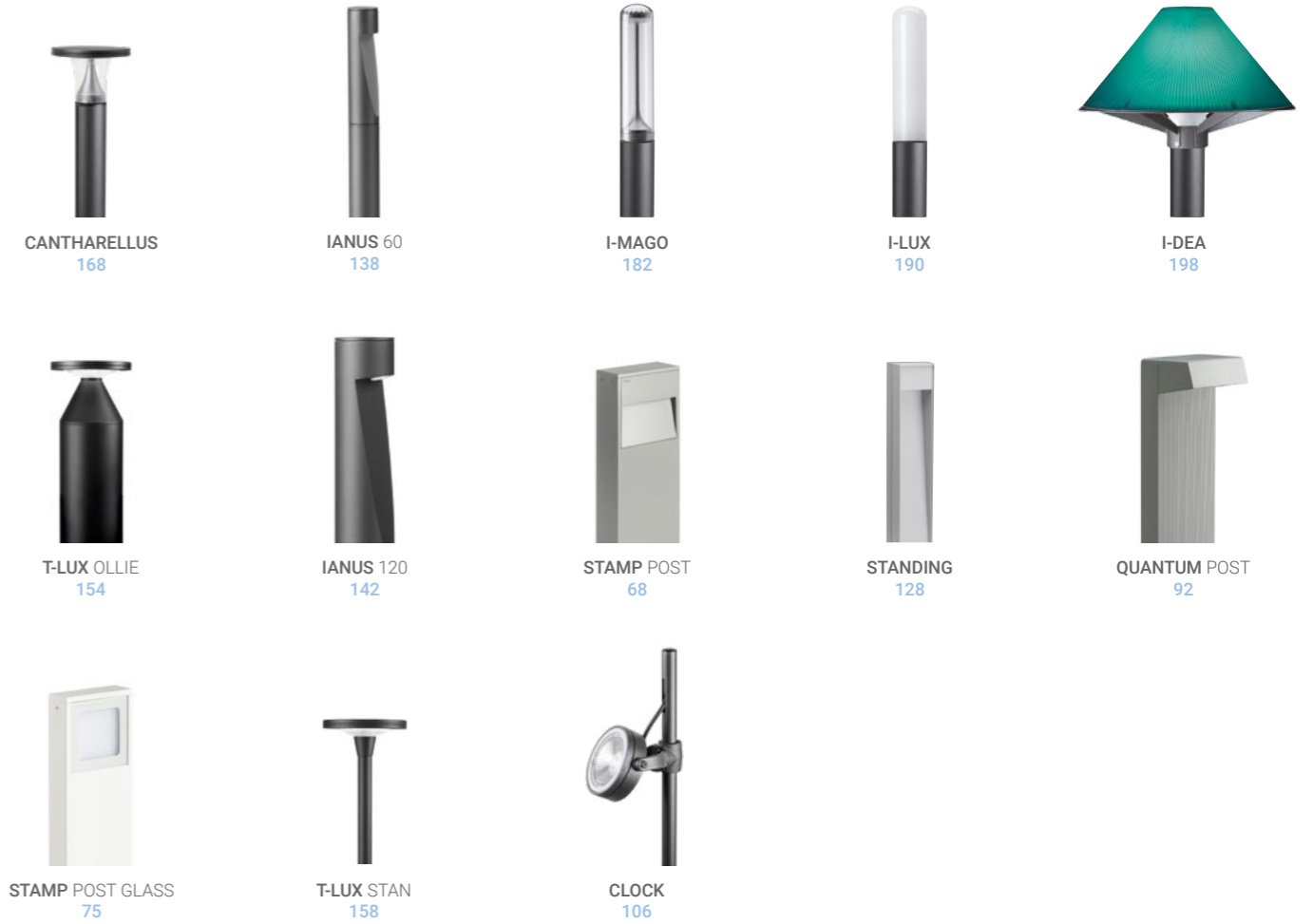

ARREDO URBANO / URBAN LIGHTING





**INDICE PER APPLICAZIONE**  
INDEX BY MOUNTING

EFFETTI A PARETE / WALL EFFECTS



PARETE E SOFFITTO / WALL AND CEILING



PROIETTORI / PROJECTORS



TORRETTE MULTIFUNZIONE / GARDEN POWER POINTS



DOWNLIGHT DA INCASSO E SUPERFICIE / RECESSED AND SURFACE MOUNTED DOWNLIGHT



RGBW



COME LEGGERE IL CATALOGO  
HOW TO READ THE CATALOGUE

Applicazione / Application

Descrizione / Description

Nome serie / Series name

Gamma prodotti / Product range

SPOT PER ESTERNI OUTDOOR SPOTLIGHT

**CLOCK**



Un piccolo proiettore circolare dal design essenziale e di carattere. CLOCK è uno spotlight versatile e preciso. Spessore contenuto ed elegante orientabilità, con le sue due dimensioni offre grande qualità illuminotecnica, grazie ai performanti LED ed alle ottiche accuratamente studiate per permettere svariate modalità di impiego del flusso luminoso. Gli accessori a cono incrementano le tipologie di installazione ed il comfort visivo di CLOCK con stile - soluzioni puntuali per un'illuminazione d'accento scenografico e vibrante.

A small circular projector with an essential design and character. CLOCK is a versatile and precise spotlight. Low thickness and elegant adjustability, with its two dimensions it offers great lighting quality, thanks to the high-performance LEDs and specific designed optics to allow various ways of using the luminous flux. The accessories supplied increase the types of installation and the visual comfort of CLOCK, with style - punctual solutions for scenographic and vibrant accent lighting.

SPOTLIGHT



goccia  
ILLUMINAZIONE

catalogue 2024

Nome prodotto / Product name

Icone / Icons

Applicazione / Application

Disegno quotato / Dimensioned drawing

Informazioni tecniche / Technical information

Note / Notes

**CLOCK**  
Accessori / Accessories

**VISIERA / SHIELD**



Code	Description	Ref. to
4668	● AN - antracite	code 4661
4669	● AG - aluminum grey	code 4664
	● VE - green	code 4665

Visiera in acciaio inox verniciato / Shield in painted stainless steel

**PICCHETTO / SPIKE**



Code	Description	Ref. to
4691	● AN - antracite	code 4661
	● AG - aluminum grey	code 4664
	● VE - green	code 4665

Picchetto da giardino in polycarbonato / Garden spike in polycarbonato

Altezza da terra consigliata: 10 cm come da normativa / Recommended height above ground: 10 cm in compliance with regulation. Il cavo può passare nell'apposito foro della base e nella struttura del picchetto. / The cable can pass through a special hole in the base and through the structure of the spike.

**BRACCIO A MURO / WALL ARM**



Code	Description	Ref. to
4692	● AN - antracite	code 4661
	● AG - aluminum grey	code 4664
	● VE - green	code 4665

Braccio in alluminio / Aluminum arm

Collego ritorno alla base, cabloggio esterno per versioni RGBW / Internal terminal block, external wiring for RGBW versions.

**GIUNTI STAGNI / WATERPROOF CONNECTIONS**



Code	Description
1941	Connessione singola 3x2,5mm <sup>2</sup> IP68 / Single connector 3x2,5 mm <sup>2</sup> IP 68
1942	Connessione entra-esco 3x2,5mm <sup>2</sup> IP68 / Through wiring connector 3x2,5 mm <sup>2</sup> IP 68
1944	Connessione fine a 4 uscite 3x2,5 mm <sup>2</sup> IP68 (basato su gel siliconico bi-componente) / Up to 4 outputs connector 3x2,5 mm <sup>2</sup> IP 68, based on two-component silicone gel.

goccia  
ILLUMINAZIONE

catalogue 2024



Codice prodotto / Product code

Il codice prodotto è composto da:  
**ARTICOLO + FINITURA + TONALITÀ + OTTICA**  
The product code is explained as follows:  
**ITEM + FINISH + TONALITY + OPTIC**

**4664**  
Articolo  
Item

**AN**  
Finitura  
Finish

**3K**  
Tonalità  
Tonality

**12**  
Ottica  
Optic



INCASSI A TERRA,  
A PARETE E  
DOWNLIGHT

GROUND OR WALL  
RECESSED AND  
DOWNLIGHT

# PASSUM



PASSUM è la famiglia di apparecchi da incasso per esterni ad alte prestazioni, con massima tecnologia di illuminazione e straordinaria flessibilità e precisione nell'installazione. Contraddistinta da solidità, perfetta tenuta stagna, resistenza alla corrosione, si articola nelle diverse versioni in alluminio o acciaio inox AISI 316L.

PASSUM UP è la scelta per l'illuminazione da incasso verso l'alto, modulare e componibile secondo le esigenze, dispone inoltre di una versione ad altezza d'installazione minimizzata - ultraflat.

PASSUM SIDEWARDS è la serie per l'illuminazione radente laterale da incasso su percorsi e pavimentazioni. Le alte prestazioni delle unità LED sono ottimizzate dalle ottiche con tecnologia per l'emissione laterale - side emitter.

PASSUM SPOT rappresenta l'applicazione più innovativa della famiglia, grazie ai performanti LED e alle ottiche orientabili che ne fanno un inedito proiettore da incasso a pavimento.

PASSUM DOWNLIGHT è la versione downlight da incasso a soffitto. Il sistema di ganci di fissaggio consente di montare le lampade precablate, grazie alla versione ultraflat anche in altezze limitate.

PASSUM is the family of high performance recessed luminaires for outdoor use, with maximum lighting technology and extraordinary flexibility and precision in installation. Characterized by solidity, perfect watertightness, resistance to corrosion, it is divided into different versions in aluminum or AISI 316L stainless steel.

PASSUM UP is the choice for upward recessed lighting, modular and adaptable according to all needs, it also has a version with minimized installation height - ultraflat.

PASSUM SIDEWARDS is the series for recessed side grazing lighting on paths and pavements. The high performance of the LED units is optimized by the optics with side emitter technology.

PASSUM SPOT represents the most innovative application of the family, thanks to the high-performance LEDs and the adjustable optics that make it a brand new recessed floor projector.

PASSUM DOWNLIGHT is the recessed ceiling downlight version. The fixing hook system allows pre-wired lamps to be mounted, thanks to the ultraflat version even in limited heights.

## GROUND OR WALL RECESSED



PASSUM UP  
Ø 70



PASSUM UP  
Ø 125



PASSUM UP  
Ø 125 ultraflat



PASSUM UP  
Ø 180



PASSUM UP  
Ø 245



PASSUM SIDEWARDS  
Ø 70



PASSUM SIDEWARDS  
Ø 125



PASSUM SIDEWARDS  
Ø 180



PASSUM SPOT  
Ø 180

## CEILING RECESSED



PASSUM DOWNLIGHT  
Ø 70



PASSUM DOWNLIGHT  
Ø 125



PASSUM DOWNLIGHT  
Ø 125 ultraflat



PASSUM DOWNLIGHT  
Ø 180



PASSUM DOWNLIGHT  
Ø 245

# PASSUM UP

## Massima componibilità

Le lampade della serie sono fornite in 3 elementi separati:

- **controcassa da interrare** a ridotto spessore in tecnopolimero
- **corpo lampada** in alluminio o INOX AISI 316L, disponibile in 4 diametri: Ø 70, 125, 180 e 245 mm. Con vetro temperato trasparente, spessore da 6 a 12 mm. Versione Ø 125 ultraflat a basso spessore con vetro opale
- **flange di chiusura intercambiabili**, fornite a parte, tonde in alluminio primario, tonde e quadre in INOX AISI 316L con viti inox a brugola

## Maximum modularity

The lighting fittings of the range are supplied in 3 separate parts:

- low depth **recessing box** in technopolymer
- **light body** in aluminium or AISI 316L stainless steel, available in Ø 70/125/180 and 245 mm. Security tempered glass, thickness from 6 to 12 mm. Ultraflat Ø 125 version with opal glass
- **covering flanges**, supplied separately, available in copper free aluminium or in AISI 316L stainless steel with stainless steel screws

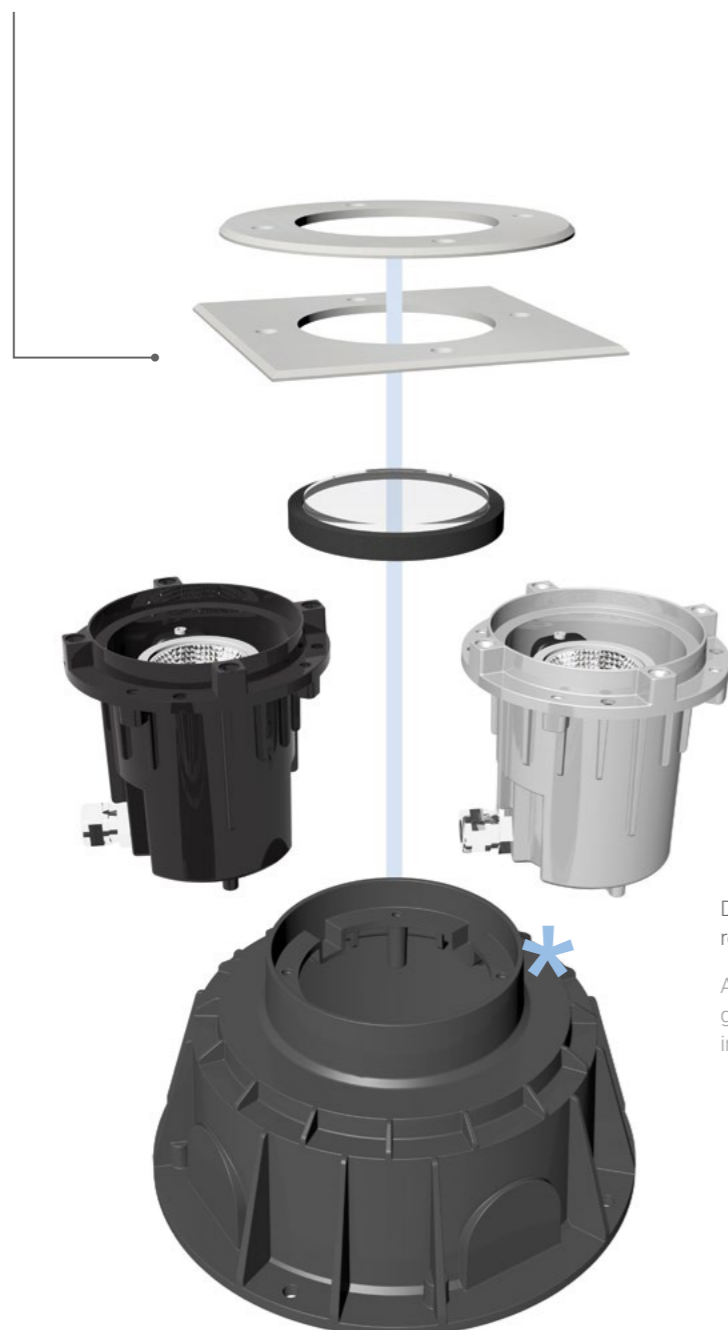

Dopo l'installazione nella cassaforma, è possibile regolare la messa a bolla del corpo lampada.

A complete regulation to align the fitting to the ground is possible even after the recessed box installation.



## Calpestabili e carrabili

Carico massimo da 2.000 a 3.500 kg (1.000 kg per Ø 70 mm).

## Walk over and drive over

Max load 2.000-3.500 kg (1.000 kg for Ø 70 mm).

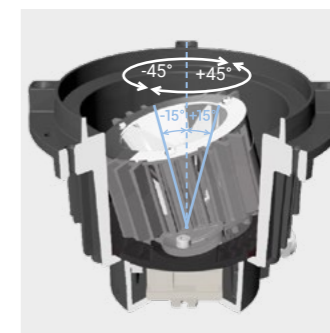

## Ottica basculante e rotante

Lottica delle lampade è basculabile per  $\pm 15^\circ / 25^\circ$  (escluso Ø 70) e ruota sul piano orizzontale per un corretto posizionamento del fascio luminoso.

## Adjustable and rotating optic

Fully adjustable optic (fixed for Ø 70 mm). Vertically  $\pm 15^\circ$  for Ø 125 / 180 mm and  $\pm 15^\circ / \pm 25^\circ$  for Ø 245 mm. Horizontally for the right firing.



## Cavi in dotazione

Fornito con 0,5 m di cavo interrabile H07RN-F per Ø 125 - 180 - 245 (giunti stagni di connessione opzionali da ordinare separatamente - pag. 51). Cavo in silicone 0,2 m con connettori di isolamento termorestringenti per Ø 70.

## Cables supplied

Ø 125 - 180 - 245 fittings are pre-wired with 0,5 m H07RN-F cable (optional waterproof connections to be ordered separately - page 51). Ø 70 fittings are pre-wired with 0,2 m silicone cable and heat-shrinkable insulation connectors.



# PASSUM UP

Incasso a terra o parete / Ground or wall recessed



## CORPI LAMPADA / LIGHT BODIES Ø 70 mm



aluminium



AISI 316L stainless steel

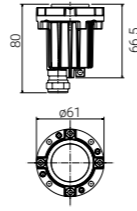

Code	Material	Lamp	W	Lm LED	Real Lm	Optic
1412	aluminium	LED	1	155	88	38°
1413			3	300	162	
1491	AISI 316L stainless steel	LED	1	155	88	38°
1494			3	300	162	

Ottiche opzionali / Optional optics 18° (code + 18), 90° (code + 90)

Driver esterno non compreso / Remote driver to be ordered separately (page 50)

IP 67 con flange / IP 67 with flanges

[Su richiesta / On request](#)

Lunghezza cavo 7 m / 7 m cable length (code + MT7)

## CASSAFORMA / IN-GROUND BOX Ø 70 mm

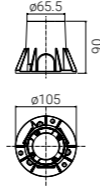

Code	Description
1411	Cassaforma Ø 70 in tecnopolimero da interrare o da parete / In-ground box Ø 70 mm in technopolymer

## FLANGE / FLANGES 70 mm



code 1511



code 1512 IN



code 1513 IN

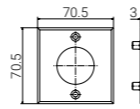
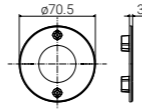

Code	Description
1511	● AN - anthracite ● AG - aluminium grey
1512	● IN - stainless steel
1513	● IN - stainless steel

Description
Flangia tonda Ø 70 in alluminio / Round flange Ø 70 in aluminium
Flangia tonda Ø 70 in acciaio inox AISI 316L / Round flange Ø 70 in AISI 316L stainless steel
Flangia quadrata 70x70 in acciaio inox AISI 316L / Square flange 70x70 in AISI 316L st. steel

[Su richiesta / On request](#)

L'insieme corpo lampada+flangia viene fornito montato, sigillato e orientato / The set light body+flange can be supplied assembled, sealed and oriented

# PASSUM UP

Incasso a terra o parete basso spessore / Ground or wall recessed low depth



## CORPO LAMPADA / LIGHT BODY Ø 125 mm ULTRAFLAT

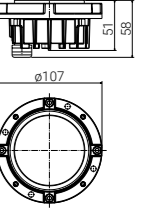

Code	Material	Lamp	W	Lm LED	Real Lm	Optic
1401	aluminium	LED	8	800	347	diffuse
27K - 2700K						
3K - 3000K 4K - 4000K						

Modulo LED a tensione di rete, compatibile con dimmer a taglio di fase / Mains voltage LED module, compatible with most phase-cut dimmers  
IP 67 con flange / IP 67 with flanges

[Su richiesta / On request](#)

24V low voltage (code + 24V)

## CASSAFORMA / IN-GROUND BOX Ø 125 mm ULTRAFLAT

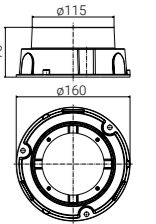

Code	Description
1423	Cassaforma ultraflat Ø 125 mm con profondità di incasso molto contenuta in tecnopolimero / Ultraflat in-ground box Ø 125 mm in technopolymer

## FLANGE / FLANGES 125 mm



code 1521



code 1522 IN



code 1523 IN

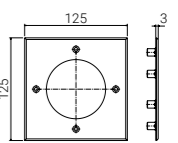
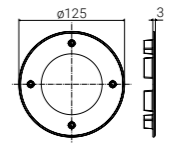

Code	Description
1521	● AN - anthracite ● AG - aluminium grey
1522	● IN - stainless steel
1523	● IN - stainless steel

Description
Flangia tonda Ø 125 in alluminio / Round flange Ø 125 in aluminium
Flangia tonda Ø 125 in acciaio inox AISI 316L / Round flange Ø 125 in AISI 316L stainless steel
Flangia quadrata 125 x 125 in acciaio inox AISI 316L / Square flange 125 x 125 in AISI 316L st. steel

[Su richiesta / On request](#)

L'insieme corpo lampada+flangia viene fornito montato, sigillato e orientato / The set light body+flange can be supplied assembled, sealed and oriented

# PASSUM UP

Incasso a terra o parete / Ground or wall recessed



## CORPI LAMPADA / LIGHT BODIES Ø 125 mm



aluminium AISI 316L stainless steel

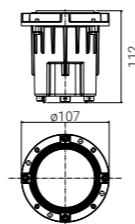

Code	Material	Lamp	W	Lm LED	Real Lm	Optic	
1422	aluminium	27K - 2700K 3K - 3000K 4K - 4000K	LED	8	951	636	38°
1424		-	GU10	5	-	-	-
1495	AISI 316L stainless steel	27K - 2700K 3K - 3000K 4K - 4000K	LED	4	430	289	38°
1496		-	GU10	5	-	-	-

Ottiche opzionali / Optional optics 18° (code + 18), 90° (code + 90)  
 Ottiche basculanti / Adjustable optics 1422, 1495 ±15° / 1424, 1496 ± 8°  
 Versione RGBW (vedi capitolo dedicato) / RGBW version (see related chapter)  
 GU10 L max 57 mm (forniti senza lampadina / supplied without lamp)  
 IP 67 con flange / IP 67 with flanges

**Su richiesta / On request**  
 12-24V low voltage

## CASSAFORMA / IN-GROUND BOX Ø 125 mm

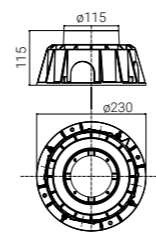

Code	Description
1421	Cassaforma Ø 125 in tecnopolimero da interrare o da parete / In-ground box Ø 125 mm in technopolymer

# PASSUM UP

Incasso a terra o parete / Ground or wall recessed



## FLANGE / FLANGES 125 mm



code 1521



code 1522 IN



code 1523 IN

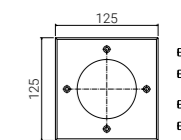
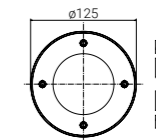

Code	Description
1521	Flangia tonda Ø 125 in alluminio / Round flange Ø 125 in aluminium
1522	Flangia tonda Ø 125 in acciaio inox AISI 316L / Round flange Ø 125 in AISI 316L stainless steel
1523	Flangia quadrata 125 x 125 in acciaio inox AISI 316L / Square flange 125 x 125 in AISI 316L st. steel

### Su richiesta / On request

L'insieme corpo lampada+flangia viene fornito montato, sigillato e orientato /  
 The set light body+flange can be supplied assembled, sealed and oriented





# PASSUM UP

Incasso a terra o parete / Ground or wall recessed



## CORPI LAMPADA / LIGHT BODIES Ø 180 mm



aluminium AISI 316L stainless steel

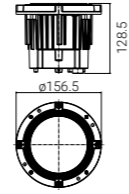

Code	Material	Lamp	W	Lm LED	Real Lm	Optic
1432	aluminium	LED	11	1405	1060	38°
1433			16	2643	1819	
1434	AISI 316L stainless steel	GU10	7-8	-	-	-
1497		LED	8	951	636	38°
1498	AISI 316L stainless steel	GU10	7-8	-	-	-

Ottiche opzionali / Optional optics 18° (code + 18), 90° (code + 90)

Ottiche basculanti / Adjustable optics ±15°

Versione RGBW (vedi capitolo dedicato) / RGBW version (see related chapter)

GU10 L max 86 mm (forniti senza lampadina / supplied without lamp)

IP 67 con flange / IP 67 with flanges

## CASSAFORMA / IN-GROUND BOX Ø 180 mm

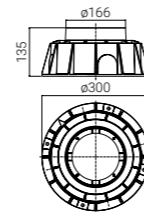

Code	Description
1431	Cassaforma Ø 180 mm in tecnopolimero da interrare o da parete / In-ground box Ø 180 mm in technopolymer

# PASSUM UP

Incasso a terra o parete / Ground or wall recessed



## FLANGE / FLANGES 180 mm



code 1531



code 1532 IN



code 1533 IN

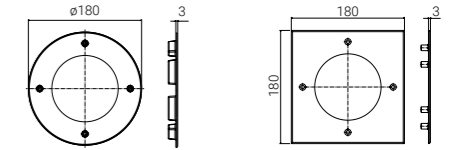

Code	Description
1531	Flangia tonda Ø 180 in alluminio / Round flange Ø 180 in aluminium
1532	Flangia tonda Ø 180 in acciaio inox AISI 316L / Round flange Ø 180 in AISI 316L stainless steel
1533	Flangia quadrata 180 x 180 in acciaio inox AISI 316L / Square flange 180 x 180 in AISI 316L st. steel

### Su richiesta / On request

L'insieme corpo lampada+flangia viene fornito montato, sigillato e orientato / The set light body+flange can be supplied assembled, sealed and oriented





## PASSUM UP

Incasso a terra / Ground recessed



### CORPI LAMPADA / LIGHT BODIES Ø 245 mm



code 1440



code 1442

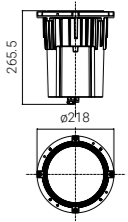

	Code	Material	Lamp	W	Lm LED	Real Lm	Optic
1440	27K - 2700K	aluminium	LED	23	3329	2434	38°
	3K - 3000K			29,5	4215	3180	
1442	4K - 4000K		E27	30	-	-	-
1444	-						

Ottiche opzionali / Optional optics

1440, 1442 18° (code + 18), 1440 70° (code + 70), 1442 90° (code + 90)

Ottiche basculanti / Adjustable optics 1440 ±15°, 1442, 1444 ±25°

Versione RGBW (vedi capitolo dedicato) / RGBW version (see related chapter)

E27 L max 195 mm (fornito senza lampadina / supplied without lamp)

IP 67 con flange / IP 67 with flanges

**Su richiesta / On request**

Versione dimmerabile / Dimmable version

### CASSAFORMA / IN-GROUND BOX Ø 245 mm

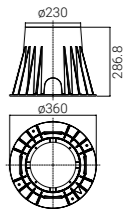

Code

Description

1441

Cassaforma Ø 245 mm in tecnopolimero da interrare / In-ground box Ø 245 mm in technopolymer

### FLANGE / FLANGES Ø 245 mm



code 1541



code 1542 IN

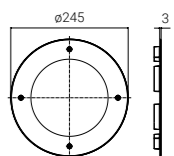

	Code	Description
1541	AN - anthracite	Flangia tonda Ø 245 in alluminio / Round flange Ø 245 in aluminium
	AG - aluminium grey	
1542	IN - stainless steel	Flangia tonda Ø 245 in acciaio inox AISI 316L / Round flange Ø 245 in AISI 316L stainless steel

Code	Description
1541	Flangia tonda Ø 245 in alluminio / Round flange Ø 245 in aluminium
1542	Flangia tonda Ø 245 in acciaio inox AISI 316L / Round flange Ø 245 in AISI 316L stainless steel

**Su richiesta / On request**

L'insieme corpo lampada+flangia viene fornito montato, sigillato e orientato / The set light body+flange can be supplied assembled, sealed and oriented



## PASSUM SIDEWARDS



### Calotte intercambiabili

Sono fornite a parte con diverse possibilità di orientare la luce radente e finiture.

### Changeable canopies

The covering canopies, in different finishing, allow several light emissions.



Dopo l'installazione nella cassaforma, è possibile regolare la messa a bolla del corpo lampada.

A complete regulation to align the fitting to the ground is possible even after the recessed box installation.

### Massima componibilità

Le lampade della serie sono fornite in 3 elementi separati:

- **controcassa da interrare** a ridotto spessore in tecnopolimero
- **corpo lampada** in alluminio o INOX AISI 316L, disponibile in 3 diametri: Ø 70, 125 e 180 mm. Diffusore in policarbonato anti UV
- **calotte di chiusura**, fornite a parte, con diverse possibilità di illuminazione radente: singola, doppia 2x90°, 180° e 360°

### Maximum modularity

The lighting fittings of the range are supplied in 3 separate parts:

- low depth **recessing box** in technopolymer
- **light body** in aluminium or AISI 316L stainless steel, available in Ø 70/125 and 180 mm. UV resistant polycarbonate diffuser
- **covering canopies**, supplied separately, available in different emissions: 90°, 2x90°, 180° and 360°

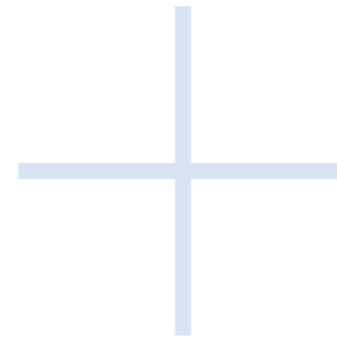

### Calpestabili e carrabili

T<sub>s</sub> ≤ 40°C. Carico massimo 2.000 kg.

### Walk over and drive over

Surface T<sub>s</sub> ≤ 40°C and max load 2.000 kg.



### Ottica side emitter

LED con ottica side emitter progettata per deviare tutta la luce radente sui lati.

### Side emitter optic

The lens directs the light along the ground surface.



### Cavi in dotazione

Fornito con 0,5 m di cavo interrabile H07RN-F per Ø 125 - 180 (giunti stagni di connessione opzionali da ordinare separatamente - pag. 51). Cavo in silicone 0,2 m con connettori di isolamento termorestringenti per Ø 70.

### Cables supplied

Ø 125 - 180 fittings are pre-wired with 0,5 m H07RN-F cable (optional waterproof connections to be ordered separately - page 51). Ø 70 fittings are pre-wired with 0,2 m silicone cable and heat-shrinkable insulation connectors.

# PASSUM SIDEWARDS

Incasso a terra o parete / Ground or wall recessed



## CORPI LAMPADA / LIGHT BODIES Ø 70 mm



aluminium



AISI 316L stainless steel

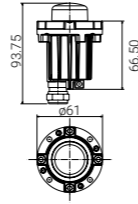

Code	Material	Lamp	W	Lm LED	Real Lm	Optic
1415	aluminium	LED	1	155	1x33	-
1416			3	300	1x65	
1481	AISI 316L stainless steel	LED	1	155	1x33	-
1484			3	300	1x65	

Driver esterno non compreso / Remote driver to be ordered separately (page 50)  
IP 67 con calotte / IP 67 with canopies

**Su richiesta / On request**  
Lunghezza cavo 7 m / 7 m cable length (code + **MT7**)

## CASSAFORMA / IN-GROUND BOX Ø 70 mm

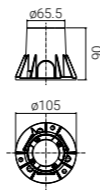

Code	Description
1411	Cassaforma Ø 70 in tecnopolimero da interrare o da parete / In-ground box Ø 70 mm in technopolymer

# PASSUM SIDEWARDS

Incasso a terra o parete / Ground or wall recessed



## CALOTTE DI CHIUSURA / COVERING CANOPIES Ø 70 mm



code 1515



code 1516

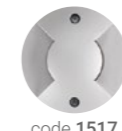

code 1517



code 1519

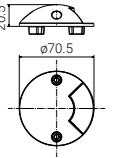

code 1591 IN



code 1593 IN



code 1594 IN

Code	Description
1515	Calotta 1x90° in alluminio / Canopy 1x90° in aluminium
1516	Calotta 180° in alluminio / Canopy 180° in aluminium
1517	Calotta 2x90° in alluminio / Canopy 2x90° in aluminium
1519	Calotta 360° in alluminio / Canopy 360° in aluminium
1591	Calotta 1x90° in acciaio inox AISI 316L / Canopy 1x90° in AISI 316L stainless steel
1593	Calotta 2x90° in acciaio inox AISI 316L / Canopy 2x90° in AISI 316L stainless steel
1594	Calotta 360° in acciaio inox AISI 316L / Canopy 360° in AISI 316L stainless steel

1515, 1516, 1517, 1519 Carico max. / Max load 2.000 kg  
1591, 1593, 1594 Carico max. / Max load 500 kg

**Su richiesta / On request**  
L'insieme corpo lampada+calotta viene fornito montato e sigillato /  
The set light body+canopy can be supplied assembled and sealed

code 1427 + 1525



# PASSUM SIDEWARDS

Incasso a terra o parete / Ground or wall recessed



## CORPI LAMPADA / LIGHT BODIES Ø 125 mm

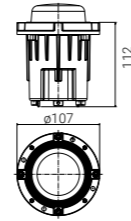

Code	Material	Lamp	W	Lm LED	Real Lm	Optic
1427	aluminium	LED	4	430	1x68	-
1485	AISI 316L stainless steel					

IP 67 con calotte / IP 67 with canopies

Su richiesta / On request  
12-24V low voltage (code + LV)

## CASSAFORMA / IN-GROUND BOX Ø 125 mm

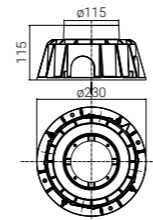

Code	Description
1421	Cassaforma Ø 125 in tecnopolimero da interrare o da parete / In-ground box Ø 125 mm in technopolymer

## CALOTTE DI CHIUSURA / COVERING CANOPIES Ø 125 mm

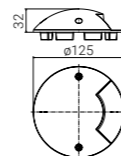

Code	Description
1525	Calotta 1x90° in alluminio / Canopy 1x90° in aluminium
1526	Calotta 180° in alluminio / Canopy 180° in aluminium
1527	Calotta 2x90° in alluminio / Canopy 2x90° in aluminium
1529	Calotta 360° in alluminio / Canopy 360° in aluminium

Su richiesta / On request  
L'insieme corpo lampada+calotta viene fornito montato e sigillato /  
The set light body+canopy can be supplied assembled and sealed

# PASSUM SIDEWARDS

Incasso a terra o parete / Ground or wall recessed



## CORPI LAMPADA / LIGHT BODIES Ø 180 mm

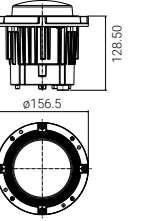

Code	Material	Lamp	W	Lm LED	Real Lm	Optic
1436	aluminium	LED	11	1405	1x86	-
1487	AISI 316L stainless steel					

IP 67 con calotte / IP 67 with canopies

## CASSAFORMA / IN-GROUND BOX Ø 180 mm

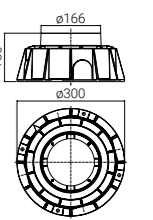

Code	Description
1431	Cassaforma Ø 180 mm in tecnopolimero da interrare o da parete / In-ground box Ø 180 mm in technopolymer

## CALOTTE DI CHIUSURA / COVERING CANOPIES Ø 180 mm

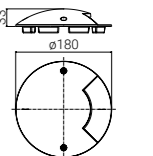
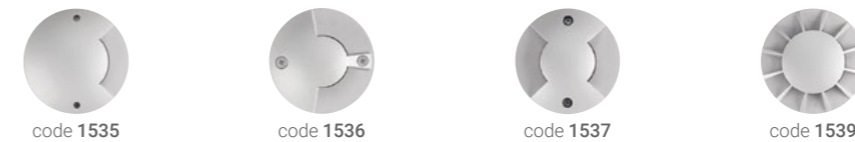

Code	Description
1535	Calotta 1x90° in alluminio / Canopy 1x90° in aluminium
1536	Calotta 180° in alluminio / Canopy 180° in aluminium
1537	Calotta 2x90° in alluminio / Canopy 2x90° in aluminium
1539	Calotta 360° in alluminio / Canopy 360° in aluminium

Su richiesta / On request  
L'insieme corpo lampada+calotta viene fornito montato e sigillato /  
The set light body+canopy can be supplied assembled and sealed

# PASSUM SPOT

## Prodotto completo

Le lampade della serie sono fornite assemblate:

- **corpo lampada** in alluminio o acciaio INOX AISI 316L. Diffusore in policarbonato anti UV
- **calotta di chiusura** in alluminio primario a doppia verniciatura



## Complete product

The lighting fittings of the range are supplied assembled:

- **light body** in aluminium or AISI 316L stainless steel. UV resistant polycarbonate diffuser
- **covering canopy** in aluminium with double layer of powder painting



## Controcassa

Controcassa da interrare a ridotto spessore in tecnopolimero.

## In-ground box

Low depth **recessing box** in technopolymer.

Dopo l'installazione nella cassaforma, è possibile regolare la messa a bolla del corpo lampada.

A complete regulation to align the fitting to the ground is possible even after the recessed box installation.

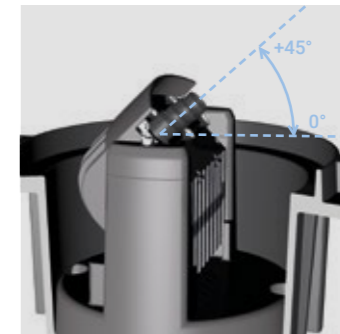
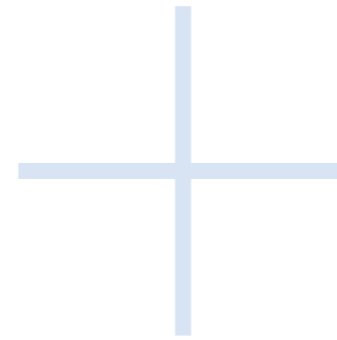

## Ottica orientabile

Il gruppo ottico è facilmente regolabile sul piano verticale e consente di orientare la luce da 0° a +45° nella direzione desiderata.

## Adjustable optic

The optic unit is easily adjustable and permits to orient the light at the ground surface until 45° upwards.





# PASSUM SPOT

Incasso a terra o parete / Ground or wall recessed



## LAMPADE CON CALOTTA E LUCE ORIENTABILE / LUMINAIRES WITH CANOPY AND ADJUSTABLE OPTIC Ø 180 mm

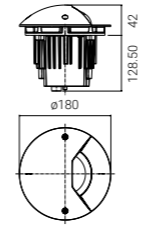

Code			Material	Lamp	W	Lm LED	Real Lm	Optic
1438	● AN - anthracite	3K - 3000K	aluminium body	LED	8	850	605	40°
1488	● AG - aluminium grey	4K - 4000K	AISI 316L st. steel body					

Ottiche opzionali / Optional optics 12° (code + 12)  
 Ottiche orientabili / Adjustable optics 0° +45°

## CASSAFORMA / IN-GROUND BOX Ø 180 mm

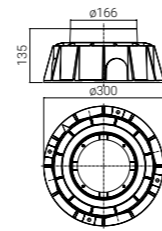

Code	Description
1431	Cassaforma Ø 180 mm in tecnopolimero da interrare o da parete / In-ground box Ø 180 mm in technopolymer



# PASSUM DOWNLIGHT

## Struttura

Corpo lampada in alluminio primario a basso contenuto di rame, verniciato con polveri poliestere anticorrosione dopo fosfocromatazione. Vetro temperato trasparente o opale a richiesta; spessore da 6 a 12 mm.

Disponibile in 4 diametri: Ø 70, 125, 180 e 245 mm **forniti con flange di chiusura** in alluminio (flange INOX tonde o quadrate a richiesta). Versione Ø 125 ultraflat a basso spessore con vetro opale.

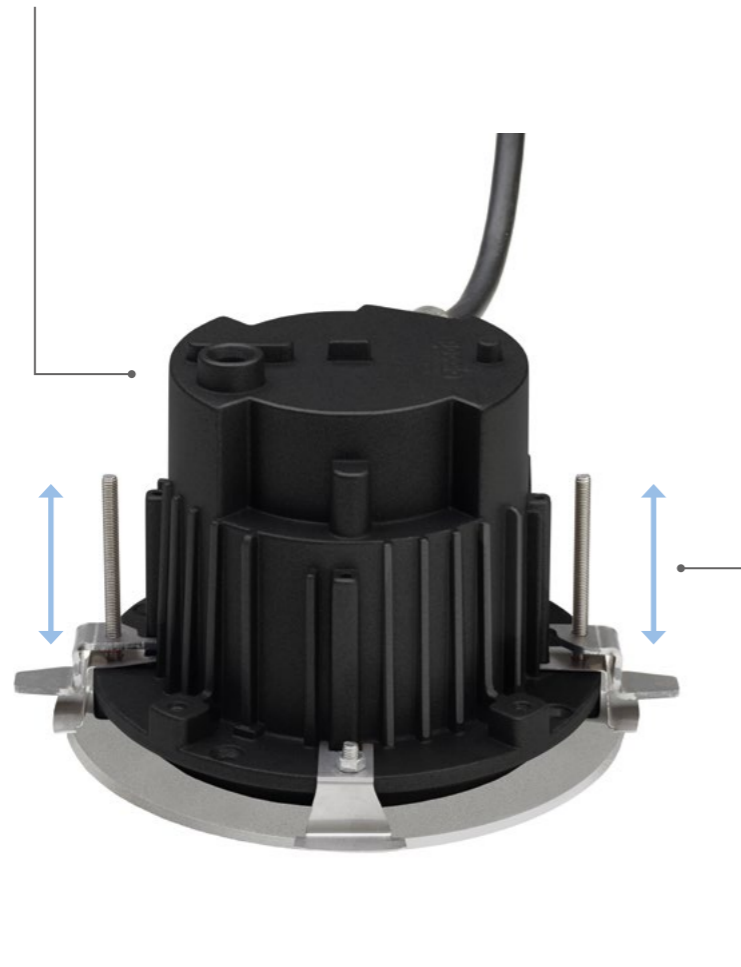

## Structure

Lamp body in low copper content primary aluminium with pre-phosphochrome corrosion protection polyester powder coating. Transparent tempered glass, opal upon request, thickness from 6 to 12 mm.

Available in 4 diameters: Ø 70, 125, 180 and 245 mm **supplied with aluminium closing flanges** (round or square stainless steel flanges upon request). Ultraflat Ø 125 version with opal glass.

## Staffe di fissaggio

Staffe di fissaggio in dotazione per spessori da 5 a 50 mm. Avvitando le viti di bloccaggio in senso orario, le staffe si dispongono nella posizione di aggancio fino a serrare l'apparecchio al controsoffitto.

## Fastening brackets

Fastening brackets supplied, for thicknesses from 5 to 50 mm. Tighten the locking screws in the clockwise direction to arrange the hooking position until the fitting is secured to the false ceiling.

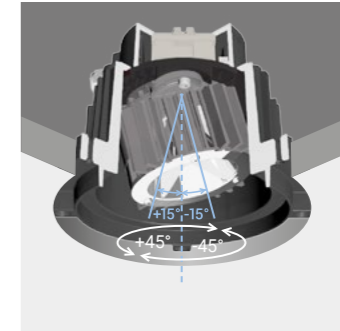
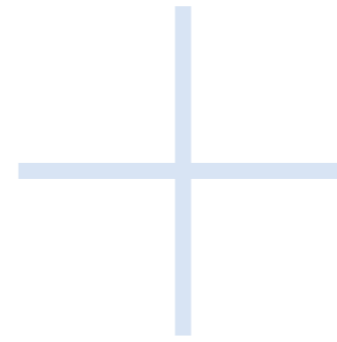

## Ottica basculante e rotante

L'ottica delle lampade è basculabile per  $\pm 15^\circ / 25^\circ$  (escluso Ø 70) e ruota sul piano orizzontale per un corretto posizionamento del fascio luminoso.

## Adjustable and rotating optic

Fully adjustable optic (fixed for Ø 70 mm). Vertically  $\pm 15^\circ$  for Ø 125 / 180 mm and  $\pm 15^\circ / \pm 25^\circ$  for Ø 245 mm. Horizontally for the right firing.



## Cavi in dotazione

Fornito con 0,5 m di cavo H07RN-F per Ø 125 - 180 - 245. Cavo in silicone 0,2 m con connettori di isolamento termorestringenti per Ø 70.

## Cables supplied

Ø 125 - 180 - 245 fittings are pre-wired with 0,5 m H07RN-F cable. Ø 70 fittings are pre-wired with 0,2 m silicone cable and heat-shrinkable insulation connectors.

# PASSUM DOWNLIGHT

Incasso a soffitto / Ceiling recessed

CRI 80 IP 65 IP 67 UK CA CE

## LAMPADA / LUMINAIRE Ø 70 mm

24V DC IK 08

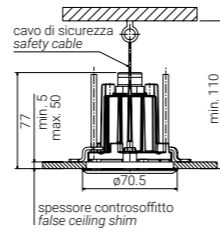

Code		
1470	● AN - anthracite	27K - 2700K
	● 3K - 3000K	
	● AG - aluminium grey	4K - 4000K

Lamp	W	Lm LED	Real Lm	Optic
LED	3	300	162	38°

Ottiche opzionali / Optional optics 18° (code + 18), 90° (code + 90)  
 Driver esterno non compreso / Remote driver to be ordered separately (page 50)  
 Foro controsoffitto / False ceiling hole Ø min. 65 mm - Ø max. 66 mm

**Su richiesta / On request**  
 ● IN - stainless steel

# PASSUM DOWNLIGHT

Incasso a soffitto / Ceiling recessed

230V 50Hz IP 65 IP 67 IK 10 UK CA CE

## LAMPADA / LUMINAIRE Ø 125 mm ultraflat

CRI ≥ 80

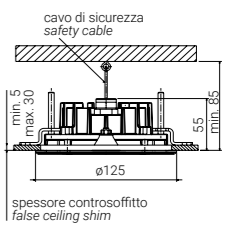

Code		
1479	● AN - anthracite	27K - 2700K
	● 3K - 3000K	
	● AG - aluminium grey	4K - 4000K

Lamp	W	Lm LED	Real Lm	Optic
LED	8	800	347	diffuse

Modulo LED a tensione di rete, compatibile con dimmer a taglio di fase /  
 Mains voltage LED module, compatible with most phase-cut dimmers  
 Foro controsoffitto / False ceiling hole Ø min. 115 mm - Ø max. 116 mm

**Su richiesta / On request**  
 24V low voltage (code + 24V)  
 ● IN - stainless steel

## LAMPADE / LUMINAIRES Ø 125 mm

230V 50Hz IK 10

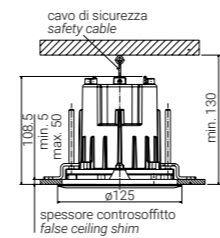

Code		
1472	● AN - anthracite	27K - 2700K
	● 3K - 3000K	
	● AG - aluminium grey	4K - 4000K
1473	-	-

Lamp	W	Lm LED	Real Lm	Optic
LED	8	951	636	38°
GU10	5	-	-	-

Ottiche opzionali / Optional optics 18° (code + 18), 90° (code + 90)  
 Ottiche basculanti / Adjustable optics 1472 ±15°, 1473 ±8°  
 GU10 L max 57 mm (fornita senza lampadina / supplied without lamp)  
 Foro controsoffitto / False ceiling hole Ø min. 115 mm - Ø max. 116 mm

**Su richiesta / On request**  
 12-24V low voltage  
 Versione RGBW / RGBW version  
 ● IN - stainless steel

## LAMPADE / LUMINAIRES Ø 180 mm

CRI 80

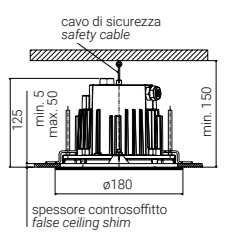

Code		
1474	● AN - anthracite	27K - 2700K
	● 3K - 3000K	
	● AG - aluminium grey	4K - 4000K
1475	-	-

Lamp	W	Lm LED	Real Lm	Optic
LED	11	1405	1060	38°
	16	2643	1819	

Ottiche opzionali / Optional optics 18° (code + 18), 90° (code + 90)  
 Ottiche basculanti / Adjustable optics ±15°  
 Foro controsoffitto / False ceiling hole Ø min. 164 mm - Ø max. 165 mm

**Su richiesta / On request**  
 Versione RGBW / RGBW version  
 ● IN - stainless steel

# PASSUM DOWNLIGHT

Incasso a soffitto / Ceiling recessed



LAMPADE / LUMINAIRES Ø 245 mm

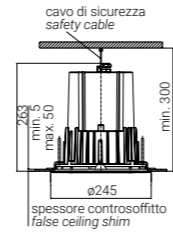

## Code

Code		
1471	● AN - anthracite	27K - 2700K
		3K - 3000K
1476	● AG - aluminium grey	4K - 4000K
		-
1478		-

Lamp	W	Lm LED	Real Lm	Optic
LED	23	3329	2434	38°
	29,5	4215	3180	
E27	30	-	-	-

Ottiche opzionali / Optional optics

1471,1476 18° (code + **18**), 1471 70° (code + **70**), 1476 90° (code + **90**)

Ottiche basculanti / Adjustable optics 1471 ±15°, 1476,1478 ±25°

E27 L max 195 mm (fornita senza lampadina / supplied without lamp)

Foro controsoffitto / False ceiling hole Ø min. 225 mm - Ø max. 226 mm

## Su richiesta / On request

Versione dimmerabile / Dimmable version

Versione RGBW / RGBW version

● IN - stainless steel





ALIMENTATORI 24V DC / 24V DC CONTROL GEARS

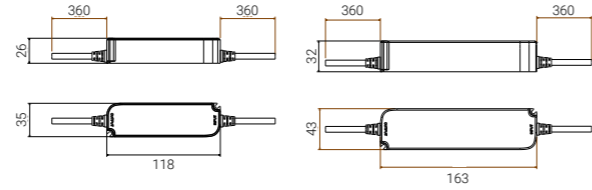

code 1924

code 1925

Code	W	Description
1924	24	INPUT 220-240 V - OUTPUT 24V DC
1925	60	

1924 controlla da 1 a 7 apparecchi PASSUM Ø 70 mm / controls from 1 to 7 luminaires PASSUM Ø 70 mm

1925 controlla da 8 a 18 apparecchi PASSUM Ø 70 mm / controls from 8 to 18 luminaires PASSUM Ø 70 mm

GIUNTI STAGNI / WATERPROOF CONNECTIONS



code 1941



code 1942

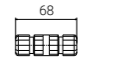

code 1941

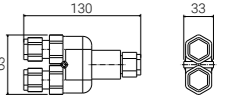

code 1942



code 1944

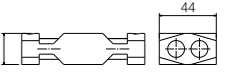

code 1944

Code	Description
1941	Connessione singola 3x2,5 mm <sup>2</sup> IP68 / Single connector 3x2,5 mm <sup>2</sup> IP 68
1942	Connessione entra-esci 3x2,5 mm <sup>2</sup> IP68 / Through wiring connector 3x2,5 mm <sup>2</sup> IP 68
1944	Connessione fino a 4 uscite 3x2,5 mm <sup>2</sup> IP68 (basato su gel silconico bicomponente) / Up to 4 outputs connector 3x2,5 mm <sup>2</sup> IP 68, based on two-component silicone gel



GRIGLIE ANTIABBAGLIANTI PER PASSUM UP / PASSUM UP ANTIGLARE LOUVERS



code 1971



code 1972

Code	Description	Ref. to
1971	Frangiluce / Antiglare louver PASSUM UP Ø 180	code 1432 code 1433
1972	Frangiluce / Antiglare louver PASSUM UP Ø 245	code 1442



CALPESTABILI DI  
SUPERFICIE

GROUND SURFACE  
MOUNTED

# SQUEEZE



La luce architettonica a pavimento permette un'atmosfera di grande suggestione senza essere invasiva, sia per i grandi progetti illuminotecnici, come per le piccole installazioni. Sulla base di questa consolidata esperienza nasce SQUEEZE, la serie di apparecchi calpestabili senza incasso. Senza bisogno di installare in profondità i componenti, o di lavorare le pavimentazioni, la sua flessibilità di impiego raggiunge nuovi scenari di illuminazione, anche nel contesto esistente. Questo è possibile grazie al contenimento di una tecnologia altamente performante, disponibile in diverse modalità illuminotecniche entro le dimensioni ridotte al minimo. Sprigiona nuove tracce di luce.

Architectural ground lighting creates a highly suggestive ambience with minimum invasiveness, both for major lighting projects and small installations. SQUEEZE, the range of surface mounted ground lights, has been designed based on this consolidated experience. Without the need for recessed installation or flooring works, its flexibility of use achieves new lighting scenarios, even within the existing context. This is possible as it contains a high performance technology available in different and characteristic illuminating options, all minimum in size. To unleash new traces of light.

## GROUND SURFACE MOUNTED



SQUEEZE  
Ø 77



SQUEEZE  
Ø 180



SQUEEZE UP  
Ø 59



# SQUEEZE

## Struttura

Solida struttura in alluminio pressofuso a basso tenore di rame e viti inox. Sorgenti LED dedicate e diffusori in policarbonato anti UV.

## Structure

Low copper content die-cast aluminium solid structure and stainless steel screws. Dedicated LED sources and anti UV polycarbonate diffusers.



Fornito con 1,5 m di cavo interrabile in poliuretano 2x0,8 per 24V; 3x1 H07RN-F per 230V.

Comes with 1,5 m polyurethane buriable cable 2x0,8 for 24V; 3x1 H07RN-F for 230V.

## ACQUASTOP

Resinatura speciale in corrispondenza dell'ingresso cavi per una tenuta stagna completa. Passacavo in alluminio anticorrosione anodizzato.

## AQUASTOP

Special resin coating at cable entry for complete watertight hold. Anticorrosion anodized aluminium cable gland.

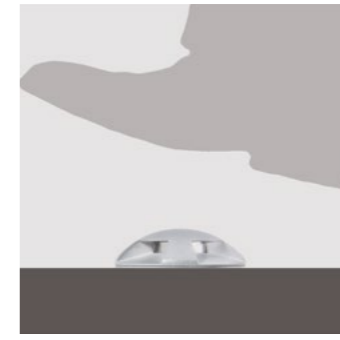
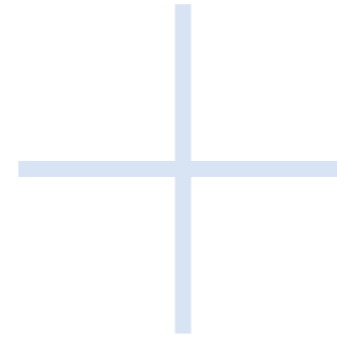

## Calpestabili

Resistente struttura in alluminio calpestabile fino a 500 kg.

## Walk over

Resistant aluminium ground structure with up to 500 kg weight capacity.



## Schermatura antiabbagliante

Sorgente luminosa recessa nella versione a luce laterale per una riduzione efficace dell'abbagliamento diretto.

## Anti-glare shielding

Recessed light source in the side light version for the effective reduction of direct dazzle.



## Installazione a superficie

Nelle versioni a dimensione ridotta Ø 59 e 77 mm converter 24V resinato nel cilindro passacavo, inseribile nel tubo corrugato. Versione Ø 180 mm totalmente a superficie.

## Ground surface installation

In the smaller versions Ø 59 and 77 mm resin coated 24V converter in the cable gland cylinder, which can be inserted in the installation tube. Ø 180 mm version totally flush with the ground.

# SQUEEZE

Calpestabile di superficie / Ground surface mounted



## SQUEEZE Ø 77 mm 24V

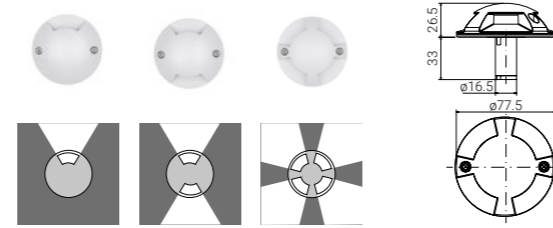

Code		
1453	● AN - anthracite	27K - 2700K
1454	● AG - aluminium grey	3K - 3000K
1455		4K - 4000K

Driver esterno non compreso / Remote driver to be ordered separately (page 59)  
1,5 m di cavo interrabile 2x0,8 / 1,5 m buriable cable 2x0,8

Lamp	W	Lm LED	Real Lm	Optic
LED	3	300	65	1x70°
			126	2x70°
			178	4x70°

**Su richiesta / On request**

Lunghezza cavo 7 m / 7 m cable length (code + **MT7**)

# SQUEEZE

Calpestabile di superficie / Ground surface mounted



## SQUEEZE Ø 180 mm 230V

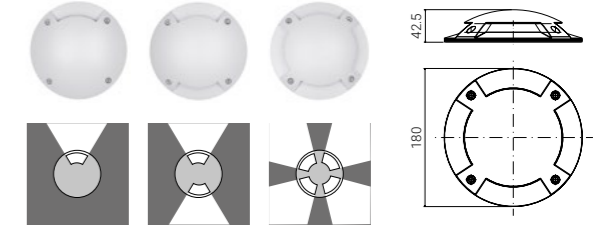

Code		
1467	● AN - anthracite	27K - 2700K
1468	● AG - aluminium grey	3K - 3000K
1469		4K - 4000K

Modulo LED a tensione di rete, compatibile con dimmer a taglio di fase /  
Mains voltage LED module, compatible with most phase-cut dimmers  
1,5 m di cavo interrabile 3x1 H07RN-F / 1,5 m buriable cable 3x1 H07RN-F

Lamp	W	Lm LED	Real Lm	Optic
LED	4	460	94	1x70°
	8 (2x4)	920	188	2x70°
	8 (4x2)	920	188	4x70°

**Su richiesta / On request**

Lunghezza cavo 7 m / 7 m cable length (code + **MT7**)

## SQUEEZE Ø 180 mm 24V

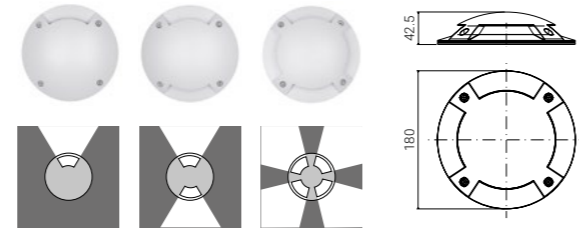

Code		
1457	● AN - anthracite	3K - 3000K
1458	● AG - aluminium grey	4K - 4000K
1459		

Driver esterno non compreso / Remote driver to be ordered separately (page 59)  
1,5 m di cavo interrabile 2x0,8 / 1,5 m buriable cable 2x0,8

Lamp	W	Lm LED	Real Lm	Optic
LED	6,4	640	130	1x70°
	12,8 (2x6,4)	1280	260	2x70°
	12,8 (4x3,2)	1280	215	4x70°

**Su richiesta / On request**

Lunghezza cavo 7 m / 7 m cable length (code + **MT7**)





# SQUEEZE UP

Calpestabile di superficie / Ground surface mounted



## SQUEEZE UP Ø 59 mm 24V

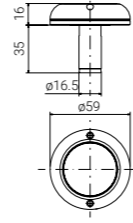

Code	
1451	<ul style="list-style-type: none"> <li><span style="display: inline-block; width: 10px; height: 10px; background-color: black; border-radius: 50%; margin-right: 5px;"></span> AN - anthracite</li> <li><span style="display: inline-block; width: 10px; height: 10px; background-color: grey; border-radius: 50%; margin-right: 5px;"></span> AG - aluminium grey</li> </ul>
	<ul style="list-style-type: none"> <li>3K - 3000K</li> <li>4K - 4000K</li> </ul>

Lamp	W	Lm LED	Real Lm	Optic
LED	3	300	157	diffuse

Driver esterno non compreso / Remote driver to be ordered separately (page 59)  
1,5 m di cavo interrabile 2x0,8 / 1,5 m buriabile cable 2x0,8

**Su richiesta / On request**  
Lunghezza cavo 7 m / 7 m cable length (code + **MT7**)



# SQUEEZE

Accessori / Accessories



## ALIMENTATORI 24V DC / 24V DC CONTROL GEARS

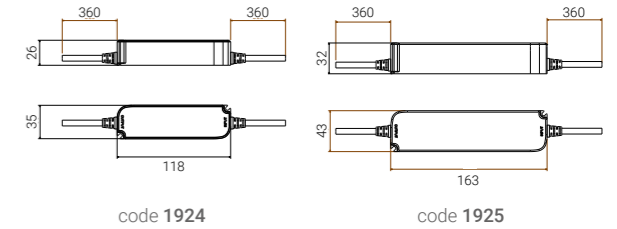

Code	W	Description
1924	24	INPUT 220-240 V - OUTPUT 24V DC
1925	60	

## RAGGRUPPAMENTO SUGGERITO PER SINGOLO ALIMENTATORE REMOTO / SUGGESTED GROUPAGE FOR SINGLE REMOTE CONTROL GEAR

Luminaires			24V remote control gears			
			1924 (24W)		1925 (60W)	
Series	Code	W	min	max	min	max
SQUEEZE Ø 59 mm	1451	3W	1	7	8	18
SQUEEZE Ø 77 mm	1453 - 1454 - 1455	3W	1	7	8	18
SQUEEZE Ø 180 mm	1457	6,4W	1	3	4	8
SQUEEZE Ø 180 mm	1458 - 1459	12,8W	1	1	2	4



LAMPADE  
SEGNAPASSO A  
PARETE E SU PALO

STEPLIGHT FITTINGS  
AND POSTS

# STAMP



La serie STAMP di lampade per esterno amplia il concetto di installazione di superficie e di incasso a parete. La sporgenza minima di 25 o 30 mm offre un'installazione radente senza incasso nella parete.

L'ottica della luce orientata in basso ottimizza la funzione di segnapasso. STAMP è disponibile anche nelle versioni con luce frontale in vetro o laterale sul muro. La lampada dal design essenziale contiene unità LED altamente tecnologiche e di grande resa luminosa. Un distanziale dedicato permette anche l'ingresso / uscita cavi laterale.

La serie si completa con le controcasse accessorio che consentono l'installazione da incasso a filo parete e con i pali STAMP POST di diverse dimensioni, anche in bi-emissione.

The STAMP series of outdoor lamps expands the concept of surface installation and wall recessing. The minimum overhang of 25 or 30 mm offers a grazing installation without recess in the wall.

The optic of the light oriented downwards optimizes the path marker function. STAMP is also available in versions with glass front or side light on the wall. The essential design lamp contains highly technological LED units with great light output. A dedicated spacer also allows for lateral cable entry / exit.

The series is completed with accessory backboxes that allow flush-mounted installation and with STAMP POST poles of different sizes, also in bi-emission.

## STEPLIGHT FITTINGS



STAMP  
110



STAMP  
175



STAMP  
280



STAMP GLASS

## STEPLIGHT FITTINGS AND WALL EFFECTS



STAMP SIDE LIGHT  
one window



STAMP SIDE LIGHT  
two windows



STAMP SIDE LIGHT  
four windows

## POSTS



STAMP POST  
H 300-600



STAMP POST  
H 600-900



STAMP POST GLASS  
H 300-600



# STAMP

## Struttura

Corpo lampada in alluminio primario anticorrosione a basso contenuto di rame. Diffusore in policarbonato anti UV, recesso per una riduzione efficace dell'abbagliamento diretto.

## Structure

Body in low copper content primary aluminium. Diffuser in UV resistant polycarbonate, recessed for an effective reduction of direct glare.

## Sporgenza minima Minimum thickness

25-30 mm

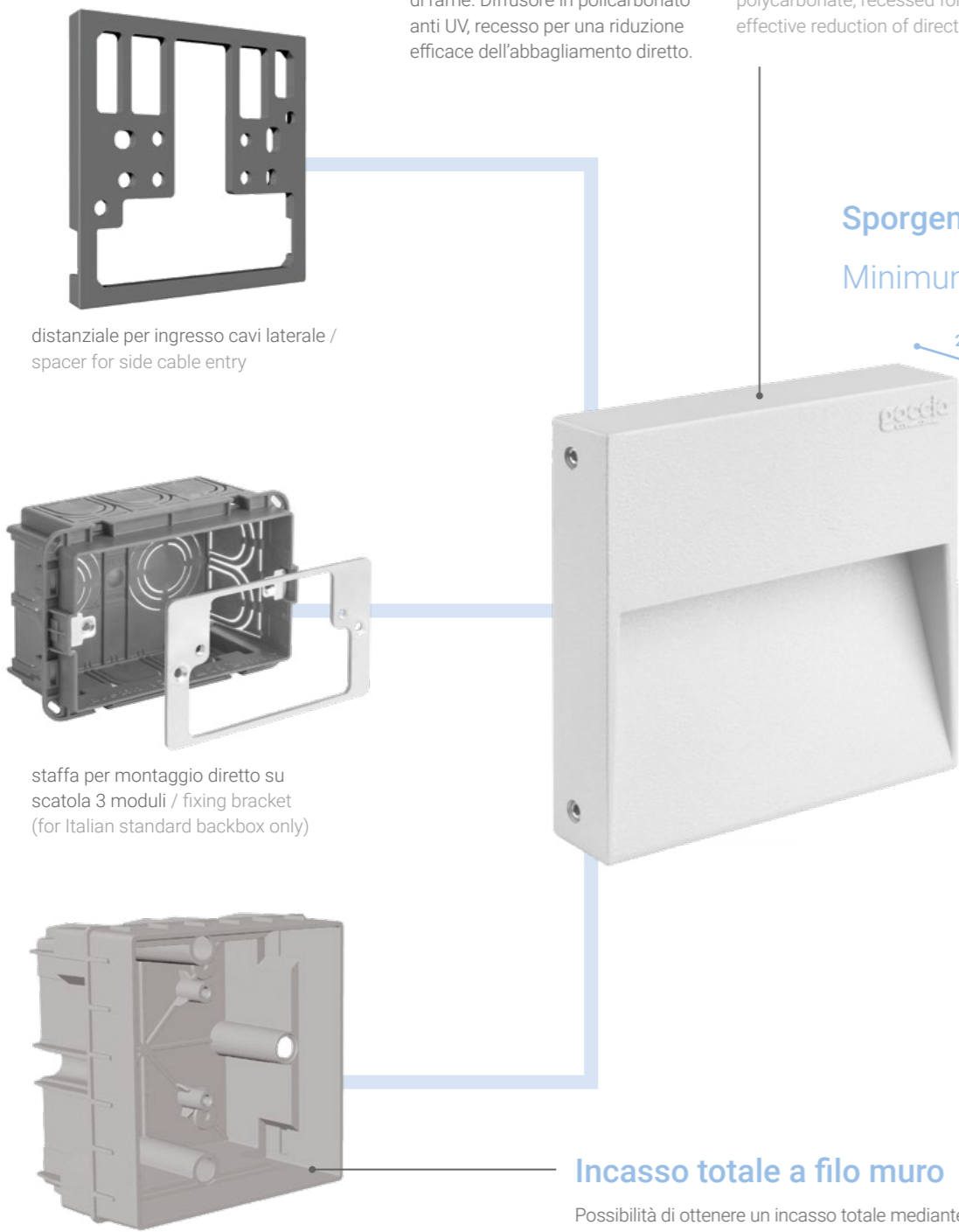

distanziale per ingresso cavi laterale /  
spacer for side cable entry

staffa per montaggio diretto su  
scatola 3 moduli / fixing bracket  
(for Italian standard backbox only)

controcassa per incasso totale /  
backbox for flush recessing

## Incasso totale a filo muro

Possibilità di ottenere un incasso totale mediante le apposite controcasse fornite con coperchio di protezione.

## Wall flush installation

Dedicated backboxes, supplied with protection cover, allow flush recessing.

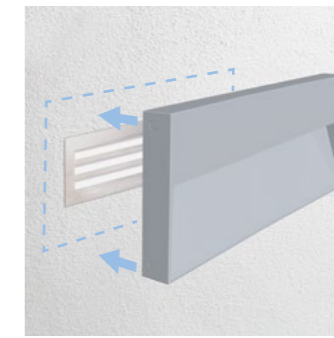
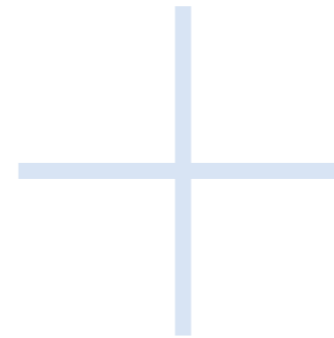

## Montaggio a sormonto

La soluzione a superficie risolve la necessità di coprire vani dovuti a precedenti installazioni.

## Overlap mounting

The surface solution solves any needs of covering holes due to previous installations.

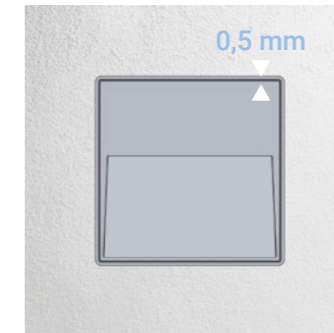

## Fessura minima

La fessura tra lampada e controcassa è limitata a soli 0,5 mm.

## Minimum slot

The space between the backbox and the recessed light fitting is 0,5 mm only.



## Agevole estrazione del corpo lampada

Estrazione semplice del corpo lampada mediante la trazione con le dita sulla palpebra.

## Easy luminaire extraction

Remove the light fitting from the backbox by a simple hand pull.

# STAMP

Lampada segnapasso / Steplight fitting



## STAMP 110

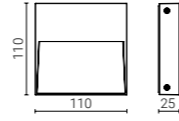

### Code

5321	AN - anthracite	27K - 2700K 3K - 3000K 4K - 4000K
	AG - aluminium grey	
	BI - white	
	CO - corten	

Lamp	W	Lm LED	Real Lm	Optic
LED	4	460	210	asym.

Modulo LED a tensione di rete, compatibile con dimmer a taglio di fase / Mains voltage LED module, compatible with most phase-cut dimmers

### Su richiesta / On request

24V low voltage (code + 24V)

BR - bronze

## STAMP 175-280



code 5323



code 5326

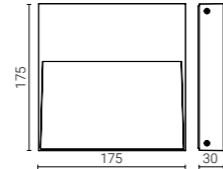

code 5323

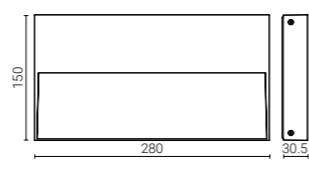

code 5326

### Code

5323	AN - anthracite	27K - 2700K 3K - 3000K 4K - 4000K
	AG - aluminium grey	
5326	BI - white	
	CO - corten	

Lamp	W	Lm LED	Real Lm	Optic
LED	8	1077	520	asym.
	16	2345	936	asym.

5323 Driver dimmerabile a taglio di fase / Phase-cut dimmable driver

### Su richiesta / On request

24÷48V low voltage (code + LV)

Versione dimmerabile / Dimmable version

BR - bronze

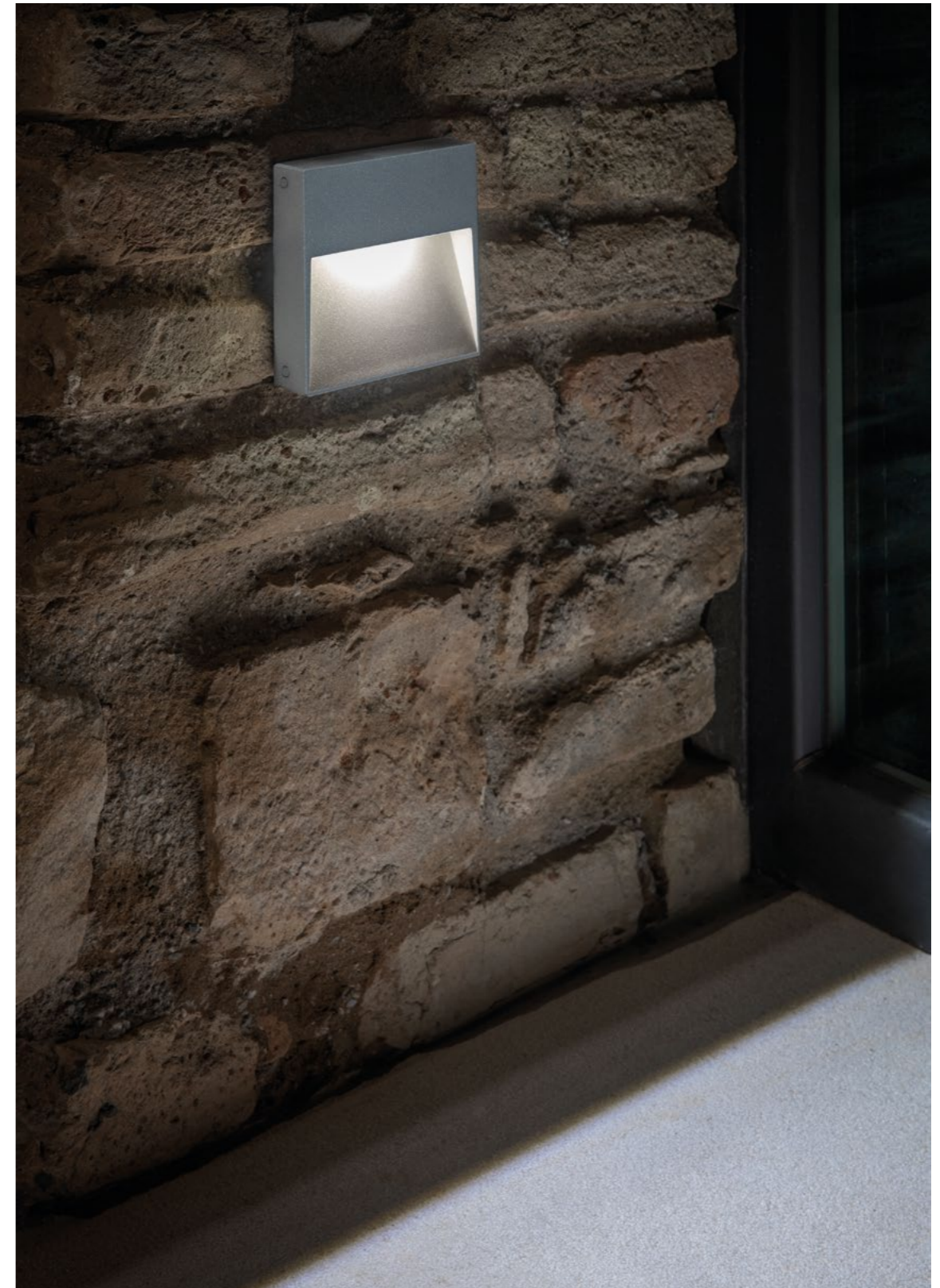



# STAMP

Accessori / Accessories



## DISTANZIALI / SPACERS



code 5351



code 5352

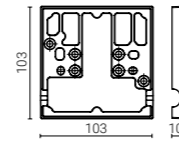

code 5351

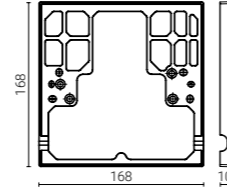

code 5352

Code	Description	Ref. to
5351	Distanziale per ingresso cavi laterale / Spacer for side cable entry	code 5321
5352	Distanziale per ingresso cavi laterale, cablaggio entra/esci consentito / Spacer for side cable entry, through wiring allowed	code 5323

## CONTROCASSE / BACKBOXES



code 5358



code 5359

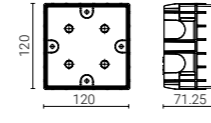

code 5358

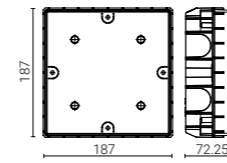

code 5359

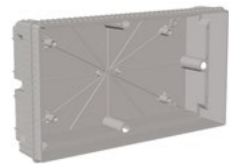

code 5357

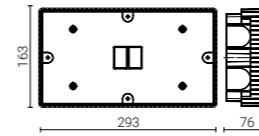

code 5357

Code	Description	Ref. to
5358	Controcassa per incasso totale, completa di coperchio / Backbox for wall flush installation, complete with cover	code 5321
5359		code 5323
5357		code 5326

# STAMP

Accessori / Accessories



## STAFFA PER SCATOLA 3 MOD. / FIXING BRACKET



Code	Description	Ref. to
5360	Staffa per fissaggio a sporgere su cassetta 3 moduli standard / Fixing bracket (for Italian standard backbox only)	code 5321

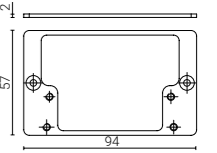

# STAMP POST

Pali / Posts



## PALI / POSTS H 300-600

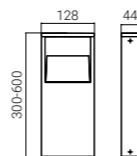

	Code	H	Lamp	W	Lm LED	Real Lm	Optic
5371	● AN - anthracite 27K - 2700K 3K - 3000K	300 mm	LED	4	460	210	asym.
5372	● AG - aluminium grey 4K - 4000K	600 mm					

Pali in alluminio completi di apparecchio e cavo precablato H05RN-F / Posts in aluminium, fitting and H05RN-F pre-wired cable included

Modulo LED a tensione di rete, compatibile con dimmer a taglio di fase / Mains voltage LED module, compatible with most phase-cut dimmers

**Su richiesta / On request**

24V low voltage (code + 24V)

● CO - corten

## PALI / POSTS H 600-900

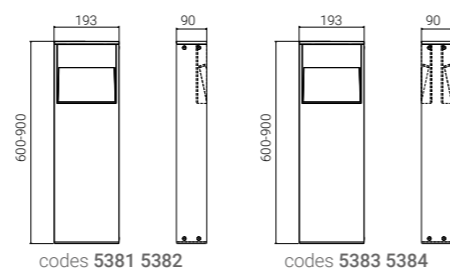

	Code	H	Lamp	W	Lm LED	Real Lm	Optic
5381	● AN - anthracite 27K - 2700K 3K - 3000K	600 mm	LED	8	1077	520	asym.
5382		900 mm					
5383	● AG - aluminium grey 4K - 4000K	600 mm		16 (2x8)	2154	1040	
5384	900 mm						

Pali in alluminio completi di apparecchio e cavo precablato H05RN-F / Posts in aluminium, fitting and H05RN-F pre-wired cable included

Driver dimmerabile a taglio di fase / Phase-cut dimmable driver

**Su richiesta / On request**

24-48V low voltage (code + LV)

Versione dimmerabile / Dimmable version

● CO - corten







# STAMP POST

Accessori / Accessories



## PIASTRE TIRAFONDI / PLATES WITH ANCHORING SET



code 5391



code 5392

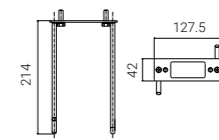

code 5391

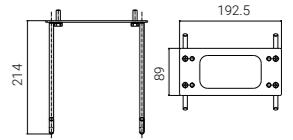

code 5392

Code	Description	Ref. to
5391	Piastra inox con tirafondi per ancoraggio al terreno / Stainless steel plate with ground anchoring set	code 5371 code 5372
5392		code 5381 code 5382 code 5383 code 5384

## GIUNTI STAGNI / WATERPROOF CONNECTIONS



code 1941



code 1944

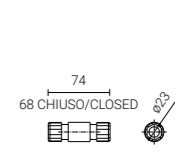

code 1941

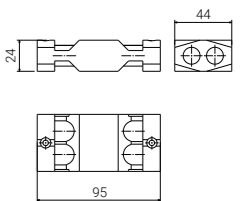

code 1944

Code	Description
1941	Connessione singola 3x2,5 mm <sup>2</sup> IP68 / Single connector 3x2,5 mm <sup>2</sup> IP 68
1944	Connessione fino a 4 uscite 3x2,5 mm <sup>2</sup> IP68 (basato su gel silconico bicomponente) / Up to 4 outputs connector 3x2,5 mm <sup>2</sup> , based on two-component silicone gel

## STAMP VETRO / GLASS

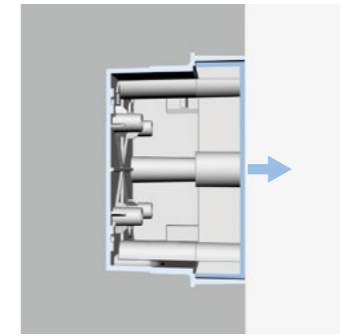
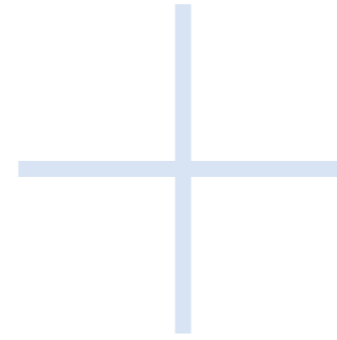

### Incasso totale a filo muro

Le controcasse sono fornite con un robusto coperchio di protezione e permettono di ottenere una reale ed effettiva sporgenza zero.

### Wall flush installation

The backboxes are supplied with a robust protection cover and allow to obtain a real and effective zero protrusion.



### Estrazione con ventosa

Agevole estrazione del corpo lampada con ventosa in dotazione.

### Removable by the sucker

Easy luminaire extraction by the sucker supplied.



### Versione su palo

Disponibile in due altezze; fornita con spezzone di cavo in bassa tensione.

### Post version

Available in two heights; supplied with low voltage cable.

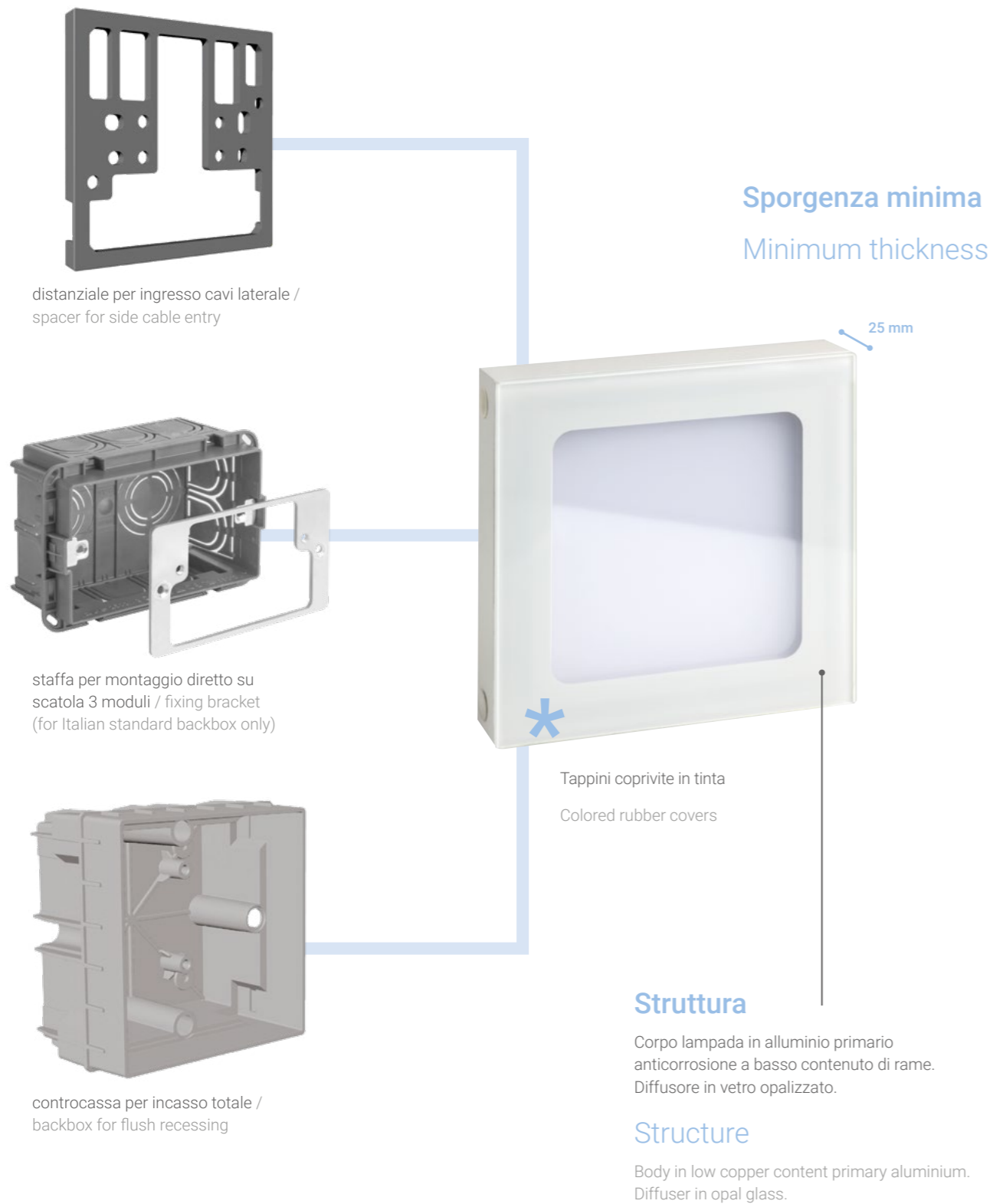



# STAMP VETRO / GLASS

Lampada segnapasso / Steplight fitting



## LAMPADA / LUMINAIRE

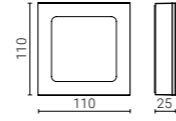

Code	Lamp	W	Lm LED	Real Lm	Optic
5331	● AN - anthracite	6	698	302	diffuse
	● AG - aluminium grey				
	○ BI - white				
			3K - 3000K 4K - 4000K		

Driver esterno non compreso / Remote driver to be ordered separately (page 76)

# STAMP POST VETRO / POST GLASS

Pali / Posts



## PALI / POSTS H 300-600

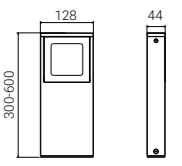

Code	H	Lamp	W	Lm LED	Real Lm	Optic
5374	300 mm	LED	6	698	302	diffuse
5375	600 mm					
				3K - 3000K 4K - 4000K		

Pali in alluminio completi di apparecchio e cavo precablato / Posts in aluminium, fitting and pre-wired cable included

Driver esterno non compreso / Remote driver to be ordered separately (page 76)



## PIASTRA TIRAFONDI / PLATE WITH ANCHORING SET

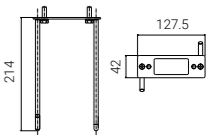

Code	Description
5391	Piastra inox con tirafondi per ancoraggio al terreno / Stainless steel plate with ground anchoring set

# STAMP VETRO / GLASS

Accessori / Accessories



## ALIMENTATORI 24V DC / 24V DC CONTROL GEARS

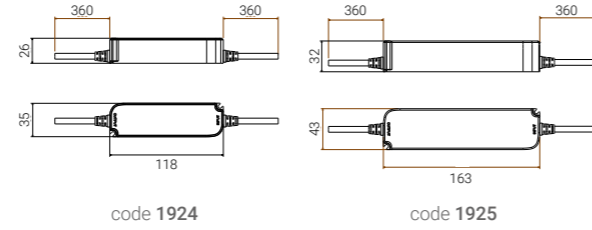

Code	W	Description
1924	24	INPUT 220-240 V - OUTPUT 24V DC
1925	60	

1924 controlla da 1 a 3 apparecchi STAMP VETRO / controls from 1 to 3 luminaires STAMP GLASS

1925 controlla da 4 a 9 apparecchi STAMP VETRO / controls from 4 to 9 luminaires STAMP GLASS

## DISTANZIALE / SPACER

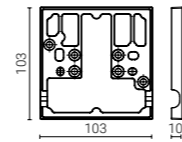

Code	Description
5351	Distanziale per ingresso cavi laterale / Spacer for side cable entry

# STAMP VETRO / GLASS

Accessori / Accessories



## CONTROCASSA / BACKBOX

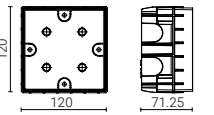

Code	Description
5358	Controcassa per incasso totale, completa di coperchio / Backbox for wall flush installation, complete with cover

## STAFFA PER SCATOLA 3 MOD. / FIXING BRACKET

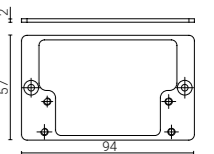

Code	Description
5360	Staffa per fissaggio a sporgere su cassetta 3 moduli standard / Fixing bracket (for Italian standard backbox only)



## STAMP LUCE LATERALE / SIDE LIGHT

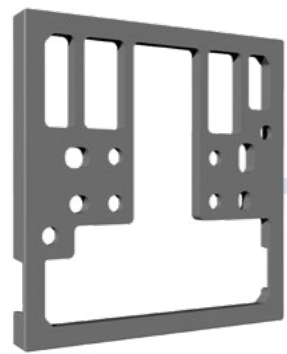
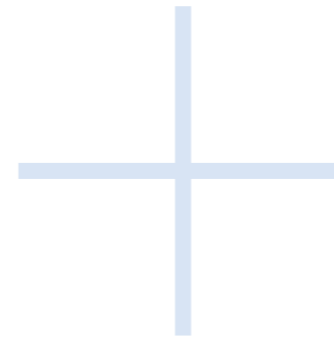

distanziale per ingresso cavi laterale /  
spacer for side cable entry

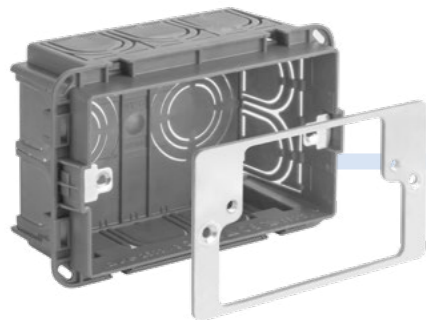

staffa per montaggio diretto su  
scatola 3 moduli / fixing bracket  
(for Italian standard backbox only)



1, 2 o 4 finestre  
1, 2 or 4 windows

### Struttura

Corpo lampada in alluminio primario anticorrosione a basso contenuto di rame.  
Diffusori in policarbonato anti UV.

### Structure

Body in low copper content primary aluminium.  
Diffusers in UV resistant polycarbonate.



### Sporgenza minima

L'accurato design e la scelta della componentistica permettono uno spessore contenuto di soli 25,5 mm per tutti le versioni.

### Minimum thickness

The accurate design and the choice of components enable to obtain a 25,5 mm minimum protrusion for all versions.



### Tappini coprivite in tinta

Colored rubber covers

# STAMP LUCE LATERALE / SIDE LIGHT

Segnapasso e effetti a parete / Steplight fitting and wall effects

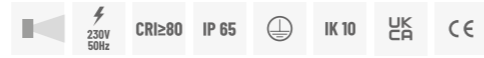

## LAMPADE / LUMINAIRES



code 5335 1 light



code 5336 2 lights



code 5337 4 lights

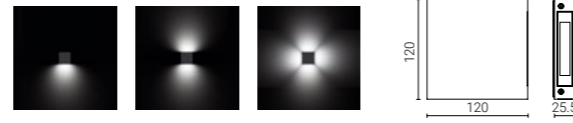

### Code

5335	● AN - anthracite	27K - 2700K
5336	● AG - aluminium grey	3K - 3000K
5337	○ BI - white	4K - 4000K

Modulo LED a tensione di rete, compatibile con dimmer a taglio di fase / Mains voltage LED module, compatible with most phase-cut dimmers

### Lamp W Lm LED Real Lm Optic

LED	4	460	250	diffuse
	8 (2x4)	920	500	
	8 (4x2)	920	500	

Su richiesta / On request

24V low voltage (code + 24V)

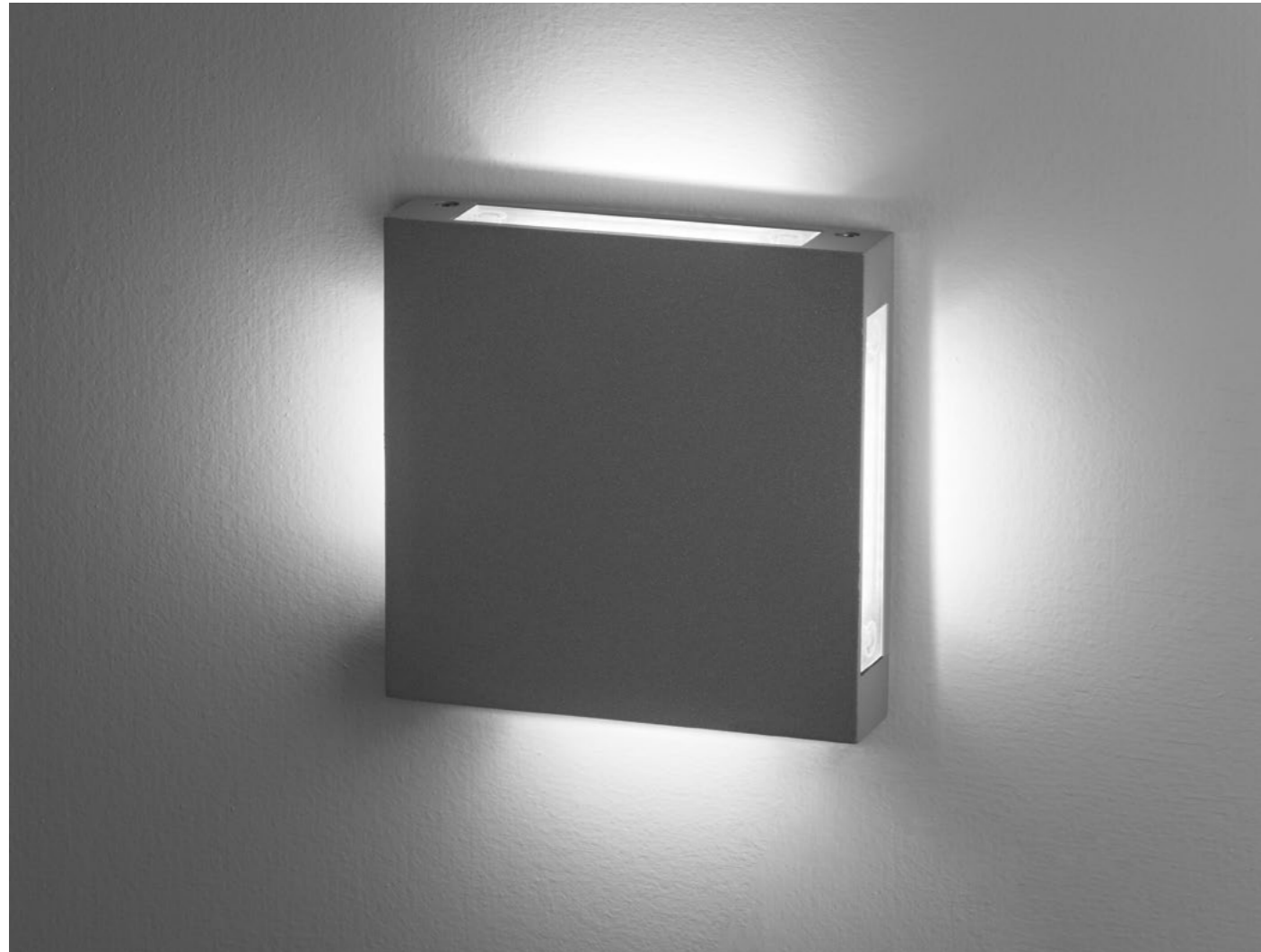

# STAMP LUCE LATERALE / SIDE LIGHT

Accessori / Accessories



## DISTANZIALE / SPACER

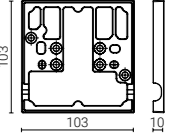

### Code

5351	Distanziale per ingresso cavi laterale / Spacer for side cable entry
------	--

### Description

## STAFFA PER SCATOLA 3 MOD. / FIXING BRACKET

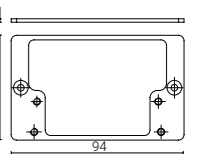

### Code

5360	Staffa per fissaggio a sporgere su cassetta 3 moduli standard / Fixing bracket (for Italian standard backbox only)
------	--

### Description



# QUANTUM



La serie di apparecchi da incasso a tenuta stagna QUANTUM è stata progettata fin dall'origine appositamente per l'applicazione LED. La concezione innovativa del sistema ha consentito di inserire in un corpo di dimensioni ridotte il generoso dissipatore, con trasformatore che consente di collegare QUANTUM alla normale linea 230V. Il sistema modulare di QUANTUM permette di rivestire il corpo lampada con maschere di diverso disegno e materiali. L'aggancio a scatto assicurato da due viti esagonali facilita l'installazione. Le lampade si installano sia nelle comuni scatole per interni da 3, 4 o 6 moduli che nelle speciali controcasse dedicate Goccia Illuminazione per l'uso esterno. La serie si completa con i pali QUANTUM POST per illuminare percorsi pedonali, piste ciclabili, parchi e giardini.

The QUANTUM series of waterproof recessed luminaires was designed from the outset specifically for LED application. The innovative concept of the system has made it possible to insert the generous heat sink in a small body, with a transformer that allows QUANTUM to be connected to the normal 230V line. The QUANTUM modular system allows the lamp body to be covered with masks of different designs and materials. The snap coupling secured by two hex screws facilitates installation. The lamps are installed for outdoor use in the Goccia Illuminazione dedicated backboxes. The series is completed with QUANTUM POST to illuminate pedestrian paths, cycle paths, parks and gardens.

## WALL RECESSED



QUANTUM  
4 mod.



QUANTUM  
3 mod.



QUANTUM  
4 mod.



QUANTUM  
6 mod.



QUANTUM  
6 mod.

## POSTS



QUANTUM POST  
H 580-825



# QUANTUM

## Massima componibilità

La Serie QUANTUM, totalmente componibile, è composta da:

- **controcasse** 503 / 504 / 506 di mercato o specifiche Goccia Illuminazione
- **corpi in policarbonato** a 3 / 4 / 6 moduli standard
- **maschere intercambiabili** in alluminio, policarbonato, INOX AISI 316L o vetro opale

## Maximum modularity

The lighting fittings of the range are supplied in 3 separate parts:

- recessing Goccia Illuminazione **backboxes**, horizontal and vertical
- **polycarbonate lamp bodies** in different wattages and dimensions
- **covering masks** in polycarbonate, aluminium, AISI 316L stainless steel or glass

Incastro snapping della maschera sul corpo con ritenzione di sicurezza mediante viti a brugola inox in tinta.

Mask snap connection on body with safety retention with stainless steel matching Allen key screws.



## Dimensioni ridotte

Goccia Illuminazione ha inserito in un **corpo di dimensioni ridotte** un LED ad alta efficienza e un trasformatore con un potente dissipatore.

## Small dimensions

Goccia Illuminazione has inserted a high efficiency LED and a transformer with a powerful heat sink inside a **compact body**.

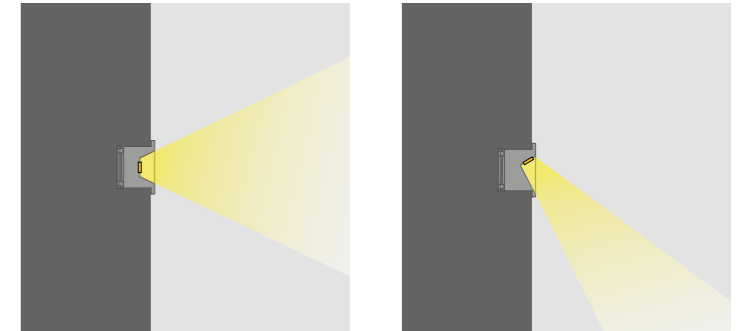
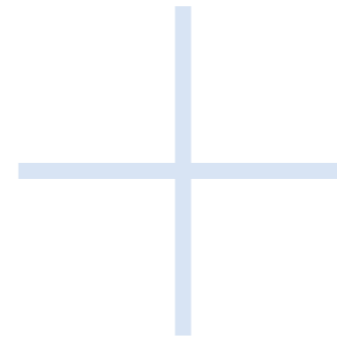

## La giusta luce

Le particolari forme degli apparecchi permettono di **distribuire la luce verso il basso o frontalmente** offrendo un'ampia gamma illuminotecnica.

## The right light

The particular shapes of the fittings allow you to **distribute light downwards or frontally**, offering a wide lighting range.





# QUANTUM

Incasso a parete a tenuta stagna / Watertight wall recessed



## CORPO LAMPADA / LIGHT BODY 4 mod.

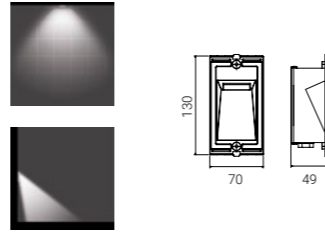

Code	
5425	3K - 3000K 4K - 4000K

Installabile su scatola 4 mod. o cod. 5481 /  
To be installed on the backbox code 5481 (page 91)

Lamp	W	Lm LED	Real Lm	Optic
LED	4,5	265	168	asym.

Su richiesta / On request  
24V low voltage (code + 24V)

# QUANTUM

Incasso a parete a tenuta stagna / Watertight wall recessed



## CORPO LAMPADA / LIGHT BODY 3 mod.

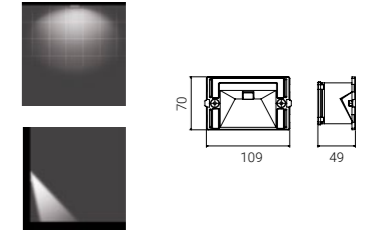

Code	
5420	27K - 2700K 3K - 3000K 4K - 4000K

Installabile su scatola 3 mod. o cod. 5480 /  
To be installed on the backbox code 5480 (page 91)

Lamp	W	Lm LED	Real Lm	Optic
LED	2	212	115	asym.

Su richiesta / On request  
10=52V low voltage (code + LV)

## MASCHERE / MASKS 4 mod.



code 5452 AN



code 5462

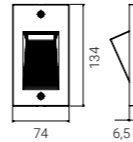

code 5452 5462



code 5472 IN



code 5441 OP

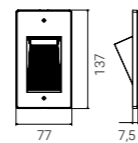

code 5472

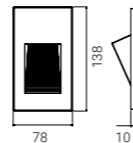

code 5441

Code	Description
5452	● AN - anthracite
5462	● AN - anthracite
	● AG - aluminium grey
	○ BI - white
5472	● IN - stainless steel
5441	● OP - opal white

Description
Maschera di rivestimento in policarbonato / Covering mask in polycarbonate
Maschera di rivestimento in alluminio pressofuso / Covering mask in die-cast aluminium
Maschera di rivestimento in acciaio inox AISI 316L / Covering mask in AISI 316L st. steel
Maschera di rivestimento in vetro piano temprato / Covering mask in flat tempered glass

## MASCHERE / MASKS 3 mod.



code 5460



code 5442 OP

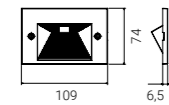

code 5460

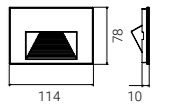

code 5442

Code	Description
5460	● AN - anthracite ● AG - aluminium grey ○ BI - white
5442	● OP - opal white

Description
Maschera di rivestimento in alluminio pressofuso / Covering mask in die-cast aluminium
Maschera di rivestimento in vetro piano temprato / Covering mask in flat tempered glass

# QUANTUM

Incasso a parete a tenuta stagna / Watertight wall recessed



## CORPO LAMPADA / LIGHT BODY 4 mod.

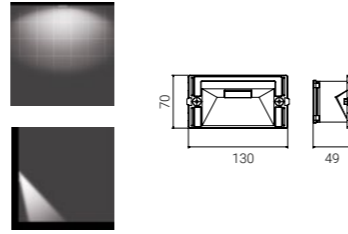

Code	
5430	3K - 3000K 4K - 4000K

Installabile su scatola 4 mod. o cod. 5481 /  
To be installed on the backbox code 5481 (page 91)

Lamp	W	Lm LED	Real Lm	Optic
LED	4,5	265	168	asym.

Su richiesta / On request  
10=52V low voltage (code + LV)

## MASCHERE / MASKS 4 mod.

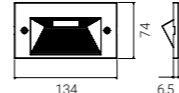

code 5453 AN

code 5463

code 5453 5463

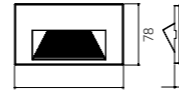
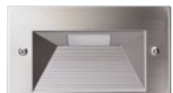

code 5473 IN

code 5443 OP

code 5473

code 5443

Code	Description
5453	Maschera di rivestimento in policarbonato / Covering mask in polycarbonate
5463	Maschera di rivestimento in alluminio pressofuso / Covering mask in die-cast aluminium
5473	Maschera di rivestimento in acciaio inox AISI 316L / Covering mask in AISI 316L st. steel
5443	Maschera di rivestimento in vetro piano temprato / Covering mask in flat tempered glass

# QUANTUM

Incasso a parete a tenuta stagna / Watertight wall recessed



## CORPO LAMPADA / LIGHT BODY 6 mod.

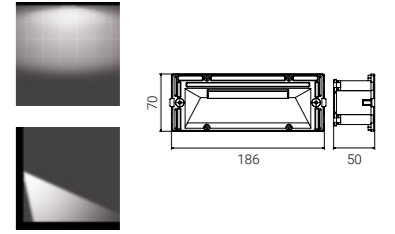

Code	
5435	3K - 3000K 4K - 4000K

Installabile su scatola 6 mod. o cod. 5482 /  
To be installed on the backbox code 5482 (page 91)

Lamp	W	Lm LED	Real Lm	Optic
LED	4,5	460	273	asym.

Su richiesta / On request  
10=52V low voltage (code + LV)

## MASCHERE / MASKS 6 mod.

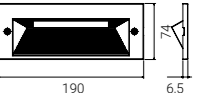

code 5454 AN

code 5464

code 5454 5464



code 5474 IN

code 5444 OP

code 5474

code 5444

Code	Description
5454	Maschera di rivestimento in policarbonato / Covering mask in polycarbonate
5464	Maschera di rivestimento in alluminio pressofuso / Covering mask in die-cast aluminium
5474	Maschera di rivestimento in acciaio inox AISI 316L / Covering mask in AISI 316L st. steel
5444	Maschera di rivestimento in vetro piano temprato / Covering mask in flat tempered glass



# QUANTUM

Incasso a parete a tenuta stagna / Watertight wall recessed



## CORPO LAMPADA / LIGHT BODY 6 mod.

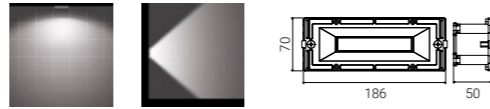

Code	
5440	3K - 3000K 4K - 4000K

Installabile su scatola 6 mod. o cod. 5482 /  
To be installed on the backbox code 5482 (page 91)

Lamp	W	Lm LED	Real Lm	Optic
LED	4,5	460	325	diffuse

Su richiesta / On request  
10=52V low voltage (code + LV)

## MASCHERE / MASKS 6 mod.



code 5455 AN      code 5465



code 5466      code 5467

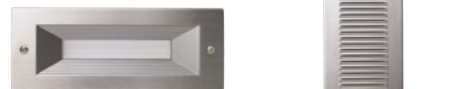

code 5475 IN      code 5476 IN



code 5477 IN

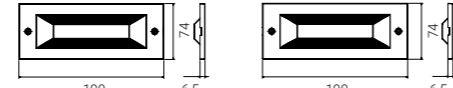

code 5455

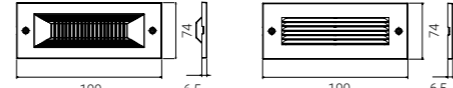

code 5466

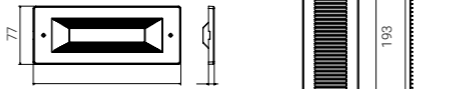

code 5475

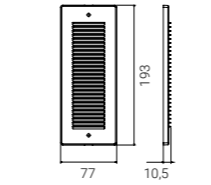

code 5476

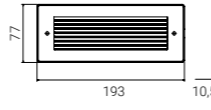

code 5477

Code	
5455	● AN - anthracite
5465	● AN - anthracite
5466	● AG - aluminium grey
5467	○ BI - white
5475	
5476	● IN - stainless steel
5477	

Description
Maschera di rivestimento in policarbonato / Covering mask in polycarbonate
Maschera di rivestimento in alluminio pressofuso / Covering mask in die-cast aluminium
Maschera di rivestimento in acciaio inox AISI 316L / Covering mask in AISI 316L st. steel

# QUANTUM

Accessori / Accessories



## CONTROCASSE / BACKBOXES

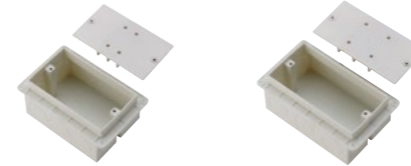

code 5480      code 5481



code 5482

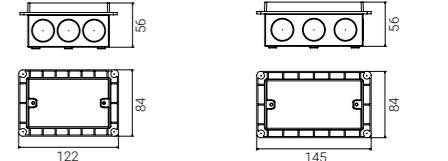

code 5480      code 5481

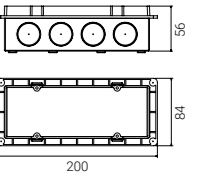

code 5482

Code	Description	Ref. to
5480	Controcassa 3 mod., completa di coperchio / Backbox 3 mod., cover included	code 5420
5481	Controcassa 4 mod., completa di coperchio / Backbox 4 mod., cover included	code 5425 code 5430
5482	Controcassa 6 mod., completa di coperchio / Backbox 6 mod., cover included	code 5435 code 5440

# QUANTUM POST

Pali da giardino / Garden posts



## PALI / POSTS H 580-825

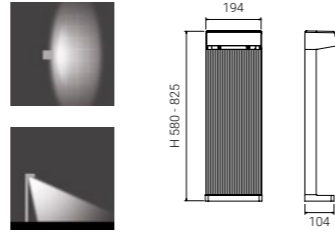

	Code	H	Lamp	W	Lm LED	Real Lm	Optic
5594	● AN - anthracite 27K - 2700K 3K - 3000K	580 mm	LED	13	1500	1123	diffuse
5593	● AG - aluminium grey 4K - 4000K	825 mm					

Palo in alluminio + piastra inox reggi-tirafondi incorporata (tirafondi forniti separatamente) / Post in aluminium + stainless steel plate incorporated (anchoring set supplied separately)

**Su richiesta / On request**  
Versione dimmerabile / Dimmable version

## TIRAFONDI / ANCHORING SET

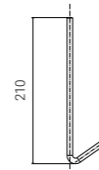

Code	Description
5529	4 tirafondi inox per ancoraggio al terreno / 4 stainless steel ground anchors

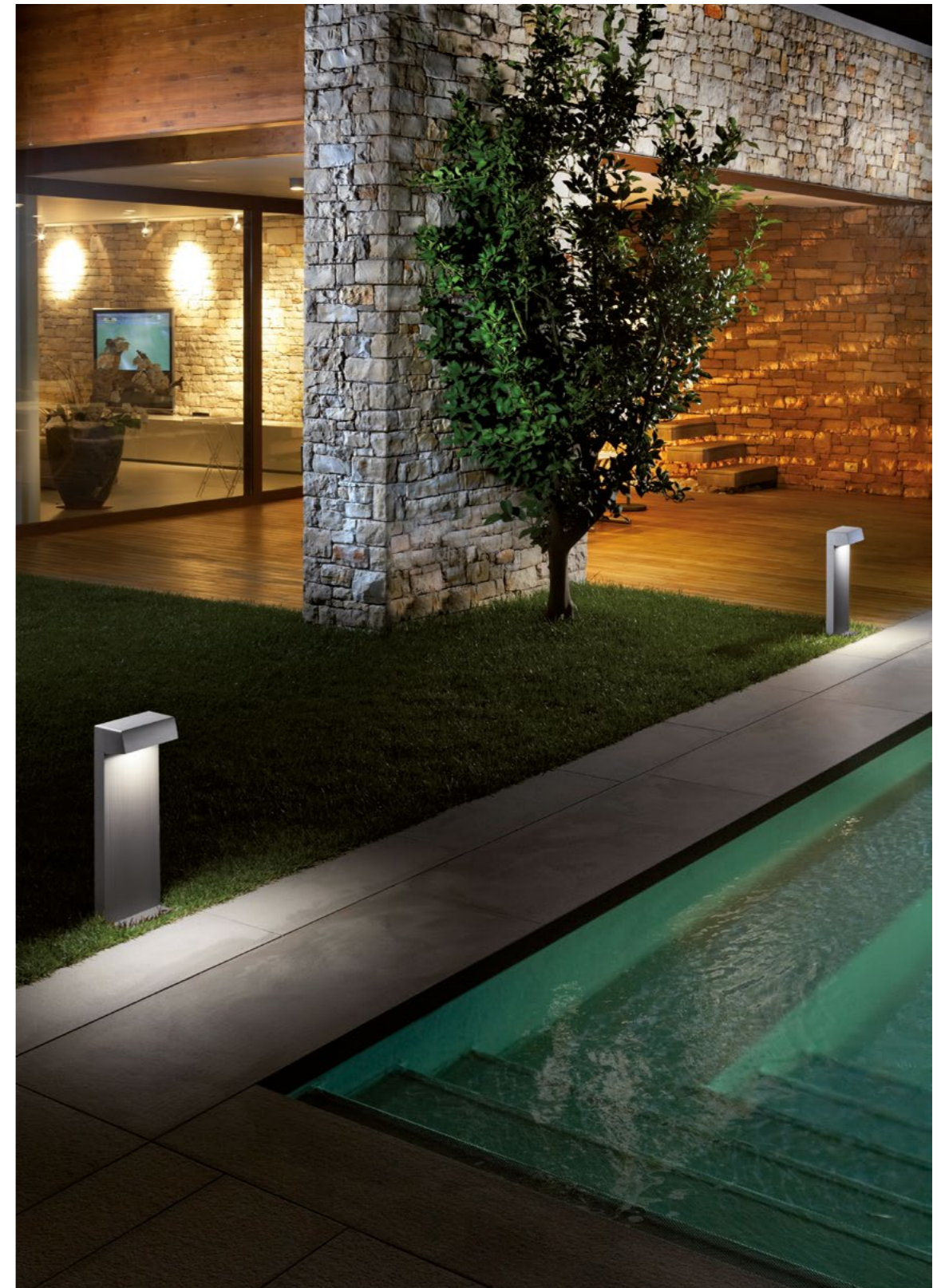



## CLOCK



Un piccolo proiettore circolare dal design essenziale e di carattere, CLOCK è uno spotlight versatile e preciso. Spessore contenuto ed elegante orientabilità, con le sue due dimensioni offre grande qualità illuminotecnica, grazie ai performanti LED ed alle ottiche accuratamente studiate per permettere svariate modalità di impiego del flusso luminoso.

Gli accessori a corredo incrementano le tipologie di installazione ed il comfort visivo di CLOCK con stile - soluzioni puntuali per un'illuminazione d'accento scenografico e vibrante.

A small circular projector with an essential design and character, CLOCK is a versatile and precise spotlight. Low thickness and elegant adjustability, with its two dimensions it offers great lighting quality, thanks to the high-performance LEDs and specific designed optics to allow various ways of using the luminous flux.

The accessories supplied increase the types of installation and the visual comfort of CLOCK with style - punctual solutions for scenographic and vibrant accent lighting.

## SPOTLIGHT

CLOCK  
Ø 80CLOCK  
Ø 120

# CLOCK

## Spessore ridotto

Lo spessore di soli 36 mm per i due diametri consente un inserimento non invasivo negli ambienti esterni.

## Reduced thickness

Its 36 mm thickness for both diameters allows to fix CLOCK discreetly in outdoor settings.

Il corpo in alluminio ruota intorno al perno di fissaggio per facilitare l'orientamento sul piano verticale. Il blocco è garantito da una vite 8MA. Due asole sulla base consentono l'orientamento orizzontale  $\pm 40^\circ$ .

The aluminium body rotates around the locking pin on the vertical surface to easily adjust its direction. An 8MA screw locks it in place. Two eyelets on the base allow for a  $\pm 40^\circ$  horizontal adjustment.



## Cablaggio stagno

CLOCK è ermeticamente chiuso con resina bicomponente e fornito con 1,5 m di cavo interrabile H05RN-F. Il cavo può passare nell'apposito foro della basetta del braccio.

- Pressacavo in ottone
- Resinatura Acquastop
- Cavo antistrappo

## Watertight wiring

CLOCK is hermetically sealed with a two-component resin and provided with an 1,5 m H05RN-F cable. The cable can pass through a special hole in the base of the arm.

- Brass cable gland
- Aquastop Resin Finish
- Anti-tear cable

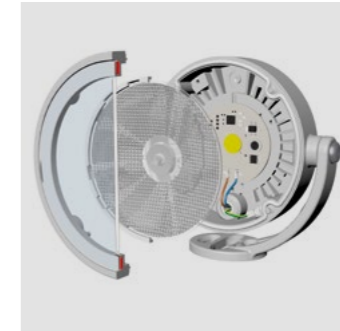
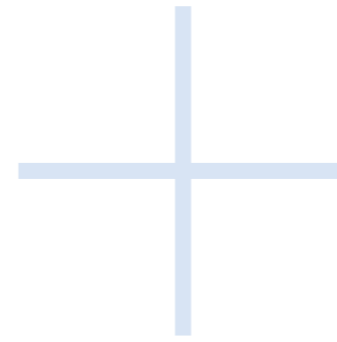

## Vetro sigillato

Il vetro frontale temprato trasparente ultrawhite è sigillato alla cornice di chiusura per consentire la massima tenuta.

## Sealed glass

The front tempered ultrawhite clear glass is sealed to the frame for a perfect watertight.

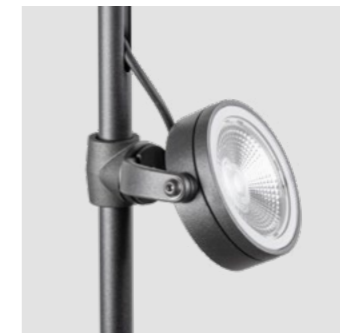

## Steli

Steli predisposti per passaggio cavi grazie ad apposite asole.

## Stems

Stems suitable for cable entry thanks to dedicated slots.





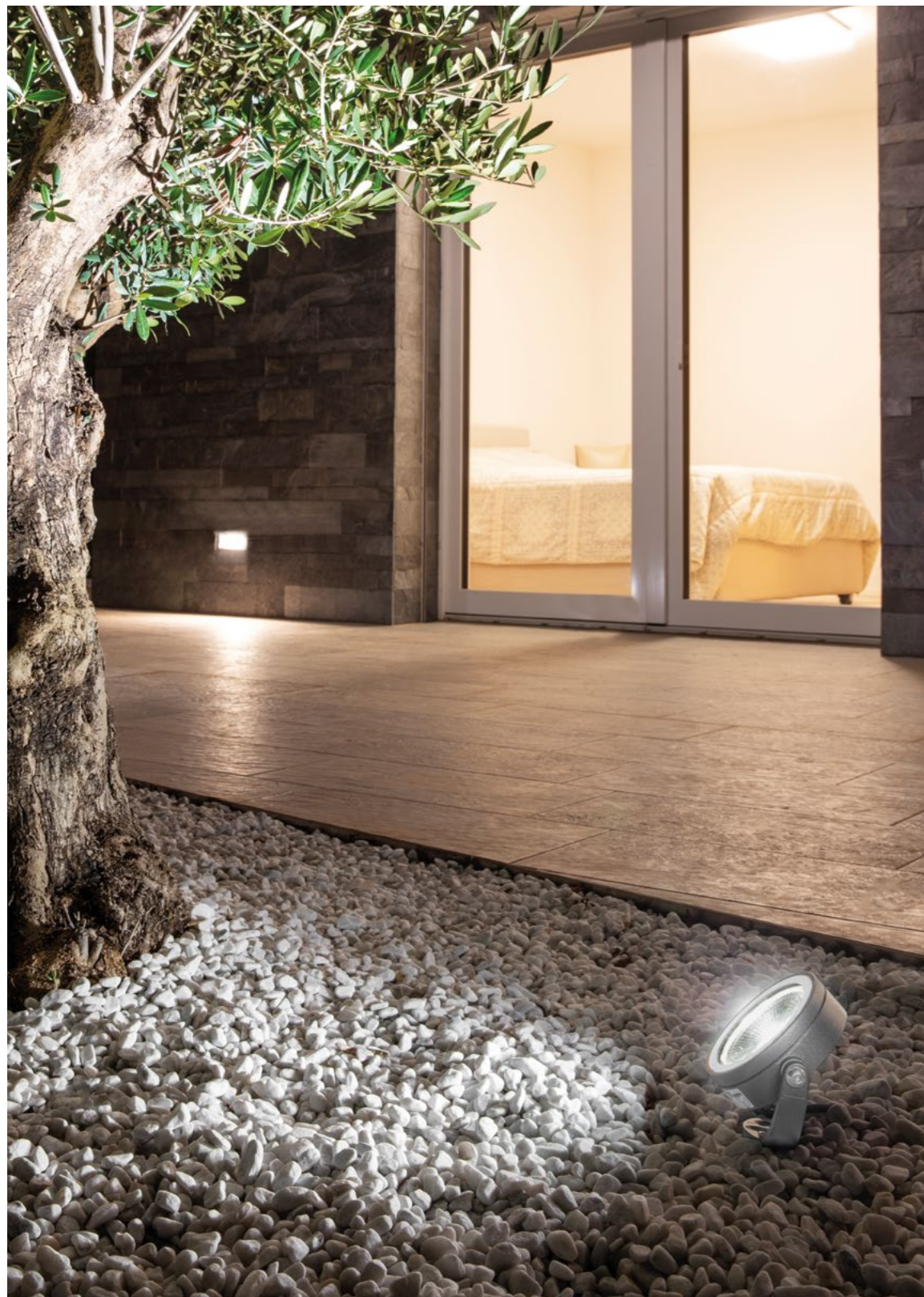

# CLOCK

Spot / Spotlight



## CLOCK Ø 80 mm

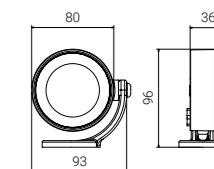

	Code	
4661	AN - anthracite	27K - 2700K
	AG - aluminium grey	3K - 3000K
	VE - green	4K - 4000K

Lamp	W	Lm LED	Real Lm	Optic
LED	4	460	290	40°

Ottiche opzionali / Optional optics 12° (code + 12), 90° (code + 90)  
 Fornita con 1,5 m di cavo interrabile / 1,5 m buriabile cable included  
 Modulo LED a tensione di rete, compatibile con dimmer a taglio di fase /  
 Mains voltage LED module, compatible with most phase-cut dimmers  
 Versione RGBW (vedi capitolo dedicato) / RGBW version (see related chapter)

**Su richiesta / On request**  
 24V low voltage, cable L 20 cm (code + 24V)  
 Lunghezza cavo 7 m / 7 m cable length (code + MT7)  
 BI - white  CO - corten  BR - bronze

## CLOCK Ø 120 mm

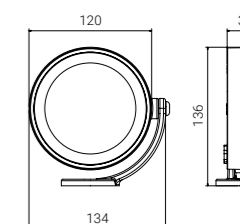

	Code	
4664	AN - anthracite	27K - 2700K
	AG - aluminium grey	3K - 3000K
4665	VE - green	4K - 4000K

Lamp	W	Lm LED	Real Lm	Optic
LED	10	1100	750	40°
	15	1575	1050	

Ottiche opzionali / Optional optics 12° (code + 12), 90° (code + 90)  
 Fornite con 1,5 m di cavo interrabile / 1,5 m buriabile cable included  
 Modulo LED a tensione di rete, compatibile con dimmer a taglio di fase /  
 Mains voltage LED module, compatible with most phase-cut dimmers  
 Versione RGBW (vedi capitolo dedicato) / RGBW version (see related chapter)

**Su richiesta / On request**  
 24V low voltage, cable L 20 cm (code + 24V)  
 Lunghezza cavo 7 m / 7 m cable length (code + MT7)  
 Ottica a nido d'ape / Honeycomb optic 10° (code + HC)  
 BI - white  CO - corten  BR - bronze

# CLOCK

Accessori / Accessories

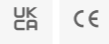

## VISIERA / SHIELD

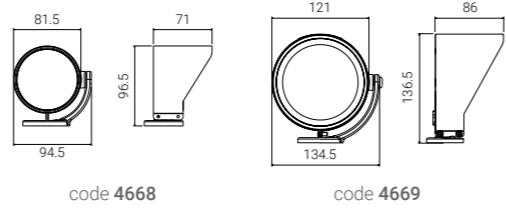

Code	Description	Ref. to
4668	Visiera in acciaio inox verniciato / Shield in painted stainless steel	code 4661
4669		code 4664
		code 4665

## GIUNTI STAGNI / WATERPROOF CONNECTIONS

IP 68



code 1941



code 1942



code 1941



code 1942

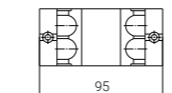
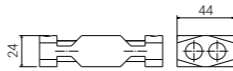
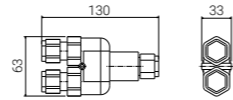

code 1944

Code	Description
1941	Connessione singola 3x2,5 mm <sup>2</sup> IP68 / Single connector 3x2,5 mm <sup>2</sup> IP 68
1942	Connessione entra-esce 3x2,5 mm <sup>2</sup> IP68 / Through wiring connector 3x2,5 mm <sup>2</sup> IP 68
1944	Connessione fino a 4 uscite 3x2,5 mm <sup>2</sup> IP68 (basato su gel siliconico bicomponente) / Up to 4 outputs connector 3x2,5 mm <sup>2</sup> IP 68, based on two-component silicone gel

# CLOCK

Accessori / Accessories



## PICCHETTO / SPIKE



Code	Description	Ref. to
4691	Picchetto da giardino in polycarbonato / Garden spike in polycarbonate	code 4661
		code 4664
		code 4665

Altezza da terra consigliata: 10 cm come da normativa / Recommended height above ground: 10 cm in compliance with regulations

Il cavo può passare nell'apposito foro della basetta e nella struttura del picchetto / The cable can pass through a special hole in the base and through the structure of the spike

## BRACCIO A MURO / WALL ARM

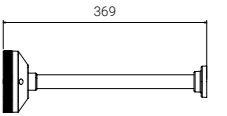

Code	Description	Ref. to
4692	Braccio in alluminio / Aluminium arm	code 4661
		code 4664
		code 4665

Cablaggio interno alla basetta; cablaggio esterno per versioni RGBW / Internal terminal block; external wiring for RGBW versions

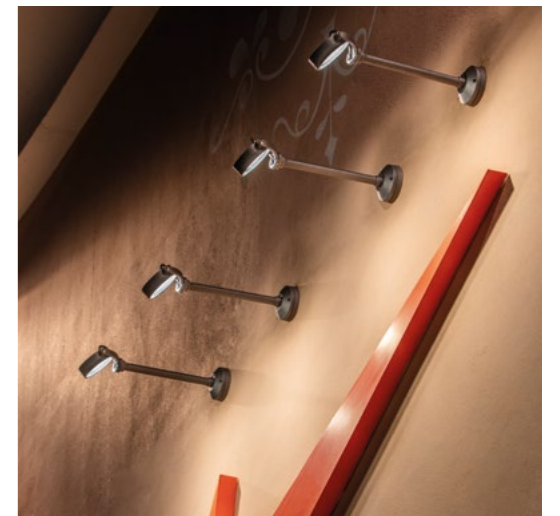







# CLOCK

Accessori / Accessories

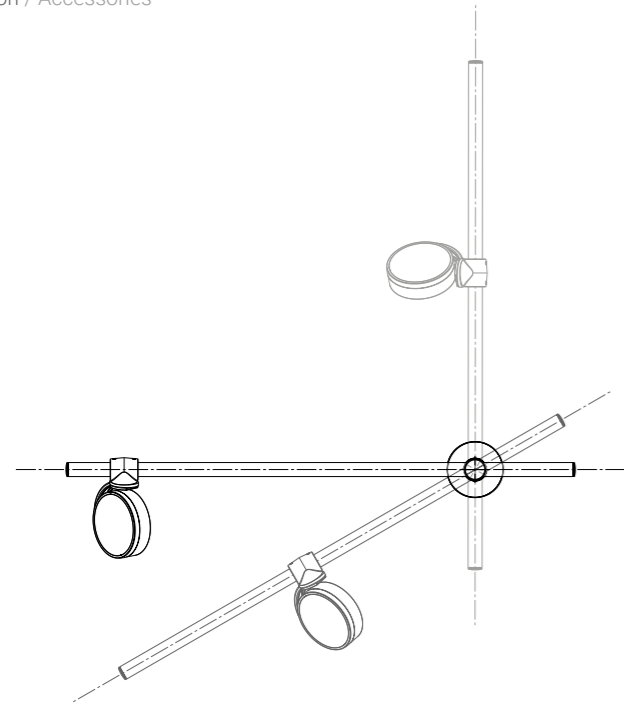

La combinazione di supporto a muro, steli, raccordi e apparecchi CLOCK consente molteplici soluzioni applicative anche con un unico punto luce disponibile.

The combination of wall support, stems, joints and CLOCK luminaires allows multiple applications even with a single light point available.

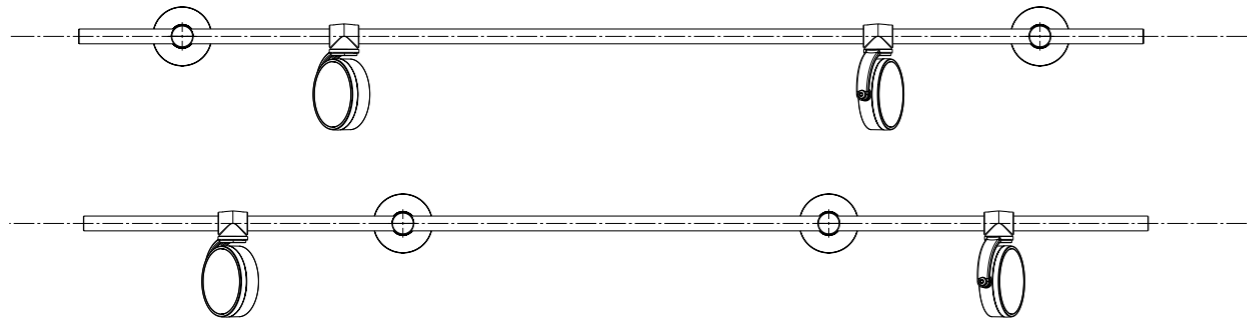

# CLOCK

Accessori / Accessories



## STELI A MURO / WALL STEMS



code 4681



code 4695

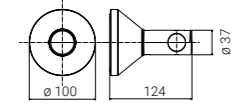

code 4681

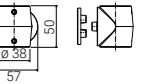

code 4695



code 4682

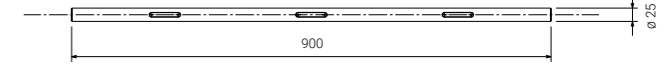

code 4682



code 4683

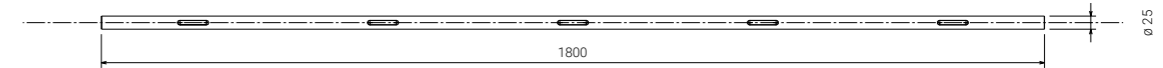

code 4683

Code	Description
4695	Raccordo scorrevole in alluminio pressofuso con relativa piastrina di fissaggio / Adjustable joint in die-cast aluminium with related fixing plate
4682	Stelo a muro L 900 mm (3 asole) in alluminio estruso / Wall stem L 900 mm (3 slots) in extruded aluminium
4683	Stelo a muro L 1800 mm (5 asole) in alluminio estruso / Wall stem L 1800 mm (5 slots) in extruded aluminium
4681	Supporto a muro in alluminio pressofuso / Wall support in die-cast aluminium

4682, 4683 Max 2 cavi all'interno dello stelo a muro /  
Max. 2 cables inside the wall stem

4681 Cablaggio interno alla basetta; cablaggio esterno per versioni RGBW /  
Internal terminal block; external wiring for RGBW versions



# CLOCK

Accessori / Accessories



# CLOCK

Accessori / Accessories

UK CE

## STELI / STEMS

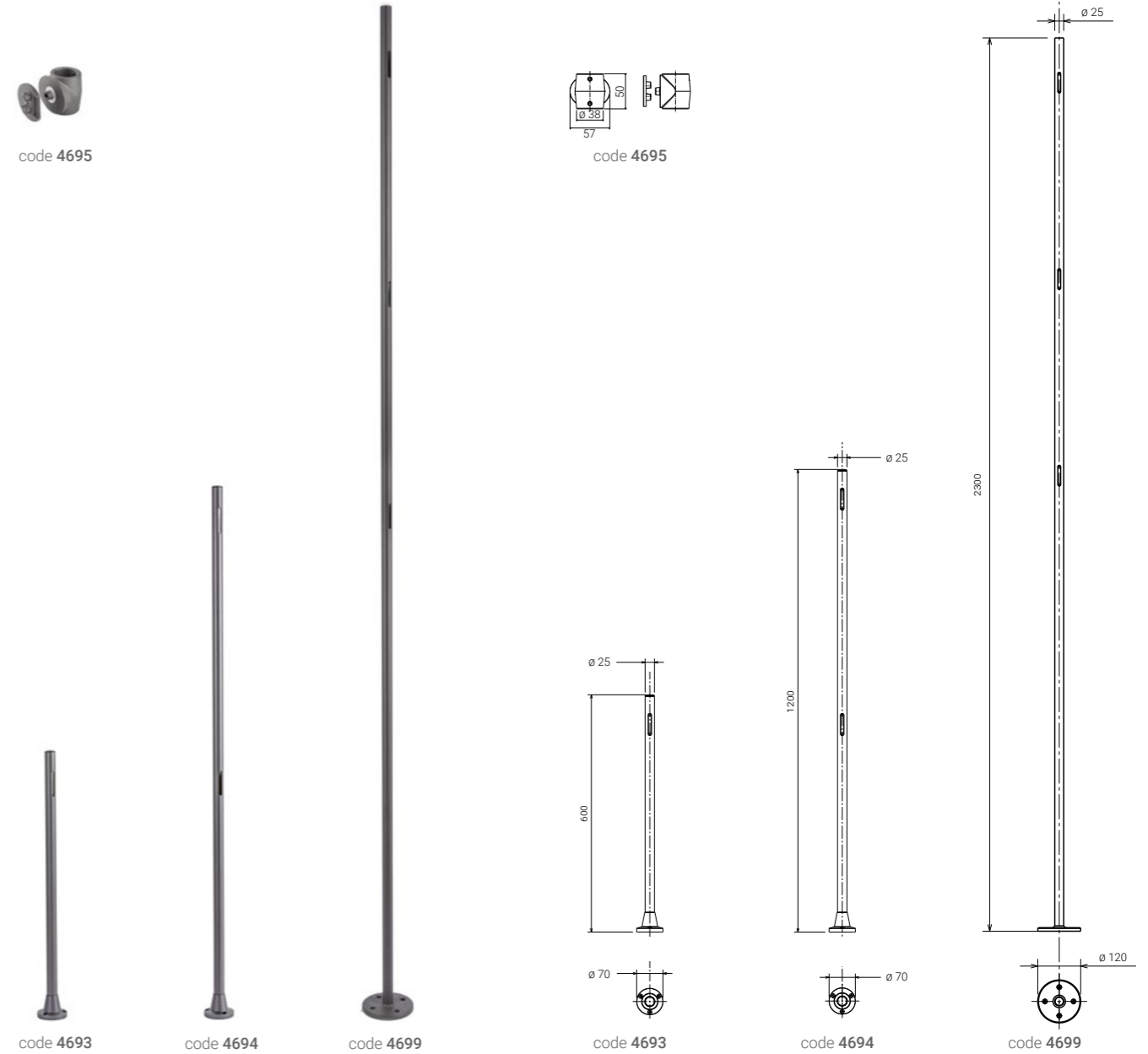

Code	Description
4693	Stelo H 600 mm (1 asola) in alluminio estruso, base in alluminio pressofuso / Stem H 600 mm (1 slot) in extruded aluminium, base in die-cast aluminium
4694	Stelo H 1200 mm (2 asole) in alluminio estruso, base in alluminio pressofuso / Stem H 1200 mm (2 slots) in extruded aluminium, base in die-cast aluminium
4699	Stelo H 2300 mm (3 asole) in acciaio, comprensivo di base / Stem H 2300 mm (3 slots) in steel, complete with base
4695	Raccordo scorrevole in alluminio pressofuso con relativa piastrina di fissaggio / Adjustable joint in die-cast aluminium with related fixing plate

4693, 4694 Max 2 cavi all'interno dello stelo / Max. 2 cables inside the stem

4699 Max 3 cavi all'interno dello stelo / Max. 3 cables inside the stem

4699 Si consiglia apparecchio CLOCK con cavo 7 m / CLOCK luminaire with 7 m cable is recommended

4694 Da montare obbligatoriamente con piastra 4697 / To be mandatorily installed with plate 4697

Su richiesta / On request

CO - corten BR - bronze

# CLOCK

Accessori / Accessories



## PICCHETTO / SPIKE



Code	Description	Ref. to
4696	Picchetto in policarbonato con piastra in acciaio inox AISI 304 / Spike in polycarbonate with plate in AISI 304 stainless steel	code 4693

## PIASTRE TIRAFONDI / PLATES WITH ANCHORING SET



code 4697



code 5538

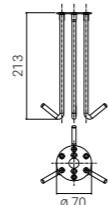

code 4697

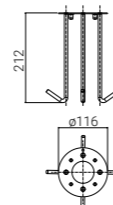

code 5538

Code	Description	Ref. to
4697	Piastra in acciaio inox AISI 304 con 3 tirafondi di ancoraggio / Plate in AISI 304 stainless steel with 3 ground anchors	code 4693 code 4694
5538	Piastra in acciaio inox AISI 304 con 4 tirafondi di ancoraggio / Plate in AISI 304 stainless steel with 4 ground anchors	code 4699

## CASSAFORMA / IN-GROUND BOX

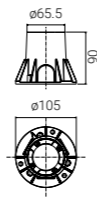

Code	Description	Ref. to
4698	Cassaforma per cablaggio interrato in tecnopolimero con anello in alluminio per fissaggio viti / In-ground box in technopolymer with aluminium ring to fix the screws	code 4693 code 4694

Accessorio opzionale per cablaggio stagno / Optional accessory for waterproof wiring (code 1941)





# PROTO



PROTO è il proiettore tondo che porta avanti l'idea di Goccia Illuminazione di dare una forma bella ad una funzione buona. Con diverse potenze, numerose possibilità di impiego del flusso luminoso e di installazione trovano spazio nell'armonia delle proporzioni per applicazioni a parete, a terra e su palo. Fuori dal coro nel suo segmento, dove il risultato prevale sull'aspetto, PROTO garantisce grande efficacia illuminotecnica e si distingue con un design sinuoso e leggero. Lo studio delle forme contribuisce a sua volta all'ottimizzazione tecnica dello spazio superiore per la dissipazione, con la copertura lenticolare per far defluire l'acqua e con l'innesto dello snodo per facilitare l'orientamento verticale. I materiali selezionati e la qualità delle finiture completano la resistenza della struttura della lampada e il suo valore estetico. Così si aggiungono nuove possibilità di applicazione rispetto alle canoniche, per cui PROTO esprime una natura versatile - un proiettore a tutto tondo.

PROTO is the round projector that carries on Goccia Illuminazione's idea of giving a nice shape to a good function. With different powers, numerous possibilities of using the luminous flux find space in the harmony of proportions for wall, ground and pole applications.

Out of the box in its category, where the result prevails over the appearance, PROTO guarantees great lighting effectiveness and stands out with a sinuous and slender design. The study of the shape contributes to the technical optimization of the upper space for dissipation, with the lenticular cover to drain the water and with the joint to facilitate vertical orientation. The selected materials and the quality of the finishes complete the resistance of the lamp structure and its aesthetic value. Thus new application possibilities are added compared to the canonical ones, whereby PROTO expresses a versatile nature - an all-round projector.

## PROJECTORS



PROTO



PROTO  
STRADA

# PROTO

## Struttura

- Corpo illuminante in alluminio pressofuso a basso tenore di rame. Il vetro frontale temprato trasparente ultrawhite è sigillato alla cornice di chiusura per consentire la massima tenuta
- Staffa di aggancio orientabile in alluminio pressofuso
- Viti laterali di fissaggio in acciaio inox in tinta

## Structure

- Lighting body in low-copper grade die-cast aluminium. The transparent ultrawhite tempered front glass is sealed to the closing frame for maximum integrity
- Adjustable hooking bracket in die-cast aluminium
- Color matching side fixing screws in stainless steel

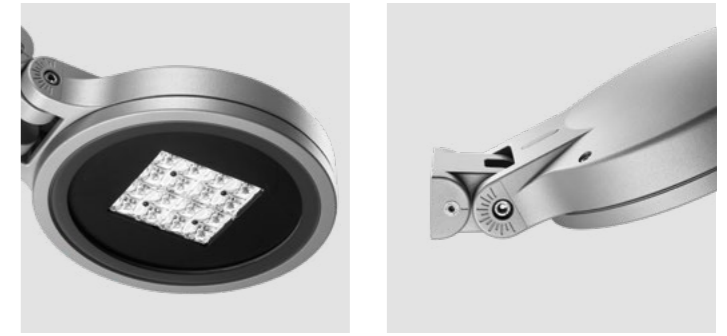
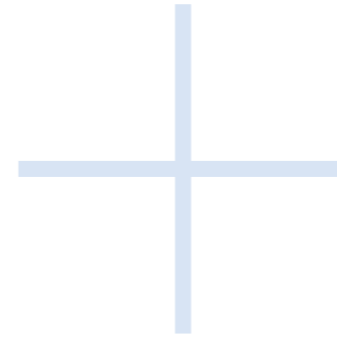

## Estetico ed eclettico

PROTO è un proiettore che si inserisce propositivamente in chiave estetica e da qui definisce il suo valore di applicazione tecnica, declinando la funzione illuminotecnica con una scelta mirata di ottiche e di lenti.

## Aesthetic and eclectic

PROTO is a projector for a purposeful use in an aesthetic key and from here defines its technical application value, declining the lighting function with a targeted choice of optics and lenses.



## PROTO

- Moduli LED a tensione di rete
- Lenti tonde simmetriche

## PROTO

- Mains voltage LED modules
- Round symmetrical lenses

## PROTO STRADA

- Moduli LED altamente performanti
- Driver incorporato
- Lenti STRADA simmetriche e asimmetriche

## PROTO STRADA

- Highly performing LED modules
- Driver incorporated
- Symmetrical and asymmetrical STRADA lenses

## PROTO RGBW

(vedi capitolo dedicato / see related chapter)



## Varietà di applicazione

Tutte le modalità di impiego, dalla facciata agli altri spazi dell'architettura, si completano con l'applicazione su palo. L'attacco per pali Ø 60 e 76 mm consente l'installazione singola o doppia contrapposta, anche sui pali della serie PROTO per l'illuminazione di aree aperte e percorsi.

## Variety of application

All the ways of installation, from the facade to different architectural spaces, are completed with the application on the pole. The connection for Ø 60 and 76 mm poles allows single or double opposed installation, even on PROTO series poles for illumination of open areas and paths.



# PROTO

Proiettori / Projectors



## PROTO

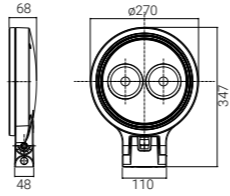

Code	
4935	● AN - anthracite 27K - 2700K 3K - 3000K
4936	● AG - aluminium grey 4K - 4000K

Lamp	W	Lm LED	Real Lm	Optic
LED	20	2200	1500	40°
	30	3150	2100	

Ottiche opzionali / Optional optics  
12° (code + 12), 90° (code + 90)

Modulo LED a tensione di rete, compatibile con dimmer a taglio di fase /  
Mains voltage LED module, compatible with most phase-cut dimmers

Fornito con 1 m di cavo / 1 m cable included

Eventuale protettore di sovratensioni da ordinare separatamente / Optional SPD to  
be ordered separately (page 309)

**Su richiesta / On request**

3 m di cavo per installazione su palo / 3 m cable for pole mounting (code + MT3)

## PROTO STRADA

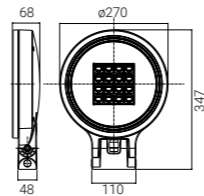

Code	
4937	● AN - anthracite 3K - 3000K
4938	● AG - aluminium grey 4K - 4000K

Lamp	W	Lm LED	Real Lm	Optic
LED	25	3008	2626	100° symmetric
	35	4212	3352	

Ottiche opzionali / Optional optics  
vedi dettagli / see details (page 117)

• simmetrica / symmetric 17° (code + 01)  
• asimmetrica / asymmetric 150° x 45° (code + 02), 90° x 30° (code + 03),  
120° x 45° (code + 04), 150° x 70° (code + 05)

Fornito con 1 m di cavo / 1 m cable included

Eventuale protettore di sovratensioni da ordinare separatamente / Optional SPD to  
be ordered separately (page 309)

**Su richiesta / On request**

Versione dimmerabile / Dimmable version

3 m di cavo per installazione su palo / 3 m cable for pole mounting (code + MT3)

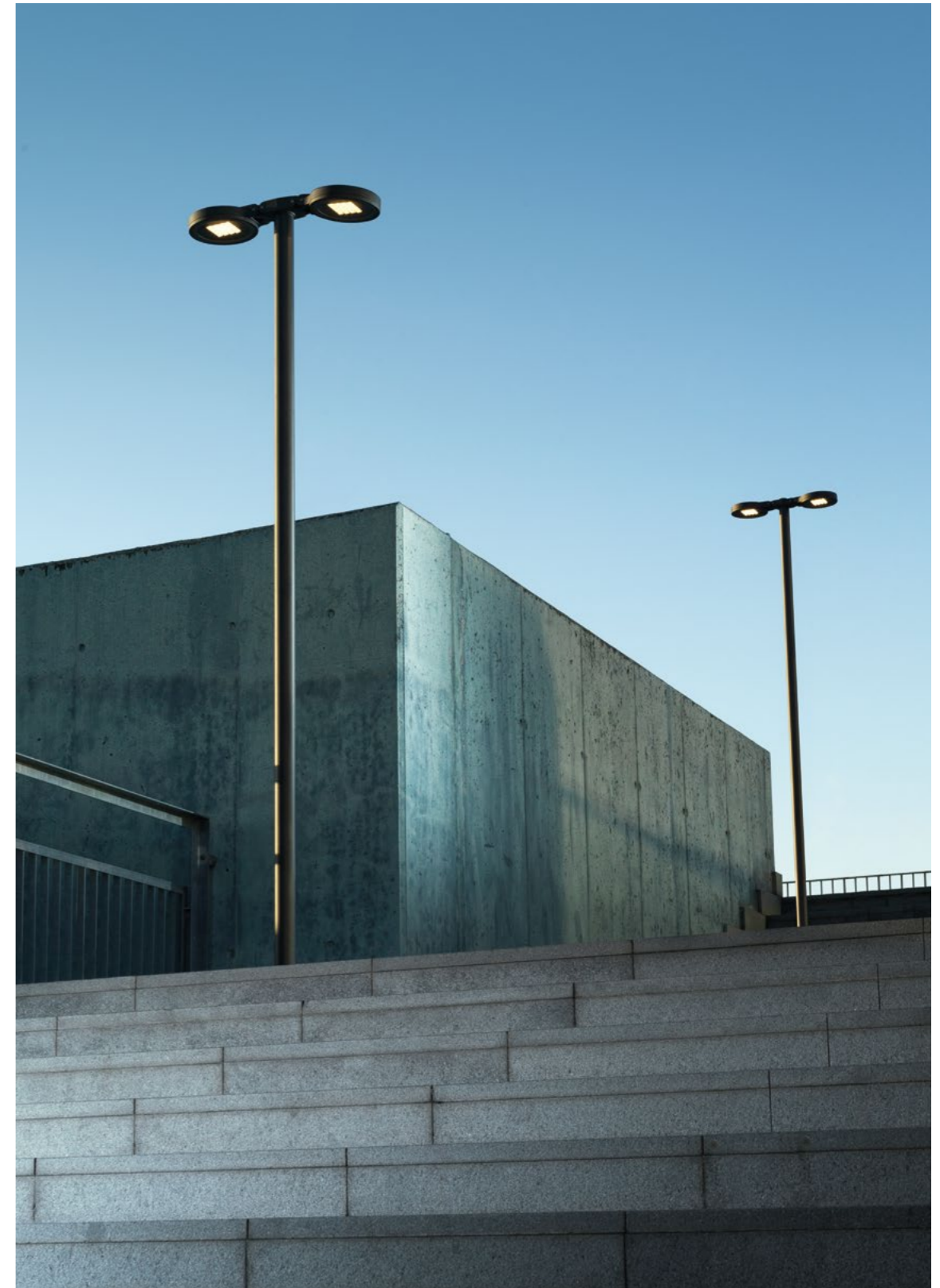





## PROTO STRADA OTTICHE / OPTICS

### SIMMETRICHE / SYMMETRIC

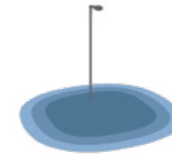

Lumen output: 3352 lm

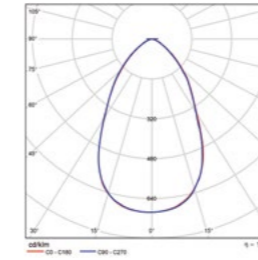

**100°** simmetrica / symmetric (standard code)  
illuminazione uniforme / uniform lighting



Lumen output: 3958 lm

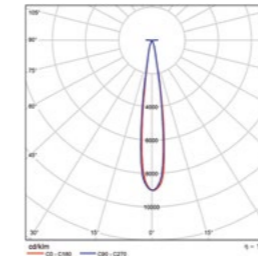

**17°** simmetrica / symmetric (code + 01)  
illuminazione d'accento e di dettaglio / accent and detail lighting

### ASIMMETRICHE / ASYMMETRIC

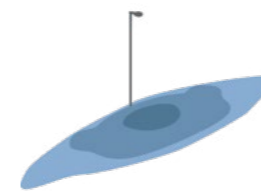

Lumen output: 3330 lm

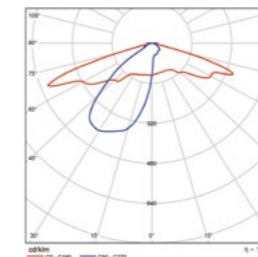

**150° x 45°** asimmetrica ciclopedonale / asymmetric cycle or pedestrian path (code + 02)  
illuminazione per zone di transito, con interdistanza elevata / lighting for transit areas, with high interdistance



Lumen output: 3420 lm

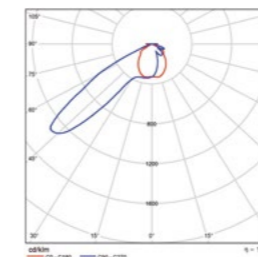

**90° x 30°** asimmetrica rettangolare / rectangular asymmetric (code + 03)  
illuminazione di profondità, come aree gioco o attraversamenti pedonali / in-depth lighting, such as play areas or pedestrian crossings

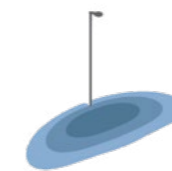

Lumen output: 3277 lm

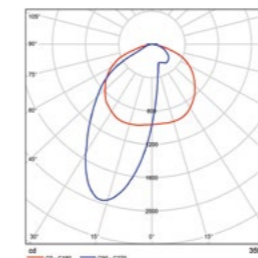

**120° x 45°** asimmetrica perimetrale / perimeter asymmetric (code + 04)  
illuminazione di spazi ampi, parcheggi, aree di accesso, di carico e scarico / lighting of large spaces, car parks, accesses, loading and unloading zones

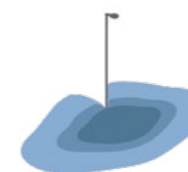

Lumen output: 3305 lm

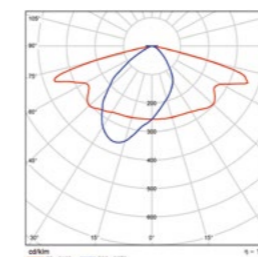

**150° x 70°** asimmetrica stradale / asymmetric street lighting (code + 05)  
illuminazione di viabilità secondaria, residenziale e a basso flusso motorizzato; la presenza di backlight (20°) permette di illuminare anche spazi retrostanti la carreggiata, come marciapiedi e percorsi ciclabili / lighting of secondary, residential and low-flow motorized roads; 20° backlight allows to illuminate spaces behind the carriageway, such as pavements and cycle paths

Lumen output code 4938



ATTACCO PALI / POLES CONNECTION



code 5061

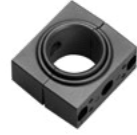

code 5062

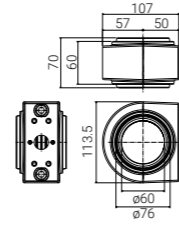

code 5061

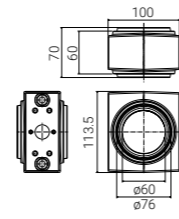

code 5062

Code	Description
5061	Attacco singolo in alluminio pressofuso per palo Ø 60 - 76 mm / Die-cast aluminium single connection for Ø 60 - 76 mm pole
5062	Attacco doppio in alluminio pressofuso per palo Ø 60 - 76 mm / Die-cast aluminium double connection for Ø 60 - 76 mm pole

PALI INTERRABILI / BURIABLE POLES



3504

● AN - anthracite

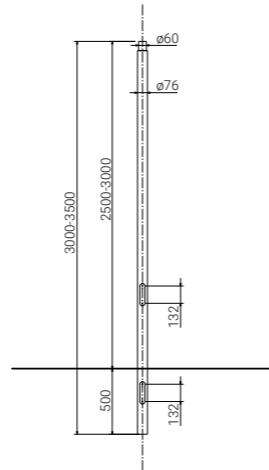

Code	H	Description
3504	3000 mm (2500 mm fuori terra / above ground)	Palo liscio in acciaio Ø 76 mm ricavato da tubo elettrosaldato, zincato a caldo e verniciato. Completo di foro ingresso cavi, attacco di messa a terra e asola con portella e morsetti. Codolo superiore di installazione Ø 60 mm / Smooth pole Ø 76 mm in steel obtained from electro-welded tube, hot-dip galvanized and painted. Complete with cable entry, earthing connection and slot with inspection door and terminal block. Top pole reduction Ø 60 mm
3505	3500 mm (3000 mm fuori terra / above ground)	

Su richiesta / On request  
Versione con basamento / Version with base





TORRETTE  
MULTIFUNZIONE

GARDEN POWER  
POINTS

# SERVER POINT



Distribuire la luce, coordinare comodamente energia, accessi, antifurto e tutti i comandi di domotica o con sensore di rilevamento della presenza dall'esterno. Questo è possibile con SERVER POINT, la torretta di distribuzione modulare dal design pulito e curato di Goccia Illuminazione. Disponibile in due altezze, SERVER POINT è attrezzato con 2 prese Schuko o industriali CEE 17 e predisposto ad accogliere da 4 a 12 moduli opzionali della serie Living International, Light e Light Tech di BTicino, a cui è possibile aggiungere un utile faretto LED segnapasso ed un rilevatore di presenza. La struttura in alluminio coniuga la resistenza con l'eleganza delle finiture.

Distribute the light, conveniently coordinate energy, access, anti-theft systems and all home automation, or with PIR sensor, outdoors. This is possible with SERVER POINT, the modular distribution tower with a clean and well-finished design by Goccia Illuminazione. Available in two heights, SERVER POINT is equipped with 2 Schuko or industrial CEE 17 sockets and designed to accommodate from 4 to 12 optional modules from the Living International, Light and Light Tech series by BTicino, to which it is possible to add a useful LED path marker and a PIR sensor. The aluminum structure combines resistance with the elegance of the finishes.

## GARDEN POWER POINTS



SERVER POINT  
1

SERVER POINT  
1

SERVER POINT  
2



# SERVER POINT

## Rilevatore di presenza

Possibilità di installare, in alternativa allo sportello porta prese, il rilevatore di presenza Goccia Illuminazione (opzionale). Se una persona o un veicolo entrano nel campo del sensore, viene comandata automaticamente l'accensione del faretto LED di SERVER POINT o una qualunque altra utenza domestica: lampade da giardino, cancello elettrico, porte automatiche, ecc. Sono possibili tre regolazioni: luminosità crepuscolare per regolare l'orario di funzionamento, area di rilevamento, temporizzazione dell'accensione.

## PIR sensor

Option of installing a Goccia Illuminazione PIR sensor (optional), in a special space, instead of the sockets door. When somebody enters in the area is detected by the PIR sensor, the switch comes on to introduce a new function: light to the LED in the same pole or to the house lights or what else. Three regulations are available: detection area, switching timing and daylight.

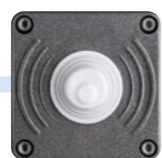

## LED segnapasso

È possibile aggiungere un utile LED segnapasso a tenuta stagna (opzionale).

## LED path marker

A useful watertight LED path marker can also be added (optional).



Alluminio estruso con piede e testa in pressofusione

Extruded aluminium with die-cast base and head

Doppia scatola cablaggio: comandi luce + energia

Dual wiring box: lighting + energy control

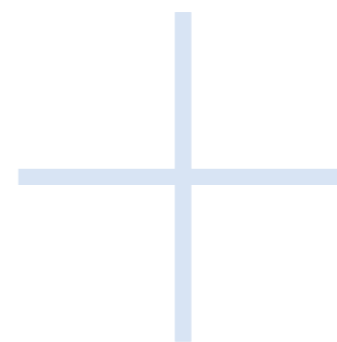

## Struttura bifacciale

Doppi ingressi sui due lati, 4/8 moduli.

## Two-sided structure

Double entries on two sides, 4/8 units.



## Dotazione prese

Fornito con due prese standard tedesco della serie Living International, Light e Light Tech di BTicino, oppure due prese industriali CEE 17. Gli sportelli liberi possono essere utilizzati per inserire altri frutti di servizio della serie Living International (interruttori/deviatori/pulsanti/interruttori automatici).

## Sockets supplied

Equipped with two German standard sockets from the Living International, Light and Light Tech series by BTicino, or two industrial CEE 17 sockets. The free panels can be used to insert other Living International series service products (switches/diverters/buttons/automatic switches).



# SERVER POINT

Torrette multifunzione / Garden power points



## SERVER POINT 1

IP 55

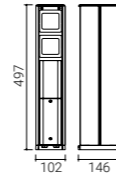

### Code

### Description

5301	AN - anthracite
------	-----------------

Struttura bifacciale con due sportelli a molla contenenti 2 prese standard Tedesco della serie Living International, Light e Light Tech di BTicino, 2 sportelli vuoti addizionali sul retro e due cassette di derivazione complete di morsettiera / Two-sided structure with two spring-loaded panels containing 2 German standard sockets from the Living International, Light and Light Tech series by BTicino, 2 additional empty panels on the back and two switching boxes complete with terminal board

## SERVER POINT 1 - CEE 17

IP 44

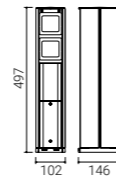

### Code

### Description

5303	AN - anthracite
------	-----------------

Struttura bifacciale con due sportelli a molla contenenti 2 prese industriali CEE 17 16A 220-250V 50/60Hz, due sportelli vuoti addizionali sul retro e due cassette di derivazione complete di morsettiera / Two-sided structure with two spring-loaded panels containing 2 industrial CEE 17 16A sockets 220-250V 50/60Hz, 2 additional empty panels on the back and two switching boxes complete with terminal board

### Su richiesta / On request

Prese industriali / Industrial sockets 3P+T 380-415V 50/60Hz

## SERVER POINT 2

IP 55

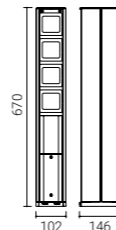

### Code

### Description

5302	AN - anthracite
------	-----------------

Struttura bifacciale con due sportelli a molla contenenti 2 prese standard Tedesco della serie Living International, Light e Light Tech di BTicino, 2 sportelli vuoti addizionali frontali, 4 sul retro e due cassette di derivazione complete di morsettiera / Two-sided structure with two spring-loaded panels containing 2 German standard sockets from the Living International, Light and Light Tech series by BTicino, 2 additional empty panels in the front, 4 on the back and two switching boxes complete with terminal board

# SERVER POINT

Accessori / Accessories



## LED SEGNAPASSO / RECESSED LED PATH MARKER

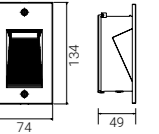

### Code

### Lamp

### W

### Lm LED

### Real Lm

### Optic

5315	AN - anthracite	3K - 3000K 4K - 4000K
------	-----------------	--------------------------

LED	4,5	265	168	asym.
-----	-----	-----	-----	-------

## RILEVATORE DI PRESENZA / PIR SENSOR

IP 65

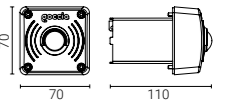

### Code

### Description

5308	AN - anthracite
------	-----------------

Rilevatore di presenza a raggi infrarossi con tre regolazioni: luminosità crepuscolare, temporizzazione, area di rilevamento / PIR sensor with three regulations: time, area, daylight

Collegabile al cod. 5315 o altri apparecchi in linea / Connectable to code 5315 or other luminaires in line

Accessorio da inserire su SERVER POINT al posto dello sportello porta prese / To be inserted on SERVER POINT instead of the sockets door

Nello sportello contrapposto non è possibile inserire prese o interruttori / The opposite door cannot contain any sockets or switches

## PIASTRA TIRAFONDI / PLATE WITH ANCHORING SET

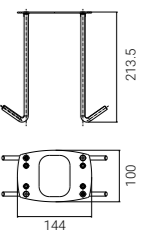

### Code

### Description

5309	Piastra inox con tirafondi per ancoraggio al terreno / Stainless Steel plate with ground anchoring set
------	--







# STANDING



Il design essenziale, la costruzione interamente in alluminio e la sorgente luminosa LED che disegna la forma conferiscono a STANDING un carattere deciso, capace allo stesso tempo di inserirsi con discrezione nel contesto. La struttura robusta ha consentito di ridurre l'ingombro e di potersi fissare su di una base senza sporgenze.

STANDING è stata progettata per diffondere la luce verso il basso, prestandosi ad illuminare percorsi, camminamenti e viali di accesso, ma con la possibilità di implementare una luce posteriore d'effetto diffusa mediante un modulo LED aggiuntivo.

The essential design, the construction entirely in aluminum and the LED light source that draws the shape give STANDING a decisive character, able at the same time to fit discreetly into the context. The robust structure made it possible to reduce the overall dimensions and to be fixable on a base without protrusions. STANDING was designed to diffuse the light downwards, lending itself to illuminate paths, walkways and access avenues, but with the possibility of implementing a diffused effect rear light using an additional LED module.

## GARDEN POST

---



STANDING



## STANDING

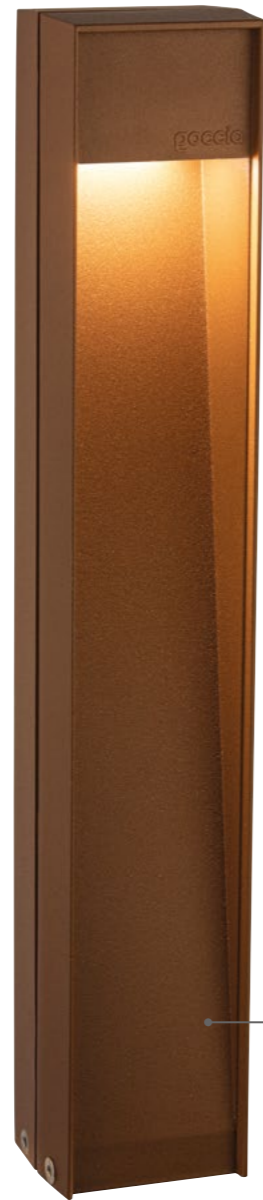

### Luce posteriore

La struttura consente l'inserimento sul retro di un secondo corpo illuminante a luce radente e diffusa.

### Back light

On the lower back the structure allows to insert a second luminaire with a diffused light.

### Struttura

Interamente in lega di alluminio primario a basso tenore di rame. Luce frontale, protetta da aletta antiabbagliamento, progettata per illuminare camminamenti, passaggi e vialetti.

### Structure

Fully made of primary aluminium alloy with low copper content. The front light, protected by an antidazzle louvre, is designed for walkways and paths.

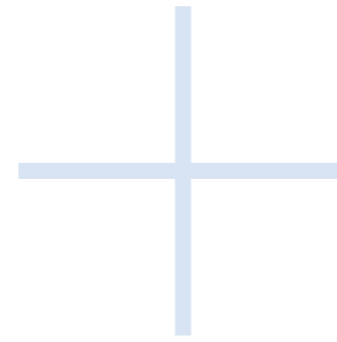

### Aletta antiabbagliante

La luce LED frontale viene direzionata verso il basso ed è protetta da aletta antiabbagliante.

### Downward light

The front LED light is directed downwards and is protected by an antidazzle louvre.



### Cablaggio interno

Il cablaggio è interno alla struttura tramite gli appositi giunti forniti separatamente. Con il giunto stagno a Y è possibile effettuare il cablaggio passante.

### Internal wiring

The wiring is inside the pole. The connections are supplied separately. The optional Y-connector allows through wiring.



# STANDING

Palo da giardino / Garden post



## PALO / POST

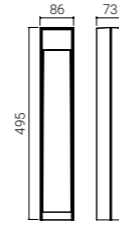

Code	
● AN - anthracite	27K - 2700K
● AG - aluminium grey	3K - 3000K
● CO - corten	4K - 4000K

Modulo LED a tensione di rete, compatibile con dimmer a taglio di fase / Mains voltage LED module, compatible with most phase-cut dimmers

Lamp	W	Lm LED	Real Lm	Optic
LED	8	800	423	-

Su richiesta / On request

● BR - bronze



# STANDING

Accessori / Accessories



## LUCE POSTERIORE / BACK LIGHT

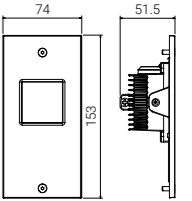

Code	
● AN - anthracite	27K - 2700K
● AG - aluminium grey	3K - 3000K
● CO - corten	4K - 4000K

Modulo LED a tensione di rete, compatibile con dimmer a taglio di fase / Mains voltage LED module, compatible with most phase-cut dimmers

Lamp	W	Lm LED	Real Lm	Optic
LED	8	800	423	-

Su richiesta / On request

● BR - bronze

## GIUNTI STAGNI / WATERPROOF CONNECTIONS

IP 68



code 1941



code 1942



code 1941

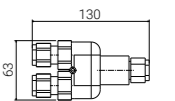

code 1942

Code	Description
1941	Connessione singola 3x2,5 mm <sup>2</sup> IP68 / Single connector 3x2,5 mm <sup>2</sup> IP 68
1942	Connessione entra-esce 3x2,5 mm <sup>2</sup> IP68 / Through wiring connector 3x2,5 mm <sup>2</sup> IP 68

## TIRAFONDI / ANCHORING SET

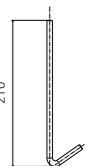

Code	Description
5529	4 tirafondi in inox per ancoraggio al terreno / 4 stainless steel ground anchors







# IANUS



La forma pura del bollard cilindrico viene intagliata in maniera scultorea e immediata per lasciar scaturire la luce. E la luce determina l'angolo del taglio e le proporzioni dell'intera composizione, per esprimersi al massimo e con eleganza.

IANUS è proposto da Goccia Illuminazione in biemissione o monodirezionale, con due diametri e diverse altezze, nelle resistenti e pregiate finiture.

La tecnologia ad alta efficienza delle sorgenti luminose si presta per molteplici tipi di installazione e versioni, fino a quella da arredo urbano IANUS URBAN, con le ottiche dedicate per l'ottimizzazione del flusso luminoso. Questa vocazione tecnica di grande attenzione all'effetto di luce mirato ed efficace rende IANUS uno strumento preciso per il progetto illuminotecnico di contesti architettonici privati residenziali e pubblici urbani.

The pure form of the cylindrical bollard is crafted in a sculptural and immediate way to let the light flow. And the light determines the angle of the cut and the proportions of the entire composition, to the maximum expression with elegance.

IANUS is proposed by Goccia Illuminazione in bi-emission or unidirectional, with two diameters and different heights, in resistant and precious finishes.

The high-efficiency technology of the light sources is suitable for multiple types of installation and versions, up to the IANUS URBAN street furniture, with dedicated optics for optimizing the luminous flux. This technical vocation of great attention to the targeted and effective light effect makes IANUS a precise tool for the lighting design of private residential and urban public architectural contexts.

## POLES



IANUS 60



IANUS 120

## URBAN LIGHTING



IANUS URBAN



# IANUS 60

## Struttura

- Testa-palo in lega di alluminio primario a basso tenore di rame
- LED schermato all'interno del diffusore
- Driver incorporato nel testa-palo

## Structure

- Pole-top in primary low-copper grade aluminium alloy
- Shielded LED inside the diffuser
- Driver incorporated in the pole-top



Il testa-palo è dotato di due pressacavi M16 per consentire l'alimentazione passante.

The pole-top is equipped with two M16 cable glands to allow through wiring.

## Pali

Pali lisci in alluminio estruso.  
Disponibili in 2 altezze: 375 mm e 800 mm.

## Poles

Smooth poles in extruded aluminum.  
Available in 2 heights: 375 mm and 800 mm.

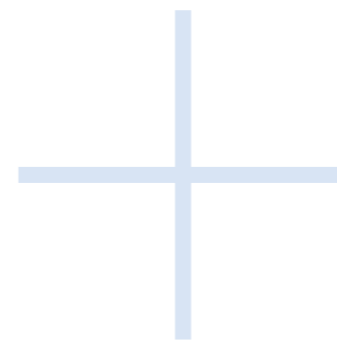

## Purezza della forma

Il volume cilindrico pulito di IANUS 60 si esprime nel taglio della sorgente luminosa, per esaltare l'effetto del piano inclinato in un equilibrio di luci ed ombre. L'accuratezza del progetto permette di ottenerlo identico in modo speculare nella versione in biemissione.

## Purity of shape

The clean cylindrical volume of IANUS 60 is expressed in the cut of the light source, to enhance the effect of the inclined plane in a balance of light and shadow. The accuracy of the project allows it to be identical in the double emission version specularly.

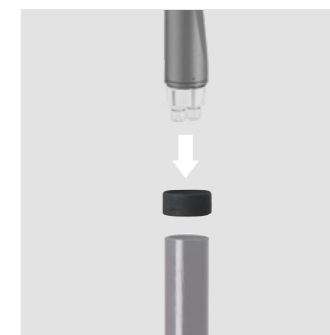

## Adattatore per pali Ø 60 mm

Gli apparecchi IANUS 60 possono essere installati e fissati mediante uno speciale raccordo anche su qualsiasi palo di mercato di Ø 60 mm.

## Adaptor for Ø 60 mm poles

The IANUS 60 luminaires can also be installed and fixed by means of a special adaptor on any standard Ø 60 mm pole.

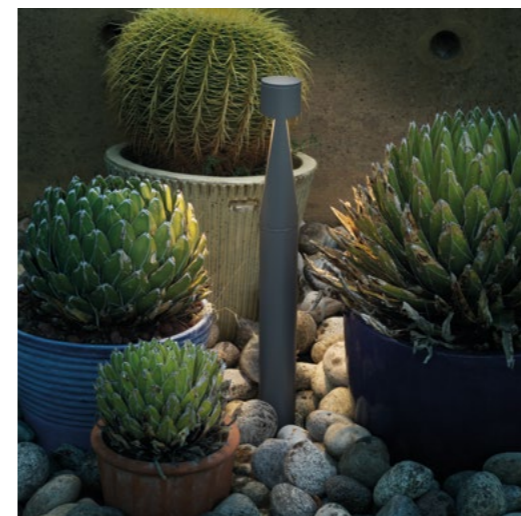

# IANUS 60

Pali da giardino / Garden poles



## CORPI LAMPADA / LIGHT BODIES Ø 60 mm

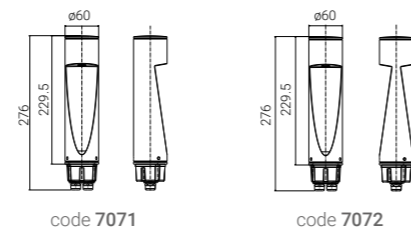

Code		
7071	● AN - anthracite	27K - 2700K 3K - 3000K
7072	● AG - aluminium grey	4K - 4000K

Lamp	W	Lm LED	Real Lm	Optic
LED	4,6	430	115	diffuse
	8	860	230	

**Su richiesta / On request**

7071 12-24V low voltage (code + LV)

● BR - bronze

# IANUS 60

Accessori / Accessories



## PALI / POLES



Code	H	Description
3401	375 mm	Palo liscio in alluminio estruso, comprensivo di basetta interna di ancoraggio in alluminio pressofuso / Smooth pole in extruded aluminium with incorporated internal fixing base in die-cast aluminium
3402	800 mm	

Si raccomanda l'installazione con piastra cod. 5518 / Installation with anchor plate code 5518 is recommended

Versione con base esterna / External ground fixing base version (page 173)



**Su richiesta / On request**

● BR - bronze



## PIASTRA TIRAFONDI / PLATE WITH ANCHORING SET

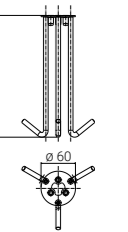

Code	Description
5518	Piastra inox con tirafondi per ancoraggio al terreno / Stainless steel plate with ground anchoring set

## RACCORDO PER PALI STANDARD / ADAPTOR FOR STANDARD POLES Ø 60 mm

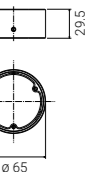

Code	Description
5506	Raccordo in alluminio primario pressofuso, adattabile a qualsiasi palo Ø 60 mm / Adaptor in die-cast primary aluminium, to be installed on any pole Ø 60 mm



# IANUS 120

## Struttura

- Interamente in lega di alluminio primario a basso tenore di rame
- Sorgente luminosa inserita all'interno dello schermo lenticolare in policarbonato opale fotoinciso per un'ampia e uniforme apertura della luce
- Viti di chiusura laterali in acciaio inox in tinta

## Structure

- Entirely in primary low-copper grade aluminium alloy
- Light source inside the photo-etched lenticular opal diffuser for a wide and uniform light distribution
- Color matching side-locking stainless steel screws



Cablaggio stagno con spezzone di cavo in dotazione che alimenta il driver integrato. Secondo ingresso M16 disponibile per cablaggio aggiuntivo, posizionato nella parte inferiore del tappo di chiusura in tecnopolimero.

Watertight wiring through the supplied cable that powers the integrated driver. Further M16 entry for additional wiring, positioned in the lower part of the closing cap in technopolymer.



## Monolitico

La semplicità della forma e delle linee pure di IANUS 120 ne conferiscono il carattere forte e di robustezza che viene concretizzato con la realizzazione tramite un unico stampo di pressofusione in lega di alluminio primario, riducendo inoltre al minimo le parti visibili.

## Monolithic

The simplicity of the shape and pure lines of IANUS 120 give it a strong and robust character, which is materialized with the realization through a single die-casting mold in primary aluminum alloy, reducing the visible parts to a minimum.

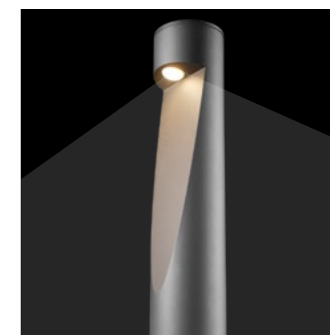

## Progettato per la resa luminosa

La ricerca geometrica e delle proporzioni ha consentito l'ideale posizionamento della sorgente luminosa di IANUS 120. La particolare forma del diffusore opalizzato permette di massimizzare l'output e l'apertura della luce.

## Designed for luminous performance

The research of geometry and proportions allowed the ideal positioning of the IANUS 120 light source. The particular shape of the opalized diffuser allows to maximize the output and the width of the light.



# IANUS 120

Pali da giardino e arredo urbano / Garden poles and urban lighting



## IANUS 120 H 600

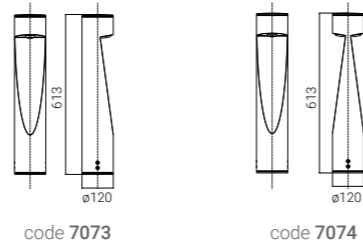
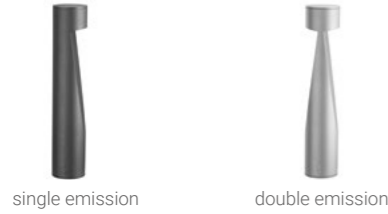

Code		
7073	● AN - anthracite	27K - 2700K 3K - 3000K
7074	● AG - aluminium grey	4K - 4000K

Lamp	W	Lm LED	Real Lm	Optic
LED	8	951	515	diffuse
	15	1902	1030	

Palo completo, cavo in dotazione / Complete fitting, cable supplied

**Su richiesta / On request**  
Versione dimmerabile / Dimmable version  
● BR - bronze

## IANUS 120 H 1000

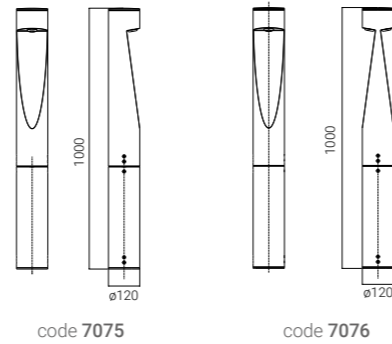
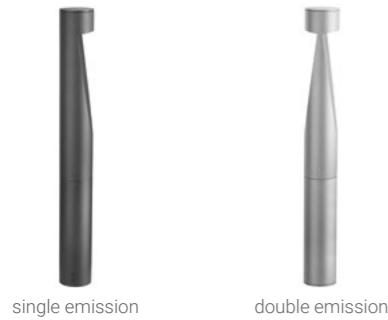

Code		
7075	● AN - anthracite	27K - 2700K 3K - 3000K
7076	● AG - aluminium grey	4K - 4000K

Lamp	W	Lm LED	Real Lm	Optic
LED	8	951	515	diffuse
	15	1902	1030	

Palo completo, cavo in dotazione / Complete fitting, cable supplied

**Su richiesta / On request**  
Versione dimmerabile / Dimmable version  
● BR - bronze

## PIASTRA TIRAFONDI / PLATE WITH ANCHORING SET

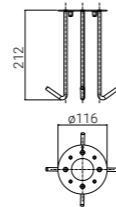

Code	Description
5538	Piastra inox con tirafondi per ancoraggio al terreno / Stainless steel plate with ground anchoring set

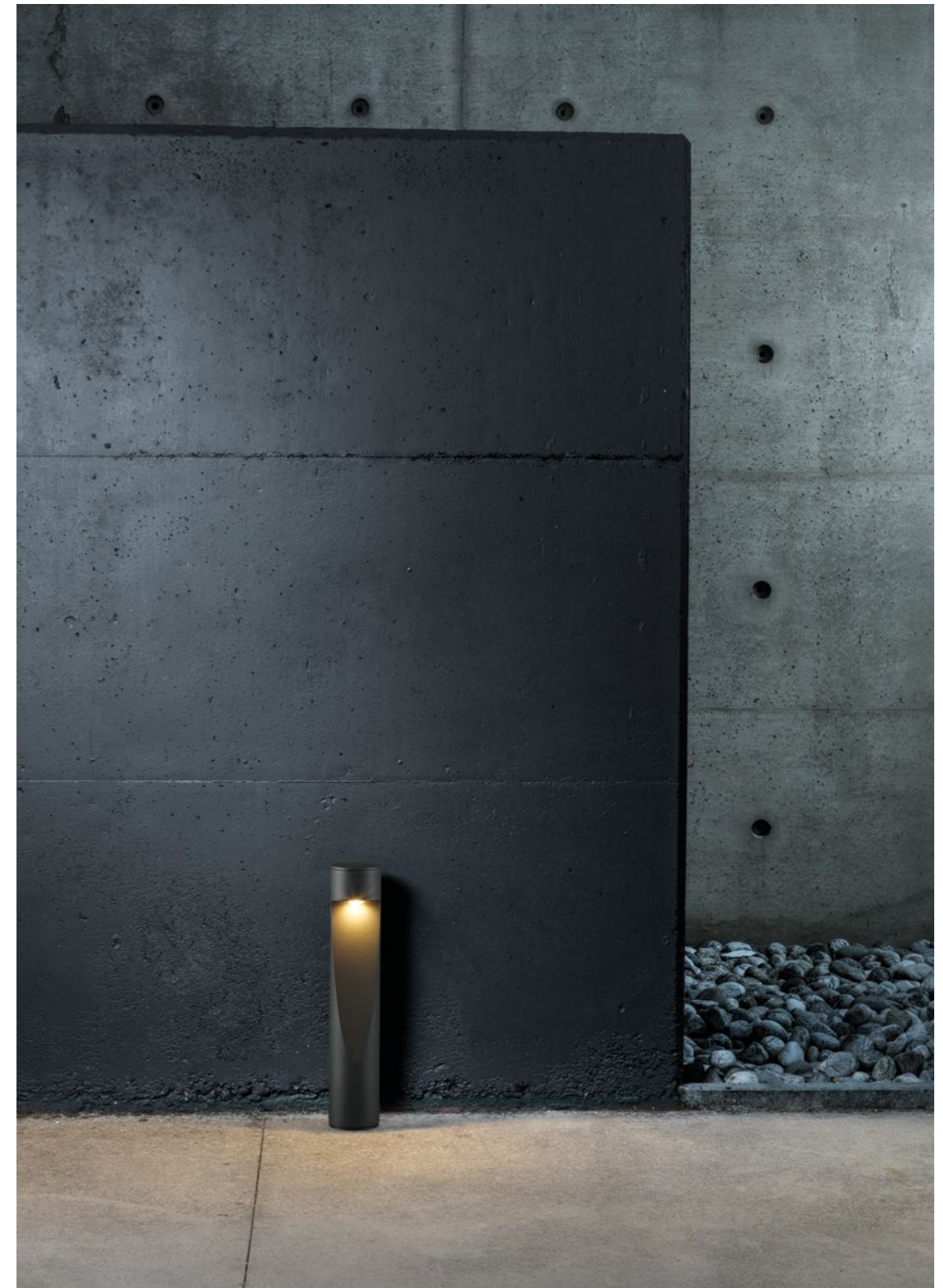





## Struttura

- Corpo illuminante Ø 120 mm in alluminio pressofuso a basso tenore di rame accoppiato in continuità con palo in alluminio estruso
- Sorgente luminosa recessa per accogliere ottiche dedicate
- Schermo lenticolare in policarbonato fotoinciso
- Viti di chiusura laterali in acciaio inox in tinta

## Structure

- Lighting body Ø 120 mm in low-copper grade die-cast aluminium coupled in continuity with extruded aluminum pole
- Recessed light source with dedicated lenses
- Photo-etched lenticular polycarbonate diffuser
- Color matching side locking stainless steel screws

Cablaggio stagno con spezzone di cavo in dotazione che alimenta il driver integrato. Secondo ingresso M16 disponibile per cablaggio aggiuntivo, posizionato nella parte inferiore del tappo di chiusura in tecnopolimero.

Watertight wiring through the supplied cable that powers the integrated driver. Further M16 entry for additional wiring, positioned in the lower part of the closing cap in technopolymer.

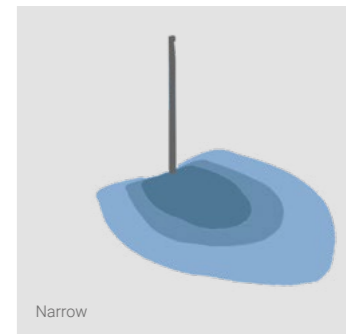
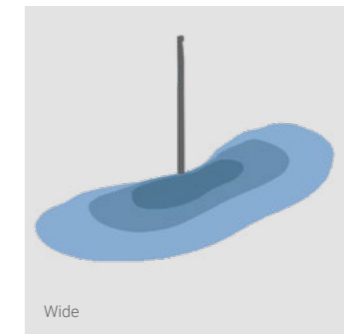
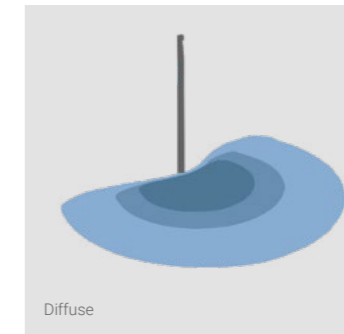
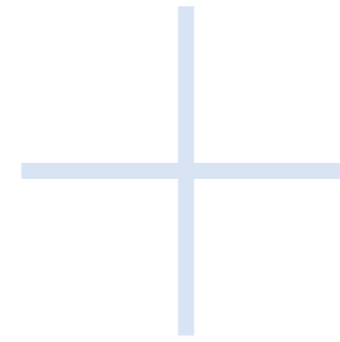

## Illuminazione urbana

Per rispondere alle necessità di illuminazione cittadina e di contesti residenziali più estesi, IANUS URBAN abbina ai LED ad alto rendimento lenti e ottiche apposite per ottenere il risultato più corretto - sono disponibili fasci luminosi ad ampia diffusione e asimmetrici.

## Urban lighting

To meet the needs of urban lighting and larger residential contexts, IANUS URBAN combines high-performance LEDs with special lenses and optics to obtain the best result - wide diffusion and asymmetric light beams are available.



## Solidità di installazione

Abbinato al palo, IANUS URBAN nelle soluzioni mono- e bifacciali dispone di solide modalità di installazione con un'attenzione al risultato estetico, grazie all'interramento del palo o al basamento in superficie.

## Solidity of installation

Combined with the pole, IANUS URBAN in single- and double-sided solutions allows solid ways of installation with a focus on the aesthetic result, thanks to the buriable pole mounting or to the surface mounting with base.

# IANUS URBAN

Arredo urbano / Urban lighting



## IANUS URBAN INTERRABILE / BURIABLE H 2400



single emission double emission

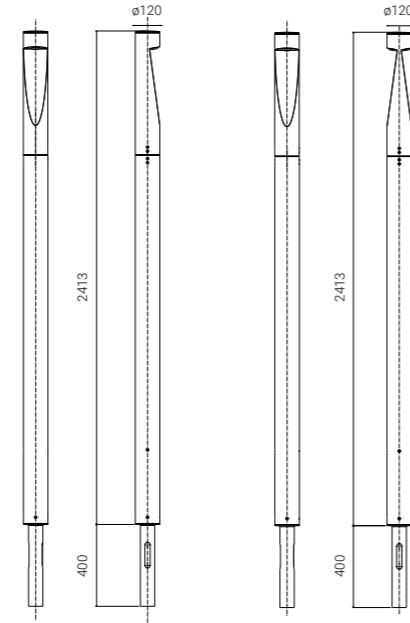

code 7081 code 7082

### Code

Code	Color	Temperature
7081	● AN - anthracite	27K - 2700K 3K - 3000K
7082	● AG - aluminium grey	4K - 4000K

Ottiche opzionali / Optional optics  
asimmetrica / asymmetric wide (code + W), narrow (code + N)

Palo completo con ancoraggio interrabile e cavo /  
Complete fitting with buriable anchoring unit and cable

Eventuale protettore di sovratensioni da ordinare separatamente / Optional SPD to  
be ordered separately (page 309)

### Lamp W Lm LED Real Lm Optic

Lamp	W	Lm LED	Real Lm	Optic
LED	16	1952	934	diffuse
	32	3904	1868	

### Su richiesta / On request

Versione dimmerabile / Dimmable version

● BR - bronze

# IANUS URBAN

Arredo urbano / Urban lighting



## IANUS URBAN CON BASAMENTO / WITH BASE H 2400



single emission double emission

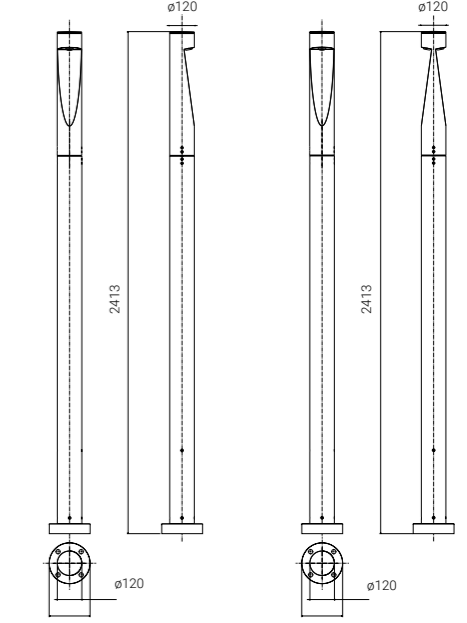

code 7083 code 7084

### Code

Code	Color	Temperature
7083	● AN - anthracite	27K - 2700K 3K - 3000K
7084	● AG - aluminium grey	4K - 4000K

Ottiche opzionali / Optional optics  
asimmetrica / asymmetric wide (code + W), narrow (code + N)

Palo completo con basamento e cavo / Complete fitting with base and cable

Eventuale protettore di sovratensioni da ordinare separatamente / Optional SPD to  
be ordered separately (page 309)

### Lamp W Lm LED Real Lm Optic

Lamp	W	Lm LED	Real Lm	Optic
LED	16	1952	934	diffuse
	32	3904	1868	

### Su richiesta / On request

Versione dimmerabile / Dimmable version

● BR - bronze

## TIRAFONDI / ANCHORING SET

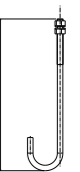

### Code

5527

### Description

4 tirafondi in acciaio per ancoraggio al terreno / 4 steel ground anchors

### Ref. to

code 7083  
code 7084







# T-LUX



Nella continuità creativa dell'esperienza nella luce per esterni Goccia Illuminazione porta avanti la sua storia con un altro capitolo, la serie T-LUX. Essenziale nella semplicità delle forme e contraddistinta dalla riconoscibilità dell'elemento che completa la composizione come una T - questo è il disco compatto della sorgente luminosa che nelle diverse applicazioni e dimensioni si coniuga con la propria necessità illuminotecnica, offrendo inoltre un effetto scenico discreto e puntuale. Concepita per gli spazi all'aperto alla ricerca di un comfort e una vivibilità assimilabile a quella degli ambienti interni, la natura estetica di T-LUX ha beneficiato di questa influenza di tipo decorativo nelle forme e nelle finiture, esaltate dalla combinazione dei colori. Questa è dunque confluita in due versioni su palo, uno stelo ed un bollard, ed in quella a parete, senza perdere il soprannome intuitivo ed evocativo che le ha accompagnate per tutte le fasi di progetto, rispettivamente: STAN, OLLIE e BOWLER o "bombetta".

In the creative continuity of the experience in outdoor lighting Goccia Illuminazione develops its story with another chapter, the T-LUX series. Essential in the simplicity of the shapes and distinguished by the recognizability of the element completing the composition as a T - this is the thin disk of the light source which is combined in different applications and sizes with its own lighting needs, also offering a discreet and precise scenic effect. Designed for outdoor spaces in search of comfort and liveability comparable to that of indoor environments, the aesthetic nature of T-LUX has benefited from this decorative influence in the shapes and finishes, enhanced by the combination of colors. This is therefore merged into two versions on pole, a stem and a bollard, and in the wall version, without losing the intuitive and evocative nickname that accompanied them for all the project phases, respectively: STAN, OLLIE and BOWLER.

## POLES



T-LUX OLLIE



T-LUX STAN

## WALL EFFECTS



T-LUX BOWLER



## T-LUX OLLIE

**Diffusore** in policarbonato fotoinciso per prevenire l'abbagliamento orizzontale e garantire un elevato output verso il basso.

Photo-etched polycarbonate **diffuser** to prevent horizontal glare and to grant high output downwards.

**Disco superiore** dissipante in alluminio pressofuso a basso tenore di rame; la particolare forma convessa evita il ristagno dell'acqua.

Dissipating **upper disc** in die-cast aluminium with low copper content; the particular convex shape avoids water stagnation.

**Cono** in alluminio pressofuso a basso tenore di rame; maggiore diffusione della luce nella finitura grigio alluminio, minima dispersione verso l'alto nella finitura antracite.

**Cone** in die-cast aluminium with low copper content; higher light diffusion in the aluminium grey finish, minimum upward light dispersion in the anthracite finish.

**Cablaggio** stagno con spezzone di cavo in dotazione che alimenta il driver integrato. Secondo ingresso M16 disponibile per cablaggio aggiuntivo, posizionato nella parte inferiore del tappo di chiusura in tecnopolimero.

Watertight **wiring** through the supplied cable that powers the integrated driver. Further M16 entry for additional wiring, positioned in the lower part of the closing cap in technopolymer.

### Robusto e versatile

La versatilità di installazione di OLLIE si articola in tre altezze di pali in alluminio estruso a disposizione per diversi scenari di illuminazione, con un montaggio robusto e semplice.

### Robust and versatile

The versatility of OLLIE's installation is divided into three heights of extruded aluminum poles available for different lighting scenarios, with a robust and simple mounting.

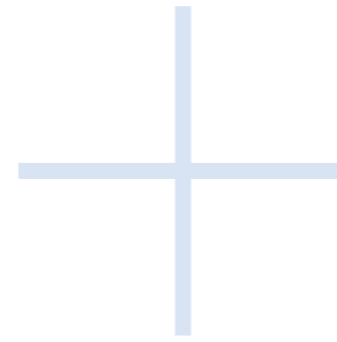

### Bollard con brio

Nell'accoppiamento tra il palo Ø 120 mm e il disco superiore Ø 150 mm OLLIE definisce la sua qualità illuminotecnica ed estetica, che trova la sua massima espressione nel cono di raccordo - un solido bollard che mantiene una leggerezza dello stile.

### Bollard with brio

In the coupling between the Ø 120 mm pole and the Ø 150 mm upper disc OLLIE defines its lighting and aesthetic quality, which finds its maximum expression in the connection cone - a solid bollard that maintains a lightness of style.

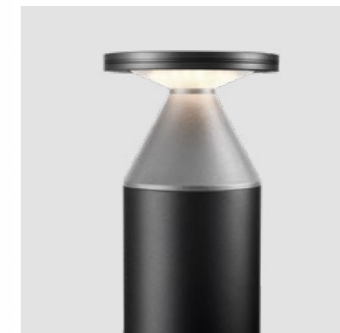

### Carattere nella composizione

Diventa versatile anche la scelta del carattere che OLLIE può assumere, con una combinazione delle finiture bicromatica o in tinta unita, per accentuare l'effetto della luce o inserirsi discretamente nei diversi contesti.

### Character in the composition

The choice of character that OLLIE can take on also becomes versatile, with a combination of two-tone or solid color finishes, to accentuate the light or discreetly fit into different contexts.

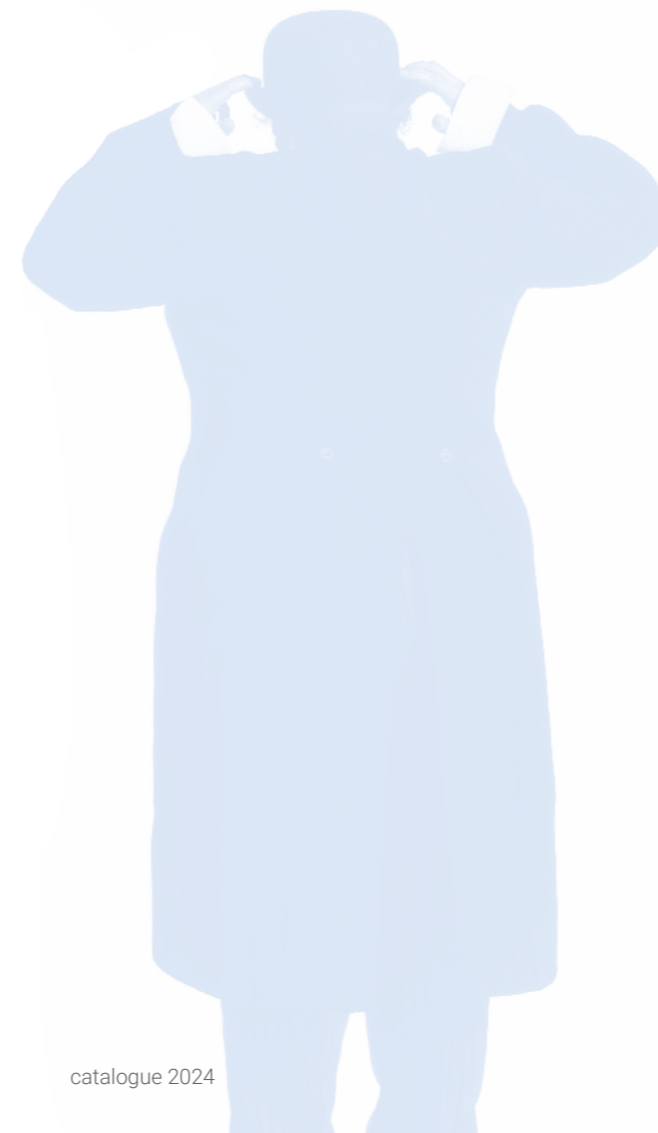

# T-LUX OLLIE

Pali / Bollards



## CORPO LAMPADA / LIGHT BODY



Code	Lamp	W	Lm LED	Real Lm	Optic
5553	LED	12,5	1725	968	diffuse

Code	Lamp	W	Lm LED	Real Lm	Optic
● AN - anthracite					
● AG - aluminium grey					
● AGAN - aluminium grey + anthracite					
● ANAG - anthracite + aluminium grey					

Cavo in dotazione / Cable supplied

Su richiesta / On request

24V low voltage (code + 24V)

Versione dimmerabile / Dimmable version

● BR - bronze



# T-LUX OLLIE

Accessori / Accessories



## PALI / POLES



Code	H	Description
3601	200 mm	Palo liscio in alluminio estruso, comprensivo di basetta interna di ancoraggio in alluminio pressofuso / Smooth pole in extruded aluminium with incorporated internal fixing base in die-cast aluminium
3602	400 mm	
3603	700 mm	

## PIASTRA TIRAFONDI / PLATE WITH ANCHORING SET

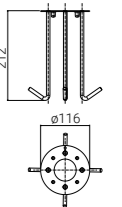

Code	Description
5538	Piastra inox con tirafondi per ancoraggio al terreno / Stainless steel plate with ground anchoring set

## SAGOMATORE / BEAM LIMITER

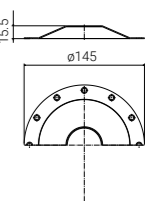

Code	Description
5555	Sagomatore 180° in alluminio / Aluminium 180° beam limiter



## T-LUX STAN

**Diffusore** in policarbonato fotoinciso per prevenire l'abbagliamento orizzontale e garantire un elevato output verso il basso, grazie anche al diametro del modulo LED a tensione di rete che occupa interamente lo spazio interno dedicato.

Photo-etched polycarbonate **diffuser** to prevent horizontal glare and to grant high output downwards, thanks also to the diameter of the mains voltage LED module, that completely occupies the dedicated internal space.



**Disco superiore** dissipante in alluminio pressofuso a basso tenore di rame; la particolare forma convessa evita il ristagno dell'acqua.

Dissipating **upper disc** in die-cast aluminium with low copper content; the particular convex shape avoids water stagnation.

**Cablaggio** stagno con spezzone di cavo in dotazione.

Watertight **wiring** through the cable supplied.

**Montaggio semplificato** grazie al raccordo filettato, senza viti a vista.

**Easier installation** thanks to the threaded connection, without visible screws.

### Steli

Steli in alluminio estruso disponibili in tre altezze: 300, 600 e 900 mm. La base in alluminio pressofuso consente l'installazione con picchetto, piastra tirafondi o cassaforma.

### Stems

Extruded aluminium stems available in three heights: 300, 600 and 900 mm. The die-cast aluminium base allows installation with spike, anchoring plate or in-ground box.

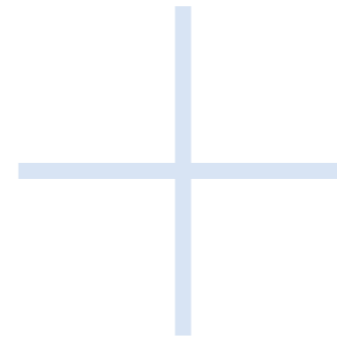

### Stelo di luce

Un'illuminazione mirata e uniforme che scaturisce dalla forma esile di STAN, in sintonia con un paesaggio arboreo o con un ambiente costruito definito e minimale.

### Stem of light

A targeted and uniform lighting that comes from the slender shape of STAN, in harmony with an arboreal landscape or with a defined and minimal built environment.



### Stelo versatile

Per calibrare l'effetto luminoso nel contesto STAN dispone di lampade in due diametri e di pali in diverse altezze, le cui proporzioni consentono anche combinazioni multiple espressive.

### Versatile stem

To calibrate the lighting effect in the context, STAN has lamps in two diameters and poles in different heights, whose proportions also allow multiple expressive combinations.

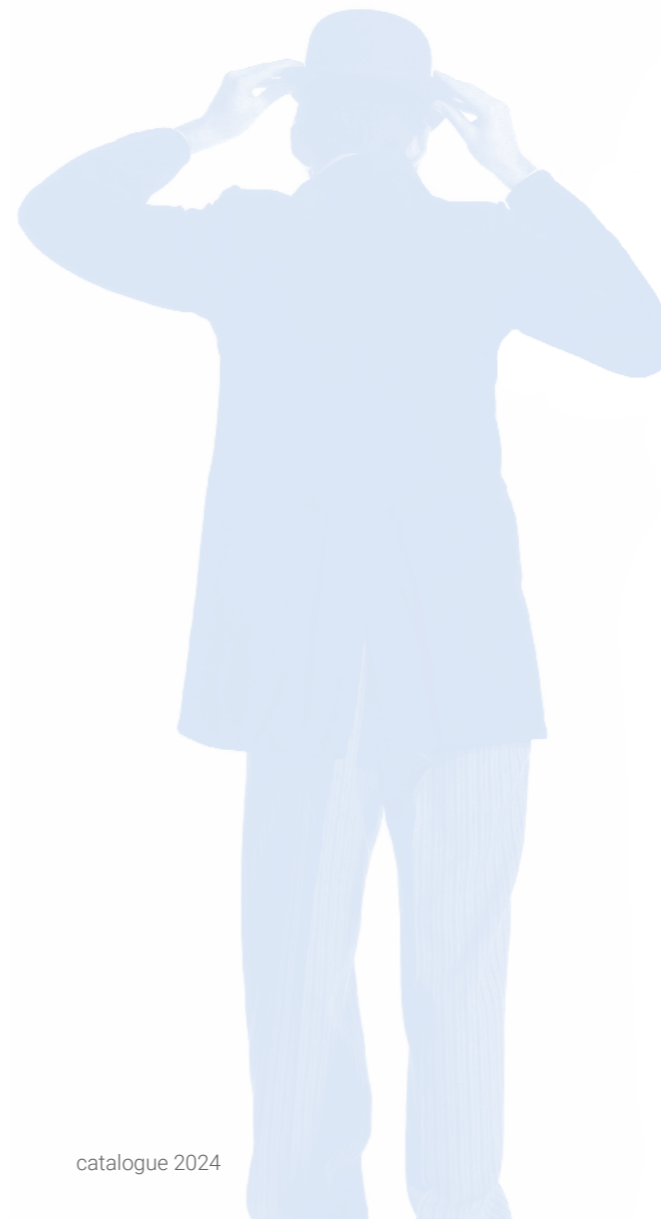

# T-LUX STAN

Steli da giardino / Garden stems



## CORPO LAMPADA / LIGHT BODY Ø 150 mm

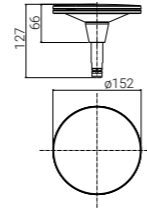

### Code

5551	● AN - anthracite	27K - 2700K
	● 3K - 3000K	
	● AG - aluminium grey	4K - 4000K

Fornito con 1,5 m di cavo / 1,5 m cable included

Modulo LED a tensione di rete, compatibile con dimmer a taglio di fase / Mains voltage LED module, compatible with most phase-cut dimmers

Compatibile con sagomatore / Compatible with beam limiter (code 5555)

Lamp	W	Lm LED	Real Lm	Optic
LED	10	1150	753	diffuse

### Su richiesta / On request

24V low voltage (code + 24V)

Lunghezza cavo 7 m / 7 m cable length (code + MT7)

● VE - green ● CO - corten ● BR - bronze

## CORPO LAMPADA / LIGHT BODY Ø 200 mm

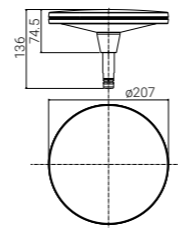

### Code

5552	● AN - anthracite	27K - 2700K
	● 3K - 3000K	
	● AG - aluminium grey	4K - 4000K

Fornito con 1,5 m di cavo / 1,5 m cable included

Modulo LED a tensione di rete, compatibile con dimmer a taglio di fase / Mains voltage LED module, compatible with most phase-cut dimmers

Lamp	W	Lm LED	Real Lm	Optic
LED	20	2300	1602	diffuse

### Su richiesta / On request

24V low voltage (code + 24V)

Lunghezza cavo 7 m / 7 m cable length (code + MT7)

● VE - green ● CO - corten ● BR - bronze

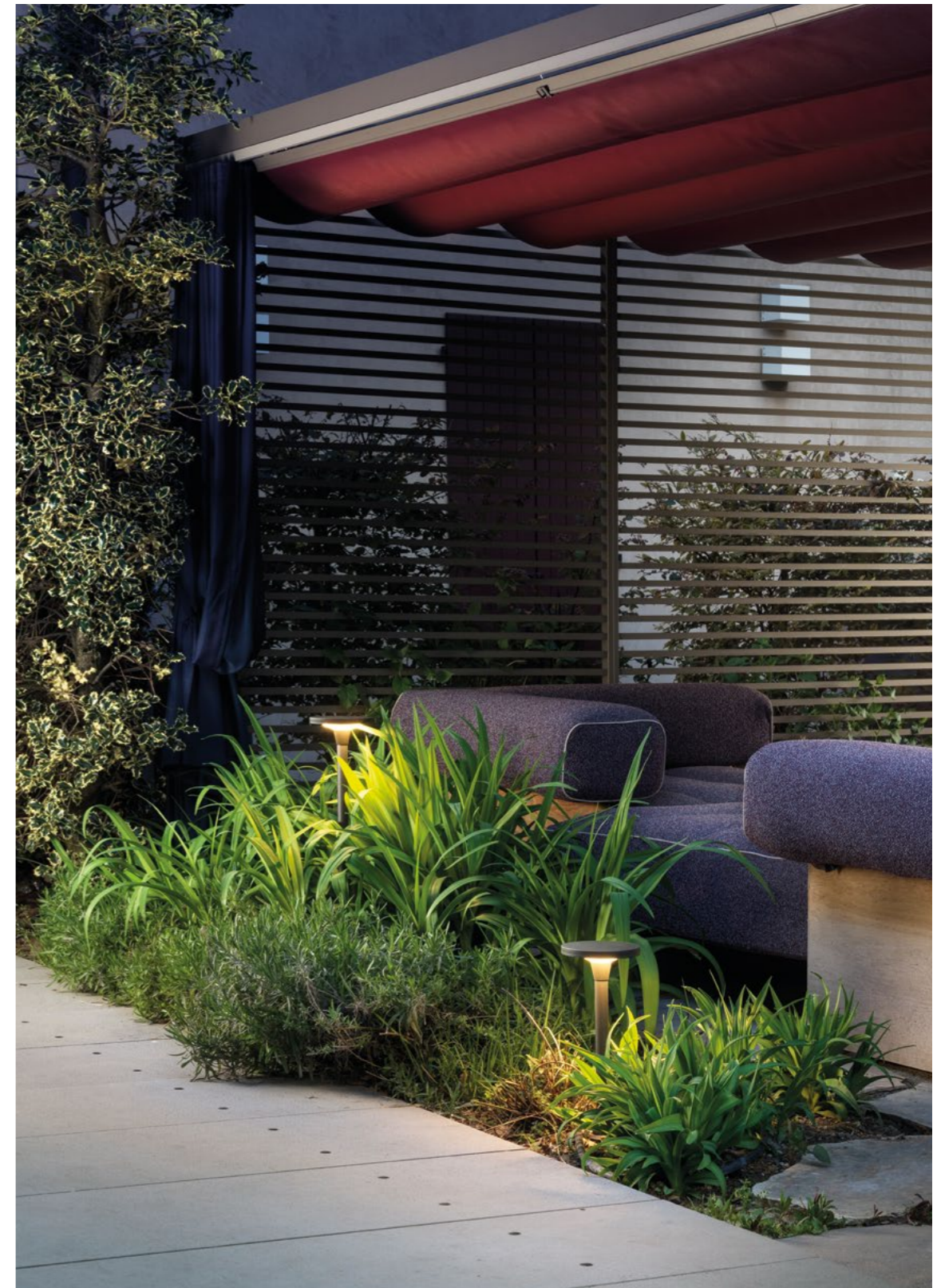



# T-LUX STAN

Accessori / Accessories



## STELI / STEMS

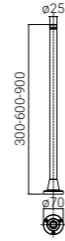
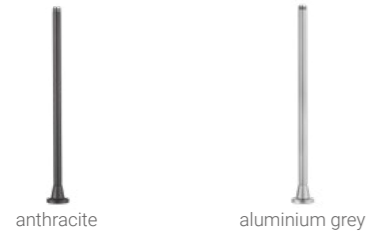

Code	H	Description	Ref to
3101	300 mm	Stelo in alluminio estruso, comprensivo di basetta in alluminio pressofuso / Stem in extruded aluminium with base in die-cast aluminium	code 5551
3102	600 mm		code 5551 code 5552
3103	900 mm		code 5552

Su richiesta / On request  
 ● VE - green ● CO - corten ● BR - bronze

## PICCHETTO / SPIKE

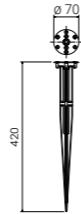

Code	Description	Ref. to
4696	Picchetto in policarbonato con piastra in acciaio inox AISI 304 / Spike in polycarbonate with plate in AISI 304 stainless steel	code 3101 code 3102

# T-LUX STAN

Accessori / Accessories



## PIASTRA TIRAFONDI / PLATE WITH ANCHORING SET

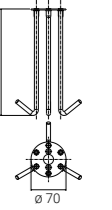

Code	Description	Ref. to
4697	Piastra in acciaio inox AISI 304 con tre tirafondi di ancoraggio / Plate in AISI 304 stainless steel with 3 ground anchors	code 3101 code 3102 code 3103

## CASSAFORMA / IN-GROUND BOX

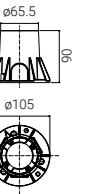

Code	Description	Ref. to
4698	Cassaforma per cablaggio interrato in tecnopolimero con anello in alluminio per fissaggio viti / In-ground box in technopolymer with aluminium ring to fix the screws	code 3101 code 3102 code 3103

Accessorio opzionale per cablaggio stagno / Optional accessory for waterproof wiring (code 1941)

## T-LUX BOWLER

**Cono** in alluminio pressofuso a basso tenore di rame, la cui armoniosa forma racchiude il cablaggio e accompagna il flusso luminoso verso la parete.

**Cone** in die-cast aluminium with low copper content; its harmonious shape contains the wiring and guides the luminous flux towards the wall.



**Disco** dissipante in alluminio pressofuso a basso tenore di rame.

Dissipating **disc** in die-cast aluminium with low copper content.

**Diffusore** in policarbonato fotoinciso per prevenire l'abbagliamento laterale e garantire un effetto omogeneo con luce diffusa a 360°, grazie anche al diametro del modulo LED a tensione di rete che occupa interamente lo spazio interno dedicato.

Photo-etched polycarbonate **diffuser** to prevent side glare and to grant a homogeneous effect with 360° diffused light, thanks also to the diameter of the mains voltage LED module, that completely occupies the dedicated internal space.

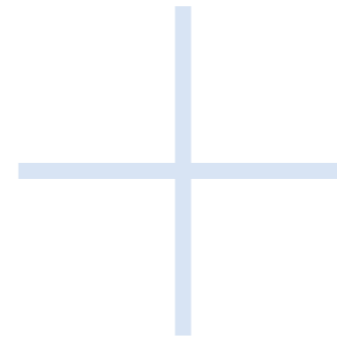

### Hat trick

Il principio compositivo della sorgente luminosa celata ed evocativa è interpretato con BOWLER come effetto a parete, a completamento dell'atmosfera di luce d'ambiente che caratterizza la serie.

### Hat trick

The compositional principle of the concealed and evocative light source is interpreted with BOWLER as a wall effect, completing the ambient light atmosphere that characterizes the series.



### Punto - luce - effetto

La forma intuitiva della luce diventa un punto decorativo, o un motivo di punti, da disegnare suggestivamente con una scelta tra due diametri, 150 e 200 mm.

### Point - light - effect

The intuitive shape of the light becomes a decorative point, or a motif of points, to be drawn suggestively with a choice between two diameters, 150 and 200 mm.

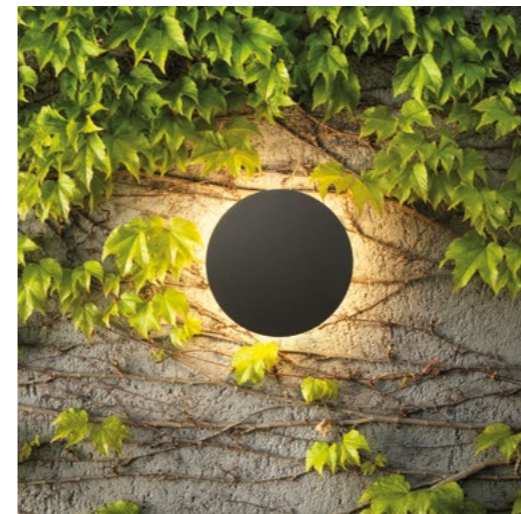



# T-LUX BOWLER



Effetti a parete / Wall effects

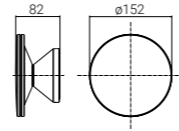

## T-LUX BOWLER Ø 150 mm



### Code

5558		AN - anthracite	27K - 2700K
		AG - aluminium grey	3K - 3000K
			4K - 4000K

Modulo LED a tensione di rete, compatibile con dimmer a taglio di fase /  
Mains voltage LED module, compatible with most phase-cut dimmers  
Compatibile con sagomatore / Compatible with beam limiter (code 5555)

Lamp	W	Lm LED	Real Lm	Optic
LED	10	1150	607	diffuse

### Su richiesta / On request



24V low voltage (code + 24V)

 BI - white  CO - corten  BR - bronze

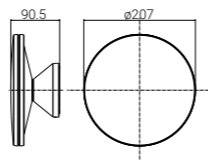
## T-LUX BOWLER Ø 200 mm



### Code

5559		AN - anthracite	27K - 2700K
		AG - aluminium grey	3K - 3000K
			4K - 4000K

Modulo LED a tensione di rete, compatibile con dimmer a taglio di fase /  
Mains voltage LED module, compatible with most phase-cut dimmers

Lamp	W	Lm LED	Real Lm	Optic
LED	20	2300	1360	diffuse

### Su richiesta / On request

24V low voltage (code + 24V)

 BI - white  CO - corten  BR - bronze





# CANTHARELLUS



Un classico elemento luminoso rivisitato in chiave contemporanea. Progettato per illuminare verso il basso, CANTHARELLUS si presta eccellentemente per vialetti, percorsi e spazi intimi nei giardini. Grazie ai LED studiati nel disco superiore l'efficienza luminosa è alta e ben ottimizzata per entrambe le dimensioni disponibili. CANTHARELLUS si abbina alle tre altezze del palo Goccia Illuminazione o come lampada da montare con raccordo su palo Ø 60 mm.

A classic lighting element revisited in a contemporary way. Designed to illuminate downwards, CANTHARELLUS is particularly suitable for gardens, paths and intimate spaces outdoors. Thanks to the LEDs studied in the upper disc, the luminous efficiency is high and well optimized for both available sizes. CANTHARELLUS can be combined with the three heights of the Goccia Illuminazione pole or as a lamp to be mounted with an adaptor on a Ø 60 mm pole.

## POLES



CANTHARELLUS  
Ø 150



CANTHARELLUS  
Ø 200



# CANTHARELLUS

## Coperchio convesso

La particolare forma del coperchio evita il ristagno dell'acqua.

## Rounded cover

This profile avoids water stagnation.

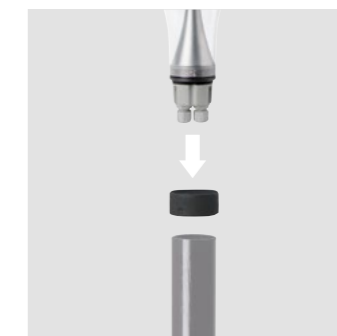
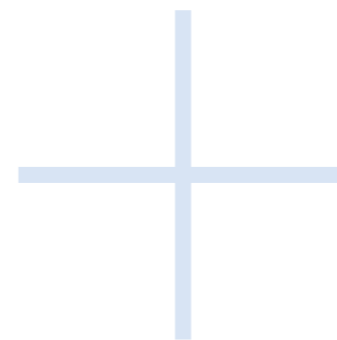

## Adattatore per pali Ø 60 mm

Gli apparecchi CANTHARELLUS possono essere installati e fissati mediante uno speciale raccordo anche su qualsiasi palo di mercato di Ø 60 mm.

## Adaptor for Ø 60 mm poles

CANTHARELLUS can be installed and fixed on any type of Ø 60 mm pole available on the market by a very simple adaptor.



## Distribuzione della luce

Il posizionamento della scheda LED consente di direzionare la luce verso il basso, riducendo al minimo la dispersione verso l'alto.

## Light distribution

The position of the LED module allows for directing the light downwards, minimising upward light dispersion.



## Struttura

Parte superiore e scocca in lega di alluminio primario a basso tenore di rame. Coppa di protezione in policarbonato trasparente satinato. Cono interno in alluminio antiriflesso.

## Structure

Upper part and body made of primary aluminium alloy with low copper content. Clear satin polycarbonate diffuser. Anti-glare aluminium internal cone.

Il corpo lampada è dotato di 2 pressacavi per consentire l'alimentazione passante.

The lamp body is provided with 2 cable glands for through wiring.

## Pali in alluminio

Pali lisci in alluminio estruso. Disponibili in 3 altezze: 375, 800 e 1875 mm. CANTHARELLUS Ø 150 è consigliato per installazione sui pali di altezza 375 mm; CANTHARELLUS Ø 200 per pali da 800 o 1875 mm.

## Aluminium poles

Extruded aluminium smooth poles. Three heights available: 375, 800 and 1875 mm. CANTHARELLUS Ø 150 version is recommended for 375 mm poles and the Ø 200 version for 800 or 1875 mm poles.

# CANTHARELLUS

Pali da giardino / Garden poles



## CORPO LAMPADA / LIGHT BODY Ø 150 mm

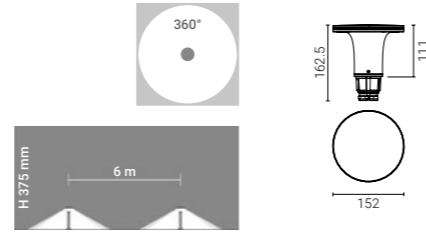

Code	
5521	● AN - anthracite
	27K - 2700K 3K - 3000K 4K - 4000K

Lamp	W	Lm LED	Real Lm	Optic
LED	10	1150	863	diffuse

Modulo LED a tensione di rete, compatibile con dimmer a taglio di fase / Mains voltage LED module, compatible with most phase-cut dimmers

**Su richiesta / On request**

24V low voltage (code + 24V)

● AG - aluminium grey ● CO - corten

## CORPO LAMPADA / LIGHT BODY Ø 200 mm

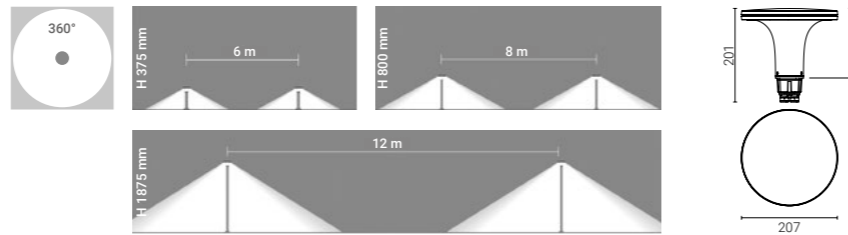

Code	
5522	● AN - anthracite
	27K - 2700K 3K - 3000K 4K - 4000K

Lamp	W	Lm LED	Real Lm	Optic
LED	20	2300	1849	diffuse

Modulo LED a tensione di rete, compatibile con dimmer a taglio di fase / Mains voltage LED module, compatible with most phase-cut dimmers

**Su richiesta / On request**

24V low voltage (code + 24V)

● AG - aluminium grey ● CO - corten

# CANTHARELLUS

Accessori / Accessories



## PALI / POLES



Code	
3421	● AN - anthracite
3422	
3423	

H	Description
375 mm	Palo liscio in alluminio estruso, comprensivo di base esterna in alluminio forgiato / Smooth pole in extruded aluminium with integrated external ground fixing base in forged aluminium
800 mm	
1875 mm	

**Su richiesta / On request**

● AG - aluminium grey ● CO - corten

## PIASTRA TIRAFONDI / PLATE WITH ANCHORING SET

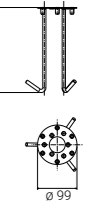

Code	Description
5519	Piastra inox con tirafondi per ancoraggio al terreno / Stainless steel plate with ground anchoring set

## RACCORDO PER PALI STANDARD / ADAPTOR FOR STANDARD POLES Ø 60 mm



Code	Description
5506	Raccordo in alluminio primario pressofuso, adattabile a qualsiasi palo Ø 60 mm / Adaptor in die-cast primary aluminium, to be installed on any pole Ø 60 mm







# CANTHUS



L'illuminazione cittadina di spazi aperti, come viali e parcheggi anche in un contesto privato, contribuisce alla loro vivibilità ed atmosfera - fondamentali risultano l'efficienza luminosa ed il comfort visivo.

Nata da un'intuizione per l'illuminazione residenziale, CANTHUS innalza l'eleganza, lo stile inconfondibile e la portata illuminante. Per esaltare la leggiadria delle forme nel contesto urbano, di un parco o della luce per grandi spazi, nel segno caratteristico della versatilità di installazione.

Un disegno di luce armonioso e forte.

Urban lighting of open spaces, such as avenues and parking lots, even in a private context, contributes to their livability and atmosphere - luminous efficiency and visual comfort are fundamental.

Inspired by an intuition for residential typologies, the new series CANTHUS raises the bar of elegance, unmistakable style and illuminating range. To exalt the elegance of shapes in an urban context, in a park, or lighting for large spaces, characterized by versatility of installation.

A harmonious and strong lighting design.

## URBAN LIGHTING

---



CANTHUS



# CANTHUS

## Struttura

Corpo illuminante Ø 360 mm in alluminio pressofuso a basso tenore di rame. Diffusore in policarbonato anti UV e schermo lenticolare opalizzato. Palo Goccia Illuminazione Ø 76 mm in acciaio zincato a caldo, elettrosaldato, con codolo Ø 60 mm.

## Structure

Ø 360 mm light fixture in low copper content die-cast aluminium. Anti UV polycarbonate diffuser and lenticular opal screen. Ø 76 mm Goccia Illuminazione pole in hot-dip galvanized steel, electro-welded, with Ø 60 mm top pole reduction.



## Cablaggio

Cablaggio facilitato alla portella grazie al cavo 2x1 lungo 2,30 m; secondo ingresso M16 disponibile per cablaggio aggiuntivo.

## Cabling

Easier cabling to cover panel thanks to the 2x1 cable, 2,30 m long; further pull down M16 entry for additional cabling.

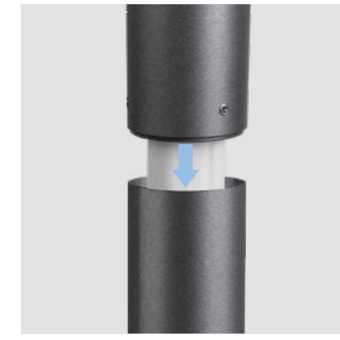
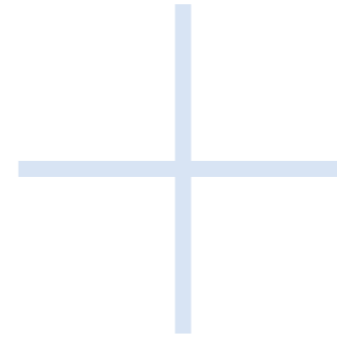

## Perfetto accoppiamento

Armonica combinazione della testa CANTHUS con il palo Goccia Illuminazione Ø 76 mm (con codolo Ø 60 mm) nella stessa finitura.

## Perfect coupling

Harmonious combination of CANTHUS top with Ø 76 mm Goccia Illuminazione pole (with Ø 60 mm top pole reduction) in the same finish.



## Schermo lenticolare

Appositamente progettato per garantire allo stesso tempo un elevato rendimento e il massimo comfort visivo.

## Lenticular screen

Especially designed to grant at the same time high efficiency and maximum visual comfort.



## Versatile adattabilità

Gli apparecchi CANTHUS possono essere installati su qualsiasi palo di mercato di Ø 60 mm.

## Versatile adaptability

CANTHUS can be installed on any type of Ø 60 mm pole available on the market.

# CANTHUS

Arredo urbano / Urban lighting



## CORPI LAMPADA / LIGHT BODIES

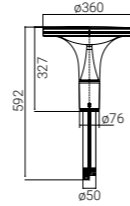

Code		Lamp	W	Lm LED	Real Lm	Optic
5523	● AN - anthracite	LED	29	4400	2420	diffuse
5524			43	6400	3658	

Forniti con 2,30 m di cavo / 2,30 m cable included

Installabili a sormonto anche su pali standard Ø 60 mm in alluminio / To be mounted through overlapping installation also on standard Ø 60 mm aluminium poles

Eventuale protettore di sovratensioni da ordinare separatamente / Optional SPD to be ordered separately (page 309)

**Su richiesta / On request**

Versione dimmerabile / Dimmable version

● AG - aluminium grey

## PALI INTERRABILI / BURIABLE POLES

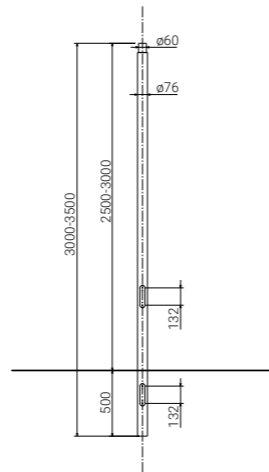

Code	H	Description
3504	3000 mm (2500 mm fuori terra / above ground)	Palo liscio in acciaio Ø 76 mm ricavato da tubo elettrosaldato, zincato a caldo e verniciato. Completo di foro ingresso cavi, attacco di messa a terra e asola con portella e morsetti. Codolo superiore di installazione Ø 60 mm / Smooth pole Ø 76 mm in steel obtained from electro-welded tube, hot-dip galvanized and painted. Complete with cable entry, earthing connection and slot with inspection door and terminal block. Top pole reduction Ø 60 mm
3505	3500 mm (3000 mm fuori terra / above ground)	

Eventuale protettore di sovratensioni installabile in portella (cod. 1966) da ordinare separatamente / Optional SPD installable inside the wiring box (code 1966) to be ordered separately

**Su richiesta / On request**

Versione con basamento / Version with base





# I-MAGO



Con il suo disegno unico e sapiente nelle proporzioni I-MAGO esalta la leggerezza e lo slancio delle forme accendendosi come una piccola cascata, una clessidra luminosa. L'esile stelo che si illumina in realtà supporta una scheda LED superiore capace di illuminare cospicuamente a terra in modo diretto, verso il basso, con un'apertura di diffusione di 120° e senza dispersione verso l'alto. Per inserirsi con discrezione ed eleganza nei giardini, presso i camminamenti, ai bordi degli spazi aperti, si compone con i pali in due diverse altezze in alluminio estruso o acciaio inossidabile.

With its unique design and skilful proportions, I-MAGO enhances the lightness and momentum of the shapes, lighting up like a small waterfall, a luminous hourglass. The slender stem that actually lights up supports an upper LED board capable of brightly illuminating the ground directly, downwards, with a diffusion angle of 120° and without upward dispersion. To fit with discretion and elegance in the gardens, near the walkways, at the edges of open spaces, it is composed with poles in two different heights in extruded aluminum or stainless steel.

## POLES



I-MAGO

# I-MAGO



## Struttura

Coppa in policarbonato trasparente stabilizzato anti UV. Parti interne in alluminio satinato. Corpo completo di scatola di cablaggio in tecnopolimero autoestinguente con anello di raccordo in alluminio verniciato o cromato.

## Structure

Transparent polycarbonate UV resistant stabilised diffuser. Internal parts in satin aluminium. Body complete with self-extinguishing technopolymer wiring box with painted aluminium or chrome connection ring.

## Pali

- lisci, in **alluminio estruso**, completi di base in alluminio forgiato. Disponibili in due differenti altezze. La finitura antracite anti-UV garantisce la completa tenuta nel tempo
- in **acciaio inox AISI 316L**, spazzolati e lucidati, destinati a resistere nel tempo anche negli ambienti maggiormente esposti a corrosione. La sezione poligonale è un personale design ottenuto da trafilatura

## Poles

- smooth, in **extruded aluminium** and base in forged aluminium. Available in two different heights. The finish anthracite makes I-LUX not invasive and ideal to be installed everywhere in the garden
- in **AISI 316L stainless steel**, brushed and polished, made to resist to the most corrosive environments. The original polygonal profile enhances the pole

Il corpo lampada è dotato di 2 pressacavi per consentire l'alimentazione passante.

The lamp body is provided with 2 cable glands for through wiring.

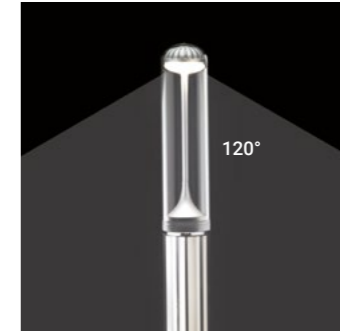
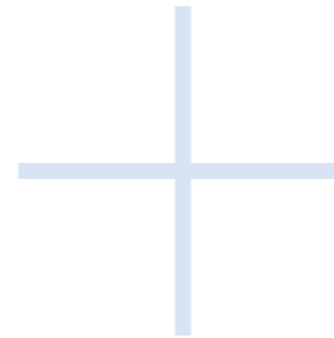

## Piccola cascata di luce

La luce è orientata verso il basso con un angolo di diffusione di 120°.

## Small waterfall of light

The light is directed downwards with an angle of diffusion of 120°.

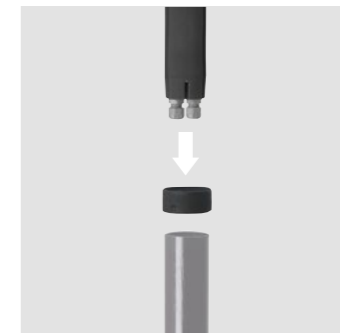

## Adattatore per pali Ø 60 mm

Gli apparecchi I-MAGO possono essere installati mediante uno speciale raccordo anche su qualsiasi palo di mercato di Ø 60 mm.

## Adaptor for Ø 60 mm poles

I-MAGO can be installed on any type of Ø 60 mm pole available on the market by a very simple adaptor.





# I-MAGO

Pali da giardino / Garden poles



## CORPI LAMPADA / LIGHT BODIES



aluminium



AISI 316L st. steel

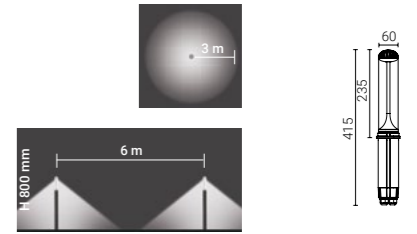

	Code	
5510	● AN - anthracite	3K - 3000K
5500	● IN - stainless steel	4K - 4000K

Material	Lamp	W	Lm LED	Real Lm	Optic
aluminium	LED	7,5	750	380	diffuse
AISI 316L st. steel					

Su richiesta / On request

10÷52V low voltage (code + LV)

## PALI / POLES



codes 3421 3422 AN



codes 3511 3512 IN

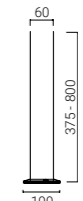

codes 3421 3422



codes 3511 3512

	Code	
3421	● AN - anthracite	
3422		
3511	● IN - stainless steel	
3512		

H	Description
375 mm	Palo liscio in alluminio estruso, comprensivo di base esterna in alluminio forgiato / Smooth pole in extruded aluminium with integrated external ground fixing base in forged aluminium
800 mm	
375 mm	Palo e base in acciaio inox AISI 316L, interamente spazzolato e lucidato / Pole and base in AISI 316L stainless steel, brushed and polished
800 mm	



# I-MAGO

Accessori / Accessories



## PICCHETTO / SPIKE

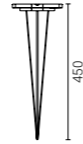

Code	Description
5505	Picchetto da giardino in tecnopolimero, listelli laterali di bloccaggio incorporati / Garden spike in technopolymer, side blocking bars incorporated

## PIASTRA TIRAFONDI / PLATE WITH ANCHORING SET

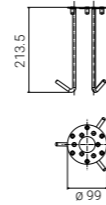

Code	Description
5519	Piastra inox con tirafondi per ancoraggio al terreno / Stainless steel plate with ground anchoring set

## RACCORDO PER PALI STANDARD / ADAPTOR FOR STANDARD POLES Ø 60 mm

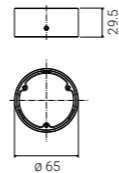

Code	Description
5506	Raccordo in alluminio primario pressofuso, adattabile a qualsiasi palo Ø 60 mm / Adaptor in die-cast primary aluminium, to be installed on any pole Ø 60 mm





# I-LUX



I-LUX di Goccia Illuminazione è una lampada da giardino stilizzata ed elegante che si inserisce perfettamente negli ambienti più raffinati. Realizzata per ospitare sorgenti luminose LED oppure lampade a risparmio energetico, è proposta nella versione trasparente con frangiluce interno direzionabile, oppure opale, per diffondere uniformemente la luce. Il sistema I-LUX consente l'abbinamento delle lampade con i pali standard Ø 60, ma si completa con i pali in alluminio e acciaio inox AISI 316L, o con i bracci dedicati per l'installazione a parete.

I-LUX by Goccia Illuminazione is a stylized and elegant garden lamp that fits perfectly into the most refined environments. Designed to house LED light sources or energy-saving lamps, it is proposed in the transparent version with internal directional louvre, or in the opal version, to spread the light evenly. The I-LUX system allows the lamps to be combined with standard Ø 60 poles, but is completed with poles in aluminum and AISI 316L stainless steel, or with dedicated arms for wall installation.

## POLES





# I-LUX

## Struttura

Coppa in policarbonato opale o trasparente stabilizzato anti UV. Corpo completo di scatola di cablaggio in tecnopolimero autoestinguente con anello di raccordo in alluminio o cromato.

## Structure

Opal or transparent polycarbonate UV resistant stabilised diffuser. Body complete with self-extinguishing technopolymer wiring box with aluminium or chrome connection ring.

Il corpo lampada è dotato di 2 pressacavi per consentire l'alimentazione passante.

The lamp body is provided with 2 cable glands for through wiring.

## Pali

- lisci, in **alluminio estruso**, completi di base in alluminio forgiato. Disponibili in due differenti altezze. La finitura antracite anti-UV garantisce la completa tenuta nel tempo
- in **acciaio inox AISI 316L**, spazzolati e lucidati, destinati a resistere nel tempo anche negli ambienti maggiormente esposti a corrosione. La sezione poligonale è un personale design ottenuto da trafilatura

## Poles

- smooth, in **extruded aluminium** and base in forged aluminium. Available in two different heights. The finish anthracite makes I-LUX not invasive and ideal to be installed everywhere in the garden
- in **AISI 316L stainless steel**, brushed and polished, made to resist to the most corrosive environments. The original polygonal profile enhances the pole

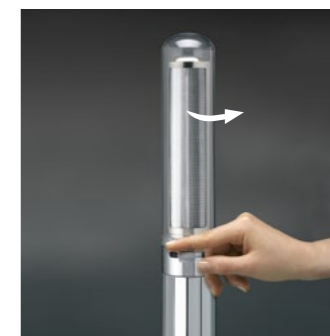
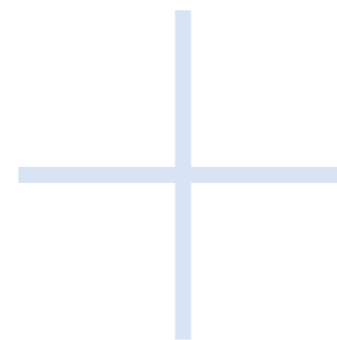

## Frangiluce orientabile con leva esterna

Il frangiluce interno è orientabile tramite leva esterna e consente di schermare la luce evitando l'abbagliamento.

## Adjustable anti-dazzling grid

The internal louvre can be adjusted using the outer lever to shield light to prevent glare.

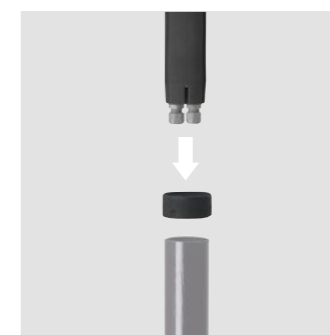

## Adattatore per pali Ø 60 mm

Gli apparecchi I-LUX possono essere installati mediante uno speciale raccordo anche su qualsiasi palo di mercato di Ø 60 mm.

## Adaptor for Ø 60 mm poles

I-LUX can be installed on any type of Ø 60 mm pole available on the market by a very simple adaptor.





CORPI LAMPADA OPALI / OPAL LIGHT BODIES



aluminium



AISI 316L st. steel

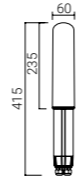

Code	
5517	● AN - anthracite 27K - 2700K 3K - 3000K
5540	● IN - stainless steel 4K - 4000K

Material	Lamp	W	Lm LED	Real Lm	Optic
aluminium	LED G23	9	930	600	diffuse
AISI 316L st. steel					

Coppa opale / Opal diffuser  
Forniti con lampadina LED / Supplied with LED lamp

CORPI LAMPADA TRASPARENTI CON FRANGILUCE / TRANSPARENT LIGHT BODIES WITH LOUVRE



aluminium



AISI 316L st. steel

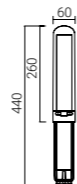

Code	
5502	● AN - anthracite
5504	● IN - stainless steel

Material	Lamp	W	Lm LED	Real Lm	Optic
aluminium	G23	11	-	-	diffuse
AISI 316L st. steel					

Coppa trasparente e frangiluce orientabile / Clear diffuser + adjustable antidazzling grid  
Forniti senza lampadina / Supplied without lamp



PALI / POLES



codes 3421 3422 AN

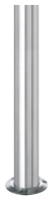

codes 3511 3512 IN



codes 3421 3422



codes 3511 3512

Code	H	Description
3421	375 mm	Palo liscio in alluminio estruso, comprensivo di base esterna in alluminio forgiato / Smooth pole in extruded aluminium with integrated external ground fixing base in forged aluminium
3422	800 mm	
3511	375 mm	Palo e base in acciaio inox AISI 316L, interamente spazzolato e lucidato / Pole and base in AISI 316L stainless steel, brushed and polished
3512	800 mm	

BRACCI / ARMS



code 5513 AN



code 5512 IN

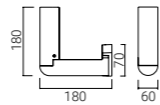

code 5513

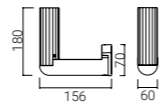

code 5512



code 5514 AN



code 5516 IN

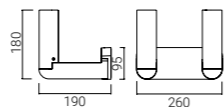

code 5514

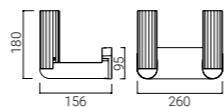

code 5516

Code	Description
5513	Braccio a muro singolo in alluminio / Single wall-arm in aluminium
5514	Braccio a muro doppio in alluminio / Double wall-arm in aluminium
5512	Braccio a muro singolo in inox AISI 316L / Single wall-arm in AISI 316L stainless steel
5516	Braccio a muro doppio in inox AISI 316L / Double wall-arm in AISI 316L stainless steel

PICCHETTO / SPIKE



Code

5505

Description

Picchetto da giardino in tecnopolimero, listelli laterali di bloccaggio incorporati / Garden spike in technopolymer, side blocking bars incorporated

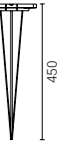

PIASTRA TIRAFONDI / PLATE WITH ANCHORING SET



Code

5519

Description

Piastra inox con tirafondi per ancoraggio al terreno / Stainless steel plate with ground anchoring set

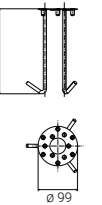

RACCORDO PER PALI STANDARD / ADAPTOR FOR STANDARD POLES Ø 60 mm



Code

5506

Description

Raccordo in alluminio primario pressofuso, adattabile a qualsiasi palo Ø 60 mm / Adaptor in die-cast primary aluminium, to be installed on any pole Ø 60 mm





# I-DEA



L'atmosfera raffinata e soffusa dell'abat-jour diventa l'ispirazione per I-DEA, la lampada per esterni che porta questa sensazione accogliente nei giardini e negli spazi all'aperto. Un fusto esile e robusto supporta il paraluce in policarbonato colorato, leggero ma con resistenza antivandalo, con i diversi colori accesi per caratterizzare l'ambiente. I-DEA è disponibile in due altezze differenti oppure per pali standard Ø 60, nelle sue versioni LED o a risparmio energetico. Nelle sua variante in vetro lavorato I-DEA PREZIOSA esalta la morbidezza della forma e della diffusione della luce, con i suoi delicati riflessi in un gioco di alternanza di chiaroscuri irripetibile, in tre diverse colorazioni.

The refined and suffused atmosphere of the abat-jour becomes the inspiration for I-DEA, the outdoor lamp that brings this welcoming feeling to gardens and outdoor spaces. A slim and sturdy frame supports the colored polycarbonate lampshade, light but with vandal-proof resistance, with the different bright colors to characterize the environment. I-DEA is available in two different heights or for standard Ø 60 poles, in its LED or energy saving versions. With the model in crafted glass, I-DEA PREZIOSA enhances the softness of shape and diffusion of light, with its delicate reflections in an alternating game of unrepeatable chiaroscuro, in three different colors.

## POLES



I-DEA



I-DEA  
PREZIOSA





Il corpo lampada è dotato di 2 pressacavi per consentire l'alimentazione passante.

The lamp body is provided with 2 cable glands for through wiring.

### Pali

Pali in alluminio estruso con piede in alluminio forgiato.

### Poles

Poles in extruded aluminium with forged aluminium base.

### Struttura

Il testa-palo è composto da due elementi:

- **paraluce** in policarbonato o in vetro lavorato a mano con paraluce interno bianco riflettente
- **corpo lampada** con raggiera in alluminio pressofuso, completo di scatola di cablaggio in tecnopolimero autoestinguente

### Structure

The pole head is composed by two parts:

- polycarbonate or hand-crafted glass **lampshade**. White internal lampshade for maximum downward light reflection
- **light body** with aluminium die-cast spokes, complete with self-extinguishing technopolymer wiring box

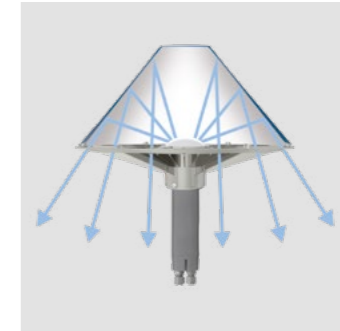
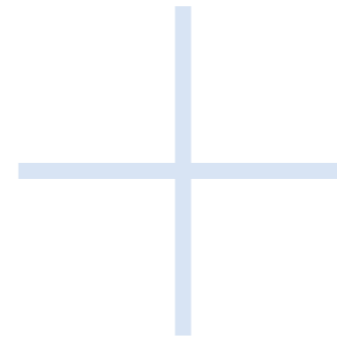

### Luce verso il basso

Paraluce con interno riflettente per irraggiare la luce verso il basso.

### Downward light

Lampshade with reflective inside to radiate light downwards.

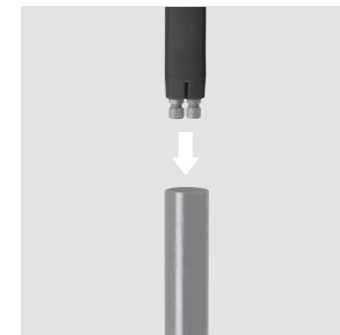

### Versatile adattabilità

Gli apparecchi I-DEA possono essere installati su qualsiasi palo di mercato di Ø 60 mm.

### Versatile adaptability

I-DEA can be installed on any type of Ø 60 mm pole available on the market.







CORPI LAMPADA / LIGHT BODIES

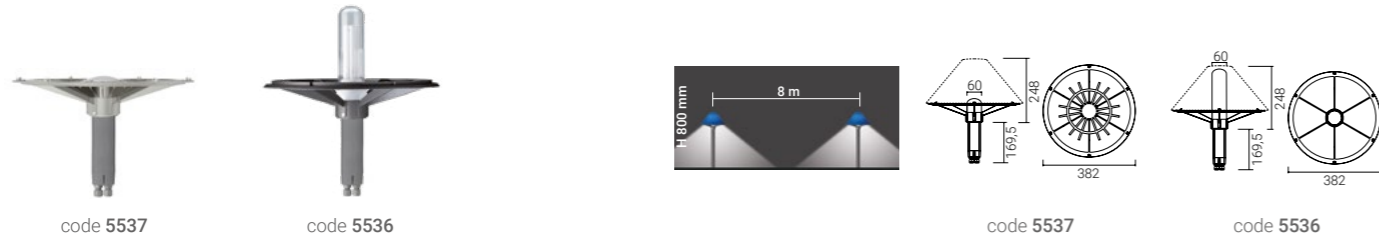

Code	Lamp	W	Lm LED	Real Lm	Optic	Class
5537	LED	10	1100	521	diffuse	I
5536	E27	33 max	-	-		II

Modulo LED a tensione di rete, compatibile con dimmer a taglio di fase / Mains voltage LED module, compatible with most phase-cut dimmers  
E27 Ø max 50 mm (fornito senza lampadina / supplied without lamp)

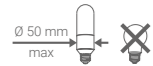

PARALUCI / LAMPSHADES



Code	Description
5531	Paraluce in policarbonato anti UV / Polycarbonate lampshade, UV resistant
5534	Paraluce in vetro lavorato con paraluce interno in policarbonato bianco / Crafted glass lampshade with internal lampshade in white polycarbonate



PALI / POLES



Code	H	Description
3421	375 mm	Palo liscio in alluminio estruso, comprensivo di base esterna in alluminio forgiato / Smooth pole in extruded aluminium with integrated external ground fixing base in forged aluminium
3422	800 mm	

PICCHETTO / SPIKE



Code	Description
5505	Picchetto da giardino in tecnopolimero, listelli laterali di bloccaggio incorporati / Garden spike in technopolymer, side blocking bars incorporated

PIASTRA TIRAFONDI / PLATE WITH ANCHORING SET



Code	Description
5519	Piastra inox con tirafondi per ancoraggio al terreno / Stainless steel plate with ground anchoring set

# WASH



Con geometria essenziale e raffinatezza dei dettagli WASH offre un'illuminazione wall washer precisa e di effetto. Le diverse dimensioni e le moderne forme squadrate o curve per l'installazione a parete consentono configurazioni con luce verso il basso, verso l'alto o in entrambe le direzioni. Il vetro a filo scocca del diffusore intensifica l'effetto luminoso del LED ad alta efficienza: opale, con luce morbida diffusa; trasparente ultrawhite, con luce diretta ed incisiva, con la possibilità di indirizzare il flusso luminoso verso la parete o verso l'esterno. Le diverse finiture proposte incontrano i diversi stili di inserimento ed esaltano la finezza delle linee.

With essential geometry and refinement of details, WASH offers precise and effective wall washer lighting. The different sizes and modern square or curved shapes for wall installation allow configurations with light downwards, upwards or in both directions. The glass diffuser flush with the body intensifies the lighting effect of the high-efficiency LED: opal, with soft diffused illumination; ultrawhite transparent, with direct and incisive lighting, with the possibility of directing the luminous flux towards the wall or towards the outside. The different finishes proposed meet the different styles of insertion and enhance the refinement of the lines.

## WALL EFFECTS



WASH 22  
opal



WASH 22  
asymmetric



WASH 42  
opal



WASH 24  
opal

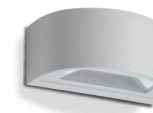

WASH 24  
asymmetric



WASH 52  
opal



# WASH

## Struttura

Diffusore a filo in vetro temprato, opale o trasparente ultrawhite. Corpo in alluminio pressofuso in lega marina a basso tenore di rame.

## Structure

Opal or ultrawhite clear tempered flush glass diffuser. Low copper content marine die-cast aluminium body.



Disponibile con doppia luce contrapposta e luce singola orientabile verso l'alto o verso il basso.

Available with double or single light that can be adjusted upwards or downwards.

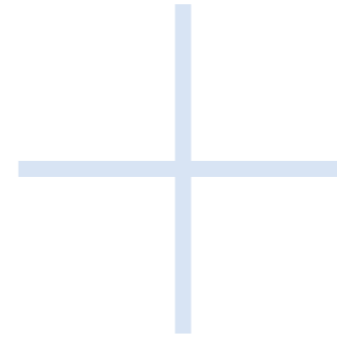

## Ottiche e vetri

Versione con modulo lineare LED e vetro opale per una luce diffusa e morbida. Versione LED COB con parabola asimmetrica riposizionabile e vetro trasparente ultrawhite per una luce diretta, nitida ed incisiva.

## Optics and glass

Version with LED linear module and opal glass for a soft and comfortable light. Version with COB LED, adjustable asymmetric reflectors and ultra-white clear glass for a direct, sharp and incisive light.



## Riposizionamento semplicissimo

La versione con vetri trasparenti è fornita con una o due parabole asimmetriche che possono essere individualmente riposizionate per orientare la luce verso la parete, accentuando l'effetto wall-washer, o verso l'esterno per illuminare i camminamenti.

La variazione della posizione delle parabole è semplice, agevole e può essere effettuata anche ad apparecchio installato. Sollevare la parabola e ruotarla di 180°, poi riposizionarla nella sua sede.

## Simple reflector adjustment

The asymmetric reflector can be individually fixed in two different positions: towards the wall to highlight the wall-washer effect or adjusted outwards to illuminate balconies, walkways, corridors, etc.

It is quite simple to adjust the reflector: adjustment can be made even if the light is on. Unscrew, lift the reflector, turn 180° and screw.

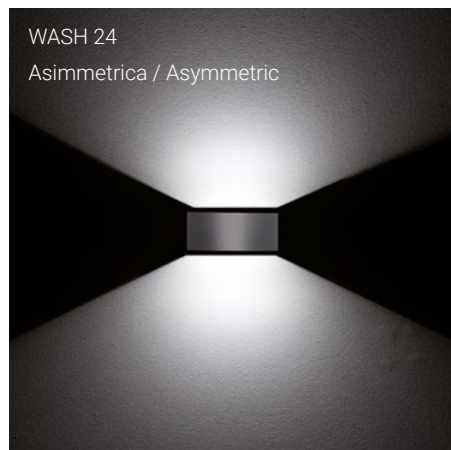
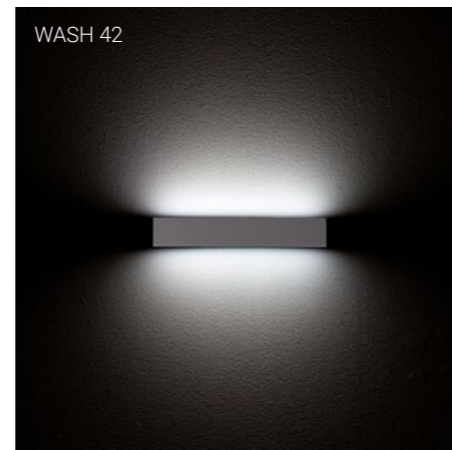
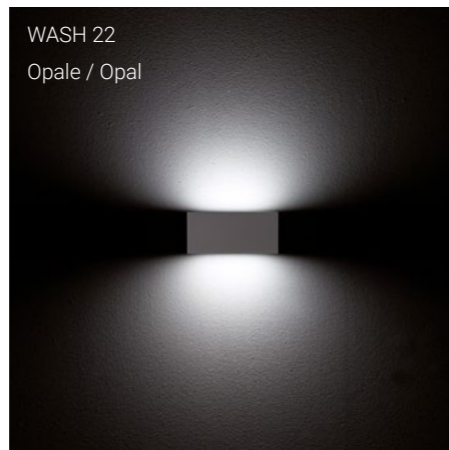
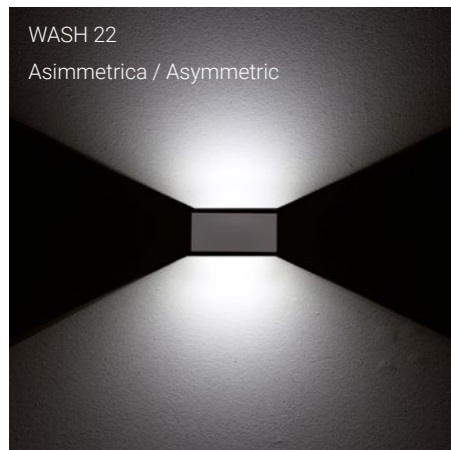

# WASH

Effetti a parete / Wall effects



## WASH 22 OPAL

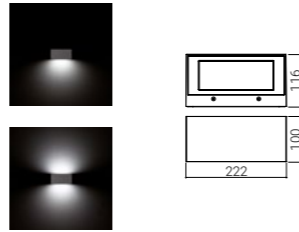

Code	
1305	● AN - anthracite ● 27K - 2700K ● 3K - 3000K ● 4K - 4000K
1301	● AG - aluminium grey
1306	○ BI - white
1302	● CO - corten

1305, 1301 Modulo lineare LED / Linear LED module  
E27 L max 176 mm (fornite senza lampadina / supplied without lamp)

Lamp	W	Lm LED	Real Lm	Optic
LED	1x9	1120	674	1 x diffuse
	2x9	2240	1348	2 x diffuse
E27	18	-	-	1 x diffuse
				2 x diffuse

**Su richiesta / On request**  
1305, 1301 Versione dimmerabile / Dimmable version  
1305, 1301 Versione emergenza / Emergency version

# WASH

Effetti a parete / Wall effects



## WASH 24 OPAL

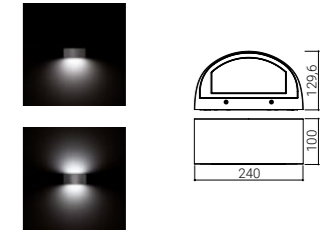

Code	
1324	● AN - anthracite ● 27K - 2700K ● 3K - 3000K ● 4K - 4000K
1321	● AG - aluminium grey
1325	○ BI - white
1322	● CO - corten

1324, 1321 Modulo lineare LED / Linear LED module  
E27 L max 176 mm (fornite senza lampadina / supplied without lamp)

Lamp	W	Lm LED	Real Lm	Optic
LED	1x9	1120	674	1 x diffuse
	2x9	2240	1348	2 x diffuse
E27	18	-	-	1 x diffuse
				2 x diffuse

**Su richiesta / On request**  
1324, 1321 Versione dimmerabile / Dimmable version  
1324, 1321 Versione emergenza / Emergency version

## WASH 22 ASYMMETRIC

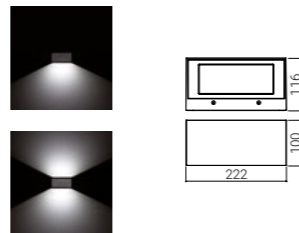

Code	
1309	● AN - anthracite ● 27K - 2700K ● 3K - 3000K ● 4K - 4000K
1308	● AG - aluminium grey
	○ BI - white
	● CO - corten

Vetro trasparente con parabola asimmetrica e LED COB /  
Ultra-white clear glass + asymmetric reflector + COB LED

Lamp	W	Lm LED	Real Lm	Optic
LED	1x11	1405	1150	1 x asym.
	2x11	2810	2300	2 x asym.

## WASH 24 ASYMMETRIC

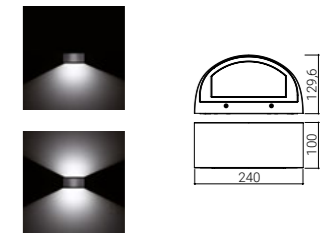
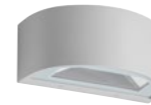

Code	
1328	● AN - anthracite ● 27K - 2700K ● 3K - 3000K ● 4K - 4000K
1327	● AG - aluminium grey
	○ BI - white
	● CO - corten

Vetro trasparente con parabola asimmetrica e LED COB /  
Ultra-white clear glass + asymmetric reflector + COB LED

Lamp	W	Lm LED	Real Lm	Optic
LED	1x11	1405	1150	1 x asym.
	2x11	2810	2300	2 x asym.



# WASH

Effetti a parete / Wall effects



## WASH 42 OPAL

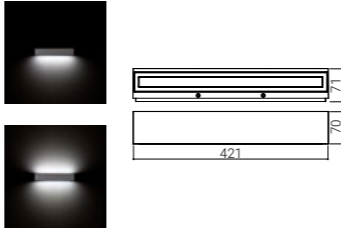

Code	
1312	<ul style="list-style-type: none"> <li><span style="display: inline-block; width: 10px; height: 10px; background-color: black; border-radius: 50%; margin-right: 5px;"></span> AN - anthracite</li> <li><span style="display: inline-block; width: 10px; height: 10px; background-color: grey; border-radius: 50%; margin-right: 5px;"></span> AG - aluminium grey</li> </ul>
	27K - 2700K 3K - 3000K 4K - 4000K
1311	<ul style="list-style-type: none"> <li><span style="display: inline-block; width: 10px; height: 10px; background-color: white; border-radius: 50%; border: 1px solid black; margin-right: 5px;"></span> BI - white</li> <li><span style="display: inline-block; width: 10px; height: 10px; background-color: brown; border-radius: 50%; margin-right: 5px;"></span> CO - corten</li> </ul>

Modulo lineare LED / Linear LED module

Lamp	W	Lm LED	Real Lm	Optic
LED	1x13	1629	977	1 x diffuse
	2x13	3258	1954	2 x diffuse

**Su richiesta / On request**

Versione dimmerabile / Dimmable version

Versione emergenza / Emergency version

## WASH 52 OPAL

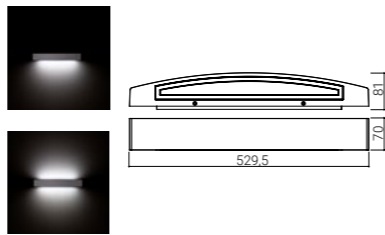

Code	
1333	<ul style="list-style-type: none"> <li><span style="display: inline-block; width: 10px; height: 10px; background-color: black; border-radius: 50%; margin-right: 5px;"></span> AN - anthracite</li> <li><span style="display: inline-block; width: 10px; height: 10px; background-color: grey; border-radius: 50%; margin-right: 5px;"></span> AG - aluminium grey</li> </ul>
	27K - 2700K 3K - 3000K 4K - 4000K
1332	<ul style="list-style-type: none"> <li><span style="display: inline-block; width: 10px; height: 10px; background-color: white; border-radius: 50%; border: 1px solid black; margin-right: 5px;"></span> BI - white</li> <li><span style="display: inline-block; width: 10px; height: 10px; background-color: brown; border-radius: 50%; margin-right: 5px;"></span> CO - corten</li> </ul>

Modulo lineare LED / Linear LED module

Lamp	W	Lm LED	Real Lm	Optic
LED	1x13	1629	977	1 x diffuse
	2x13	3258	1954	2 x diffuse

**Su richiesta / On request**

Versione dimmerabile / Dimmable version

Versione emergenza / Emergency version





K<sup>3</sup>



La forma elementare del cubo K<sup>3</sup> veste un'idea innovativa: disegnare con la luce. Potenze e ottiche specifiche per l'illuminazione di effetto a parete in mono-, bi- e quadriemissione. La costruzione in alluminio, in tre colori, si completa con vetri a filo cornice, garantendo un isolamento in Classe II e tenuta IP65.

K<sup>3</sup> MINILED, grazie alle dimensioni contenute, si inserisce elegantemente in spazi coperti o interni. All'esterno può sprigionare la sua potenza e definizione per creare effetti vivaci o per illuminare puntualmente i dettagli.

K<sup>3</sup> WRITER è lo strumento creativo illuminotecnico. Con la combinazione di lenti, sagomatori e filtri colorati enfatizza l'architettura di una facciata o porta un gioco di luce nuovo e originale.

K<sup>3</sup> POWER racchiude la massima potenza luminosa della serie. Grazie ad un accurato studio ottico delle parabole garantisce un rendimento luminoso molto elevato, per un'illuminazione in esterno di grande impatto e portata. Con i versatili accessori si arricchisce di orientabilità ed illuminazione di superficie.

The elementary shape of the K<sup>3</sup> cube contains an innovative idea: drawing with light. Specific powers and optics for single-, double- and four-emission wall effect lighting. The construction in aluminum, in three colors, is completed with glass flush with the frame, guaranteeing Class II insulation and IP65 rating.

K<sup>3</sup> MINILED, thanks to its small size, fits elegantly into covered or indoor spaces. Outdoors it can unleash its power and definition to create lively effects or to punctually illuminate details.

K<sup>3</sup> WRITER is the creative lighting tool. With the combination of lenses, profiles and colored filters, it emphasizes the architecture of a facade or brings a new and original play of light.

K<sup>3</sup> POWER contains the maximum luminous power of the series. Thanks to an accurate optical study of the parabolas, it guarantees a very high light output, for outdoor lighting of great impact and range. With the versatile accessories it is enriched with adjustability and surface lighting.

WALL EFFECTS



K<sup>3</sup> MINILED  
1 window



K<sup>3</sup> MINILED  
2 windows



K<sup>3</sup> MINILED  
4 windows



K<sup>3</sup> WRITER  
1 window



K<sup>3</sup> WRITER  
2 windows



K<sup>3</sup> WRITER  
4 windows



K<sup>3</sup> POWER  
1 window



K<sup>3</sup> POWER  
2 windows

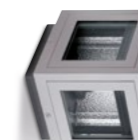

K<sup>3</sup> POWER  
4 windows



# K<sup>3</sup> MINILED

## Struttura

I diffusori in policarbonato sono a filo cornice onde evitare ristagni d'acqua. Corpo in alluminio pressofuso a basso tenore di rame. Viti inox a brugola in tinta. Ingresso cavi dal retro.

## Structure

The polycarbonate diffusers at frame level avoid stagnant water on the upper surface. Low copper content die-cast aluminium body. Matching stainless steel Allen screws. Rear cable entry.



## Fasci luminosi

K<sup>3</sup> MINILED è composta da 3 apparecchi:

- cubo con una finestra
- cubo con due finestre contrapposte
- cubo con quattro finestre

Il fascio luminoso è disponibile in due diverse angolazioni:

- stretto 30°
- diffuso 70°

## Beam angles

K<sup>3</sup> MINILED range consists of 3 fixtures:

- cube with one window
- cube with two opposite windows
- cube with 4 windows

Two beam angles available:

- narrow 30°
- wide 70°

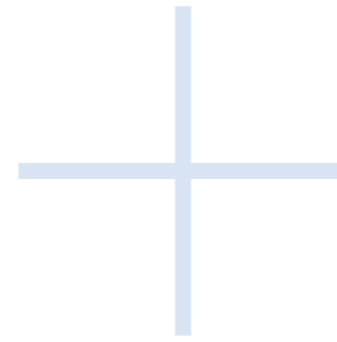
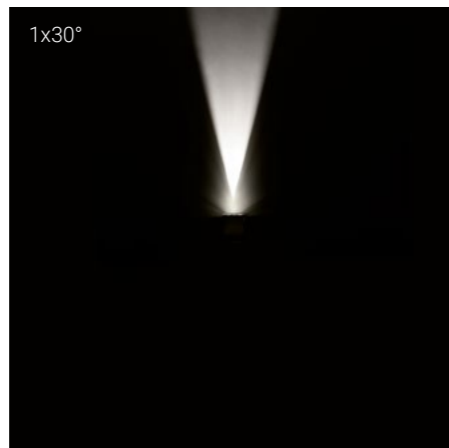

## Geometria della luce

La sorgente è orientata verso la parete per accentuare un nitido effetto geometrico. I sagomatori interni 30° e 70° permettono svariate combinazioni di luce.

## Geometry of the light

The LED source is directed toward the wall to accentuate a definite geometric effect. The 30° and 70° shapers allow different light combinations.

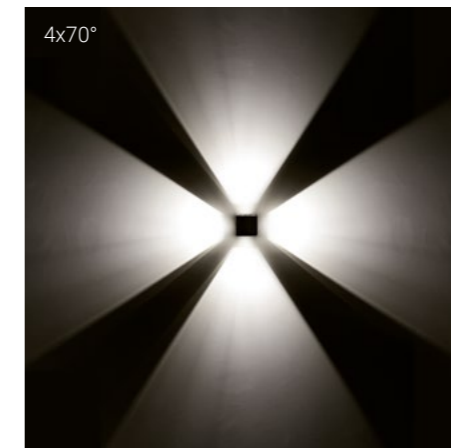
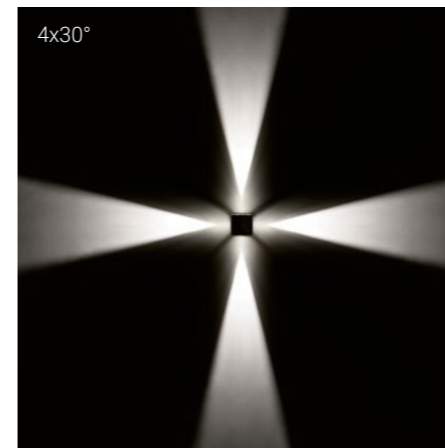
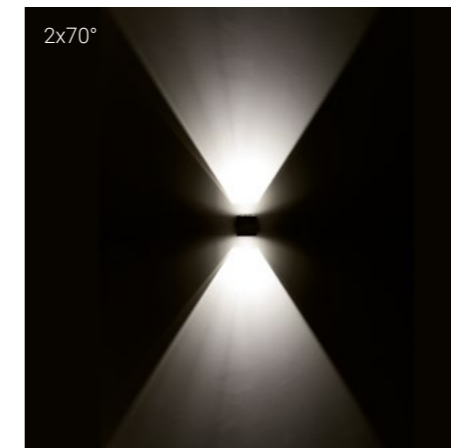
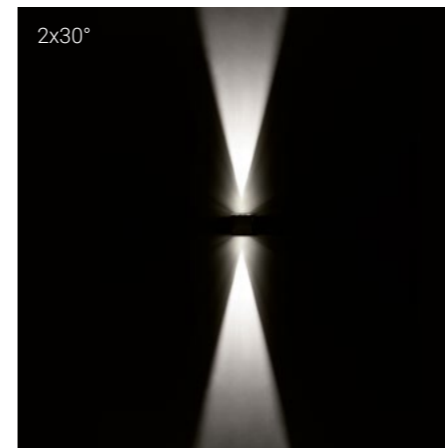

LAMPADE / LUMINAIRES



1 window

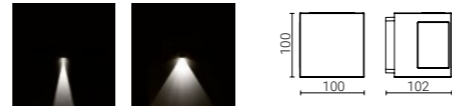

2 windows



4 windows



Code	
1040	
1041	
1042	● AN - anthracite
1043	● AG - aluminium grey
1044	○ BI - white
1045	
1046	

27K - 2700K  
3K - 3000K  
4K - 4000K

Lamp	W	Lm LED	Real Lm	Optic
LED	1x3	300	36	1x30°
			200	1x70°
	2x3	600	72	2x30°
			400	2x70°
			236	30°+70°
			144	4x30°
4x3	1200	800	4x70°	

Su richiesta / On request  
Ottica / Optic 15° (code + 15)  
● CO - corten

PICCHETTO / SPIKE

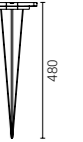

Code

1090

Description

Picchetto da giardino in tecnopolimero / Garden spike in technopolymer





# K<sup>3</sup> WRITER

## Struttura

Diffusore in vetro temprato ultrawhite e corpo in alluminio pressofuso a basso tenore di rame. Viti inox a brugola in tinta. Interno interamente nero opaco per evitare fastidiose riflessioni luminose. Ingresso cavi dal retro.

## Structure

Ultrawhite transparent tempered glass diffuser and low copper content die-cast aluminium body. Matching stainless steel Allen screws. Completely matt black inside to avoid any unwanted flare. Rear cable entry.



## Infinite combinazioni

Inserendo i 4 accessori si ottengono infinite combinazioni:

- due lenti concentratrici in vetro a 1 o 5 lame, progettate per ottenere effetti di alta intensità
- due schermi sagomati
- quattro filtri cromatici permettono di arricchire gli effetti luminosi con il colore

## Infinite combinations

The 4 accessories permit infinity combinations:

- two converging lenses in borosilicate glass for 1 or 5 blades designed to enhance its lighting effects
- two shapers
- four dichroic color filters

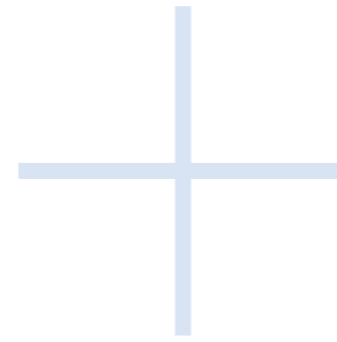
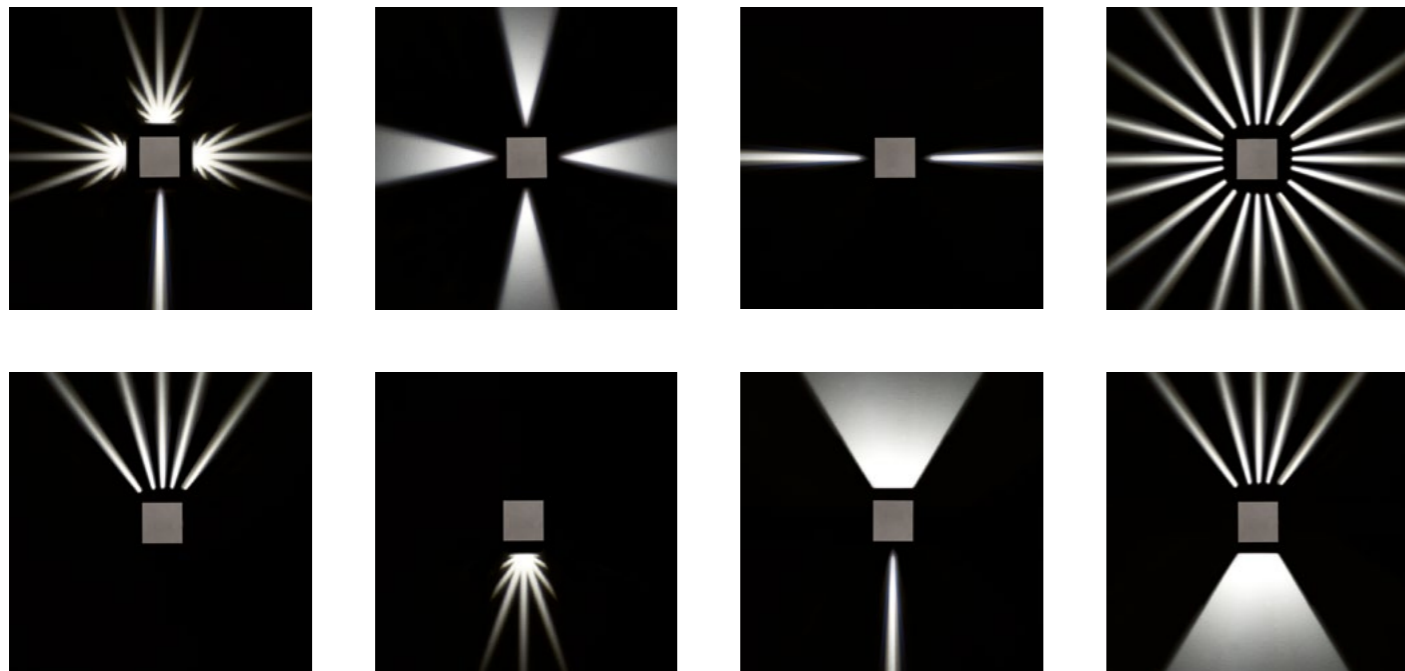

## Centraggio della focale

L'installazione delle lenti e dei sagomatori è semplicissima: le 4 viti su asola consentono il centraggio dell'accessorio e della sua focale.

## Centring focus

Lens and shapers can be easily inserted: 4 screws and its oval slots permit a complete and perfect focus regulation.



## Smontaggio semplificato

Lo smontaggio è semplificato ed è agevole anche con l'apparecchio installato, consentendo un successivo inserimento degli accessori in dotazione. L'interno è studiato per garantire la massima efficienza luminosa e il perfetto puntamento della luce.

## Easy disassembly

Assembling and maintenance are simple even if the fixture is already installed, allowing at any time to insert the accessories of the range. The inside has been studied to ensure maximum lighting efficiency and perfect light effects.

LAMPADE / LUMINAIRES



1 window



2 windows



4 windows

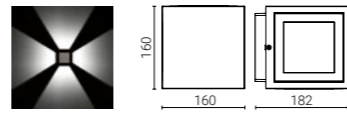
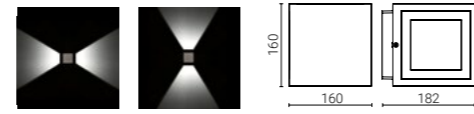
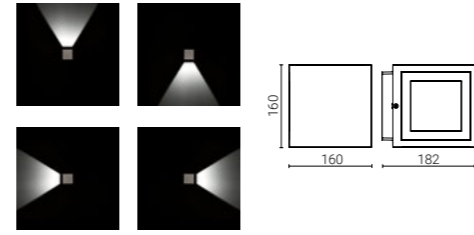

Code		
1004	● AN - anthracite	3K - 3000K 4K - 4000K
1008	● AG - aluminium grey	
1022	○ BI - white	

Lamp	W	Lm LED	Real Lm	Optic
LED	1x6,4	640	168	1x70°
	2x6,4	1280	336	2x70°
	4x6,4	2560	672	4x70°

Su richiesta / On request

Versione dimmerabile / Dimmable version

1022 Versione a 3 aperture / 3 windows version (code + 3F)



LENTI / LENSES

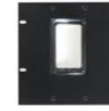

code 1091

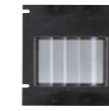

code 1092

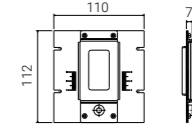

code 1091

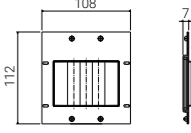

code 1092

Code

Description

1091

Lente convergente a 1 lama in vetro borosilicato purissimo, asole per centraggio della focale / Converging 1 blade lens in pure borosilicate glass, lateral slots for focus regulation

1092

Lente convergente a 5 lame in vetro borosilicato purissimo, asole per centraggio della focale / Converging 5 blades lens in pure borosilicate glass, lateral slots for focus regulation

SAGOMATORI / SHAPERS



code 1093



code 1095

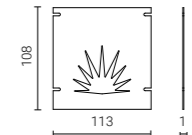

code 1093

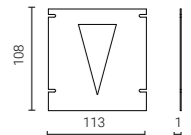

code 1095

Code

Description

1093

Sagomatore a foglia in acciaio / Steel leaf shaper

1095

Sagomatore 30° in acciaio / Steel 30° shaper

FILTRI COLORATI / DICHROIC FILTERS

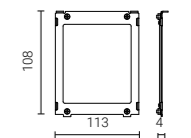

Code

Description

1096

- RO - red
- AR - orange
- VE - green
- BL - blue

Filtro colore con trattamento dicroico, vetro in borosilicato e telaio in acciaio nero / Filter with dichroic finish, color and glass amalgam system and black steel frame

1 filtro per 1 faccia / 1 filter for 1 window



# K<sup>3</sup> POWER

## Struttura

Diffusore in vetro temprato ultrawhite e corpo in alluminio pressofuso a basso tenore di rame. Viti a brugola in tinta. Ingresso cavi dal retro.

## Structure

Ultrawhite transparent tempered glass diffuser and low copper content die-cast aluminium body. Matching Allen screws. Rear cable entry.



## Efficienza luminosa

L'efficienza luminosa è assicurata da riflettori illuminotecnici in alluminio brillantato 99,8, appositamente progettati per ottimizzare la diffusione della luce.

## Lighting efficiency

The lighting efficiency is extremely high, thanks to parabolic Al 99,8 reflectors studied specifically for LED source.

## Fasci luminosi

K<sup>3</sup> POWER è composta da 3 apparecchi:

- cubo con una finestra
- cubo con due finestre contrapposte
- cubo con quattro finestre

Il fascio luminoso è disponibile in due diverse angolazioni:

- stretto 20°
- diffuso 50°

## Beam angles

K<sup>3</sup> POWER range consists of 3 fixtures:

- cube with one window
- cube with two opposite windows
- cube with 4 windows

Two beam angles available:

- narrow 20°
- wide 50°

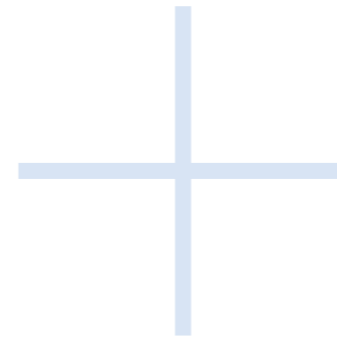
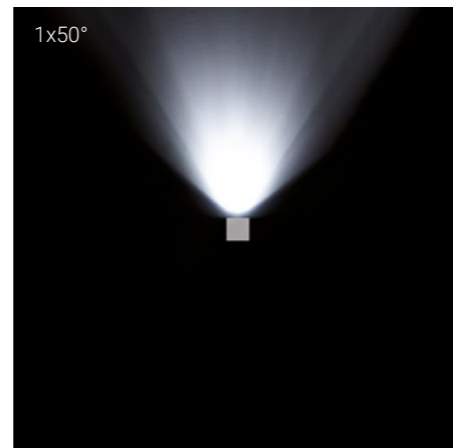
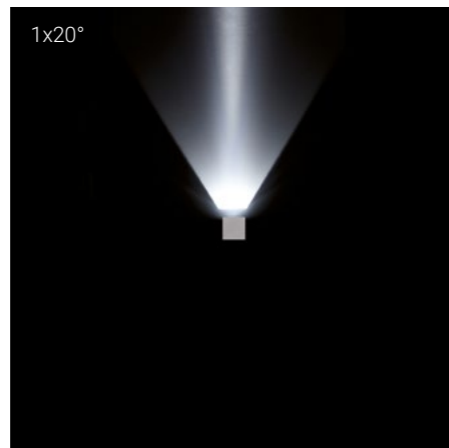

## Elevate prestazioni

Il dissipatore alettato dedicato consente superiori wattaggi. Mediante l'utilizzo della staffa snodo orientabile K<sup>3</sup> POWER diventa uno spot di potenza.

## High performances

The dedicated louvered heat sink allows higher wattages. Thanks to the orientable articulated bracket K<sup>3</sup> POWER becomes a high performing spot.

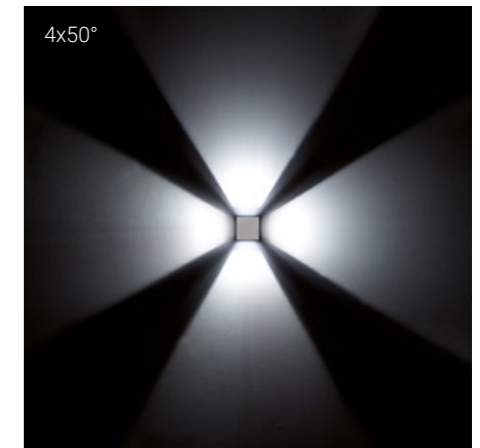
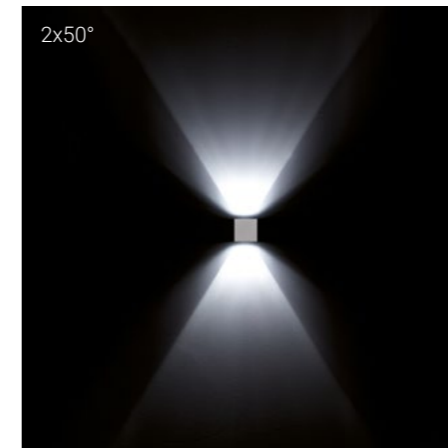
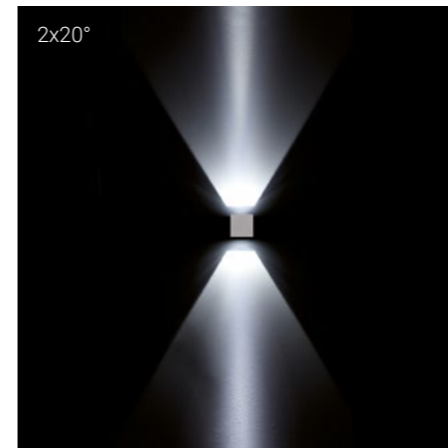

LAMPADE / LUMINAIRES



1 window



2 windows



4 windows

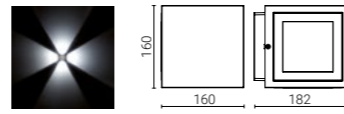
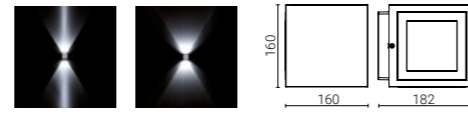
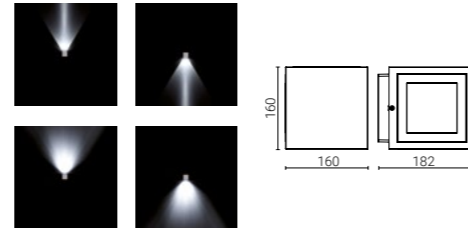

Code	Lamp	W	Lm LED	Real Lm	Optic
1102	LED	1x11	1405	1060	1x20°
1141		1x18	2761	1900	
1105		1x11	1405	927	1x50°
1142		1x18	2761	1690	
1106	E27	75	-	-	2x20°
1109	LED	2x11	2810	2120	
1146		2x18	5522	3800	
1122		2x11	2810	1854	
1147	LED	2x18	5522	3380	2x50°
1123		E27	75	-	-
1128	E27	75	-	-	4x50°

Versione RGBW (vedi capitolo dedicato) / RGBW version (see related chapter)  
E27 L max 128 mm (fornite senza lampadina / supplied without lamp)

Su richiesta / On request  
Versione dimmerabile / Dimmable version

STAFFA A SNODO / ARTICULATED BRACKET

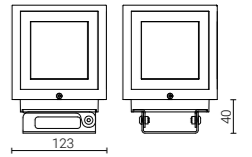

Code

Description

1191

Staffa a snodo, rotazione max 90° / Articulated bracket, max rotation 90°

PICCHETTO / SPIKE

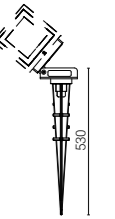

Code

Description

1192

Picchetto da giardino in tecnopolimero con staffa a snodo max 90° / Garden spike in technopolymer with articulated bracket max 90°

PIASTRA CON TIRAFONDI / PLATE WITH ANCHORING SET

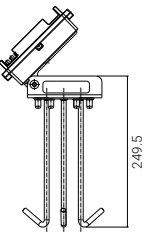

Code

Description

1193

Piastra da interrare con tirafondi e staffa a snodo max 90° / Plate with anchoring set and articulated bracket max 90°

GRIGLIA ANTIABBAGLIANTE / ANTI-GLARE FLANGED LOUVRE

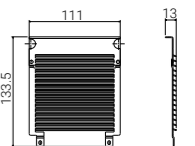

Code

Description

1194

Griglia in ferro antiabbagliante / Anti-glare flanged louvre

Da installare internamente / To be installed inside



APPARECCHI DA  
PARETE O SOFFITTO

WALL OR CEILING  
FITTINGS

# SMALL, MIDI, MAXI & SUPERMAXI



Questa serie di lampade dal design essenziale è impostata su una sezione triangolare in alluminio estruso, completata con cornice in alluminio pressofuso e tappi laterali in policarbonato. Si articola in quattro modelli con diverse lunghezze.

Le versioni SMALL, MIDI e MAXI sono proposte con diffusore in vetro ultrawhite con l'opzione griglia antiabbagliante, con lampade a basso consumo o LED ad alta efficienza. La versione SUPERMAXI nelle tre lunghezze, in Classe II, monta performanti sorgenti LED ed è stata accuratamente sviluppata con i suoi accessori per le applicazioni lineari in fila continua ed alternata. Una soluzione di grande efficacia negli spazi esterni, pubblici e privati, sviluppati in lunghezza, che si completa con le funzionalità Corridor per il risparmio energetico con i sensori di rilevamento di presenza.

This series of lamps with an essential design is set on a triangular section in extruded aluminum, completed with a die-cast aluminum frame and polycarbonate side caps. It is divided into four models with different lengths. The SMALL, MIDI and MAXI versions are offered with an ultrawhite glass diffuser with an anti-glare guard option, with low-consumption lamps or high-efficiency LEDs. The SUPERMAXI version in the three lengths, in Class II, is equipped with high-performance LED sources and has been carefully developed with its accessories for linear applications in continuous and alternating lines. A highly effective solution in outdoor spaces, public and private, developed in length, which is completed with the Corridor functions for energy saving with PIR sensors.

## WALL OR CEILING FITTINGS



SMALL



MIDI



MAXI



SUPERMAXI

## SMALL, MIDI, MAXI & SUPERMAXI



### Diffusore

Diffusore opale in vetro temprato ultrawhite per SMALL, MIDI e MAXI; in policarbonato anti UV per SUPERMAXI. Il diffusore in policarbonato opale consente la distribuzione uniforme della luce.

### Diffuser

Opal ultrawhite tempered glass diffuser for SMALL, MIDI and MAXI; opal UV resistant polycarbonate diffuser for SUPERMAXI. The polycarbonate diffuser emanates a wide and uniform light diffusion.



### Griglia in alluminio

La griglia in alluminio pressofuso con diffusore in vetro temperato, disponibile per le serie SMALL, MIDI e MAXI, è un efficace filtro antiabbagliante, senza compromettere la portata luminosa.

### Aluminium guard

The die-cast aluminium guard, available for SMALL, MIDI and MAXI, is an efficient antidazzling filter, maintaining anyway the complete light emission.



### SUPERMAXI "Corridor"

La funzione Corridor consente di ottimizzare l'illuminazione, grazie al circuito con rilevatore di presenza. 10% in stato di quiete con accensione automatica al 100% al passaggio.

### SUPERMAXI "Corridor"

The Corridor function allows to optimize the illumination thanks to a PIR sensor circuit. 10% at rest mode and 100% upon detection.

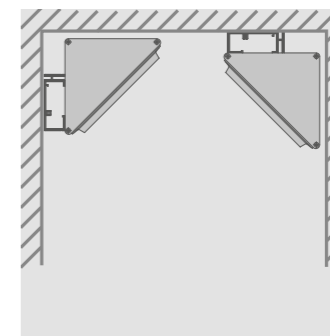

### Installazione a parete e a soffitto

Con il sistema di installazione a canale è possibile posizionare le lampade a parete o a soffitto, anche ad angolo.

### Wall and ceiling installation

Cable trunking installation makes it possible to position lamps on walls or ceilings, including in corners.



### Installazione a canale

Il canale di 3,2 m consente di installare facilmente linee di lampade SUPERMAXI. Due staffette permettono di agganciarle al canale con un semplice gesto consentendo il posizionamento di precisione e il perfetto allineamento.

### Cable trunking installation

The 3,2 m cable trunking allows for easy installation of SUPERMAXI lamp lines. Two brackets allows you to easily attach the cable trunking, permitting precision positioning and perfect alignment.



## SMALL & MIDI

Da parete o soffitto / Wall or ceiling



### SMALL



codes 5608 5606

codes 5609 5607

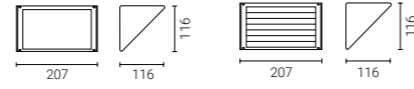

codes 5608 5606

codes 5609 5607

Code	Lamp	W	Lm LED	Real Lm	Optic	Class	IK
5608	LED	8,5	850	419	diffuse	II	08
5606	E 27	60	-	-	-	I	
5609	LED	8,5	850	419	diffuse	II	10
5607	E 27	60	-	-	-	I	

Diffusore opale in vetro temprato ultrawhite / Opal diffuser in ultra-white glass  
E 27 L max 130 mm (fornite senza lampadina / supplied without lamp)

[Su richiesta / On request](#)

5608, 5609 24V low voltage (code + 24V)

## MAXI & SUPERMAXI

Da parete o soffitto / Wall or ceiling



### MAXI



codes 5638 4450

codes 5635 4455

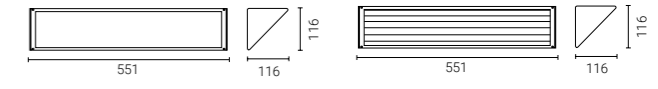

codes 5638 4450

codes 5635 4455

Code	Lamp	W	Lm LED	Real Lm	Optic	Class	IK
5638	LED	34	3400	1677	diffuse	II	08
4450	LED 3h emergency		3400/500	1677/247		I	
5635	LED		3400	1677		II	10
4455	LED 3h emergency		3400/500	1677/247		I	

Diffusore opale in vetro temprato ultrawhite / Opal diffuser in ultra-white glass

[Su richiesta / On request](#)

Diffusore in policarbonato antivandalo / Vandalproof polycarbonate diffuser (code + PC)

Versione dimmerabile / Dimmable version

24V low voltage (code + 24V)

### MIDI



code 5621

code 5622



code 5621

code 5622

Code	Lamp	W	Lm LED	Real Lm	Optic	Class	IK
5621	LED	17	1700	838	diffuse	II	08
5622							10

Diffusore opale in vetro temprato ultrawhite / Opal diffuser in ultra-white glass

[Su richiesta / On request](#)

Diffusore in policarbonato antivandalo / Vandalproof polycarbonate diffuser (code + PC)

24V low voltage (code + 24V)

### SUPERMAXI

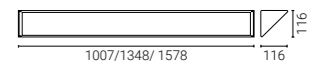

Code	L	Lamp	W	Lm LED	Real Lm	Optic
5212	1007 mm	LED	20	2000	1192	diffuse
5213			40	4000	2138	
5221	1348 mm		29	2850	1682	
5223			58	5650	3132	
5232	1578 mm	34	3400	2039		
5233		69	6800	3727		

Diffusore opale in policarbonato / Opal diffuser in polycarbonate

[Su richiesta / On request](#)

Versione dimmerabile / Dimmable version

24V low voltage (code + 24V)

Versione emergenza / Emergency version

# SUPERMAXI CORRIDOR

Funzione Corridor / Corridor function



La Serie SUPERMAXI si completa con la funzione Corridor che consente una gestione intelligente della luce. Grazie al particolare circuito incorporato, dotato di rilevatore di presenza, in condizioni di riposo la lampada emette il 10% di luminosità. Se una persona o un veicolo entrano nel campo del sensore la lampada viene automaticamente riportata alla massima luminosità per un tempo regolabile. Altri settaggi su richiesta. Oltre alla lampada SUPERMAXI è previsto anche un modulo cieco da inserire lungo la linea.

SUPERMAXI enlarges its range with the Corridor function to allow a smart light control. Thanks to a PIR sensor compatible with the incorporated control gear, the luminaires dim down to 10%, but upon detection they will light up to 100% for a pre-set period of time. Other settings available upon request. Blind modules can be inserted between continuous SUPERMAXI lines.

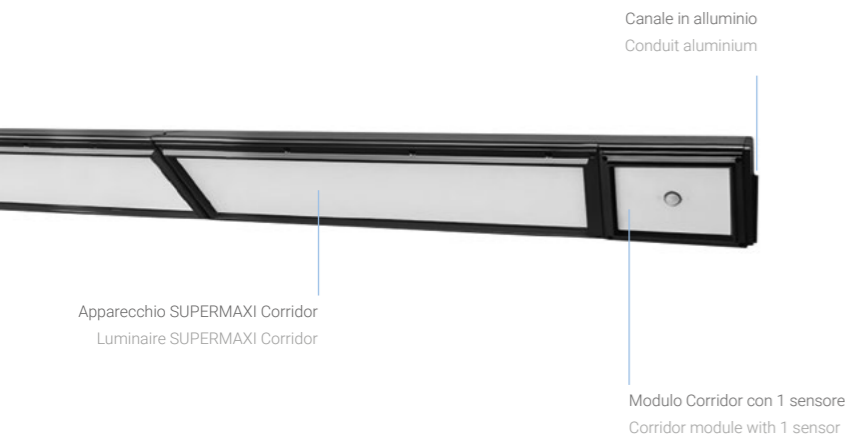

## MODULI CORRIDOR / CORRIDOR MODULES



code 5700

code 5704

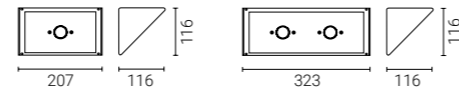

code 5700

code 5704

Code	Description
5700 ● NE - black	Modulo Corridor con 1 sensore / Corridor module with 1 sensor
5704 ● AG - aluminium grey	Modulo Corridor con 2 sensori / Corridor module with 2 sensors

Corpo e cornice in alluminio, diffusore e tappi laterali in policarbonato / Housing and frame in aluminium, diffuser and side covers in polycarbonate

Gli apparecchi SUPERMAXI abbinati devono riportare la sigla COR a lato del codice (Richiedere sovrapprezzo) / Add "COR" to the code of combined SUPERMAXI fittings (Ask for surcharge)

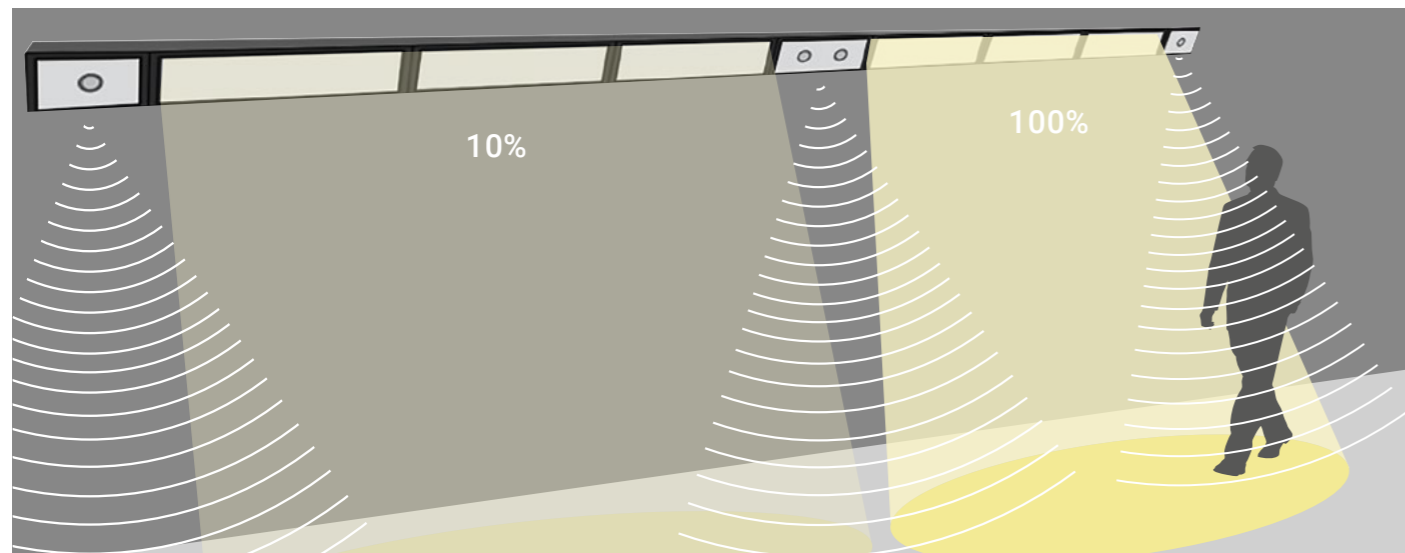

# SUPERMAXI

Sistema installazione a canale / Cable trunking installation system



## SISTEMA PORTACAVI / CABLE TRUNKING SYSTEM

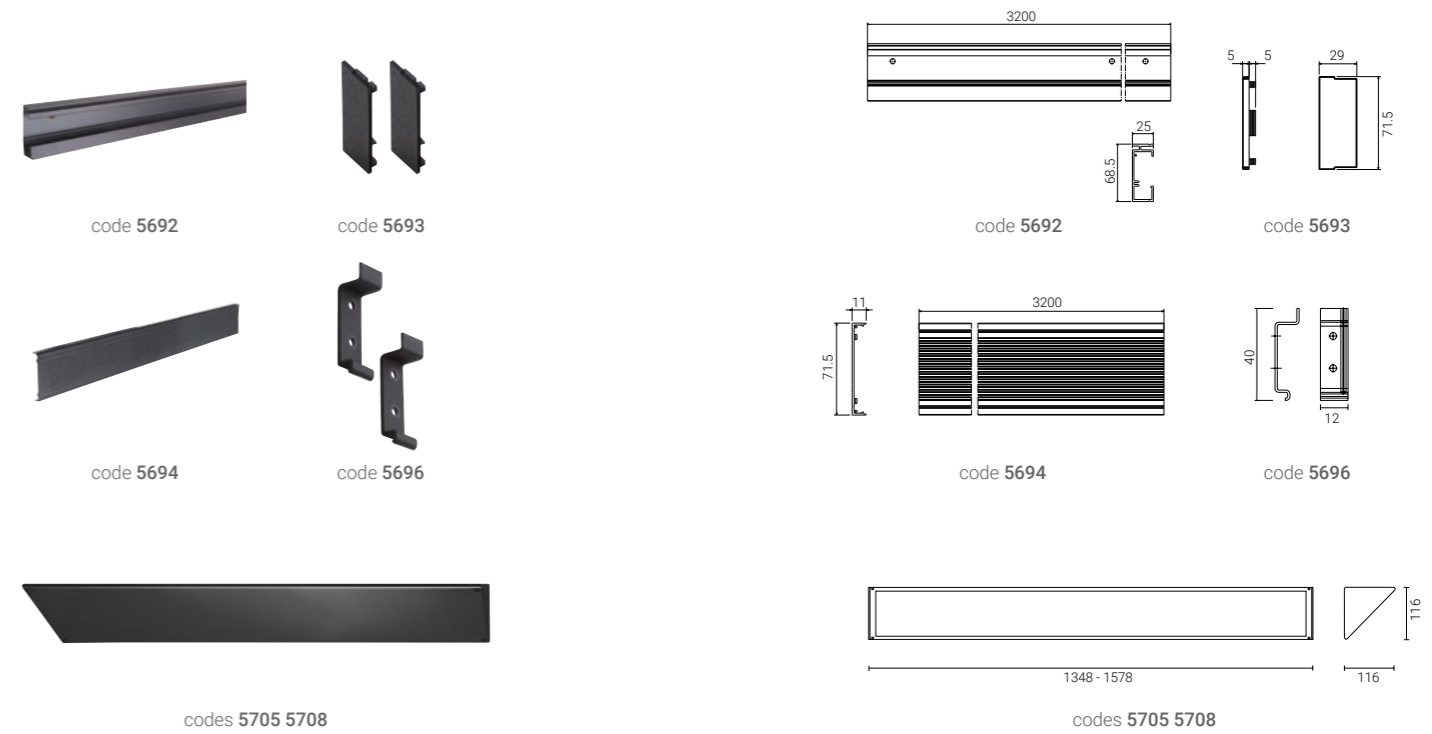

Code	Description
5692	Canale portacavi in alluminio, comprensivo di 3 scatole di derivazione / Aluminium cable trunking, each module contains 3 connections
5693	Tappo laterale unico: sia destro che sinistro / Side cover: one only type for right and left side
5694	Coperchio a incastro in tecnopolimero / Technopolymer snapping cover
5696 ● NE - black	Coppia staffe in acciaio per predisporre SUPERMAXI all'aggancio sul canale / Brackets pair to handle SUPERMAXI to the conduit
5705	Modulo cieco L 1348 mm. Stesso corpo in alluminio e tappi laterali di SUPERMAXI. Coperchio in acciaio / Blind module L 1348 mm. Same aluminium housing and side covers of SUPERMAXI. Steel cover
5708	Modulo cieco L 1578 mm. Stesso corpo in alluminio e tappi laterali di SUPERMAXI. Coperchio in acciaio / Blind module L 1578 mm. Same aluminium housing and side covers of SUPERMAXI. Steel cover



# SMALL, MIDI, MAXI & SUPERMAXI

Accessori / Accessories

## BRACCI SNODATI / ADJUSTABLE ARMS

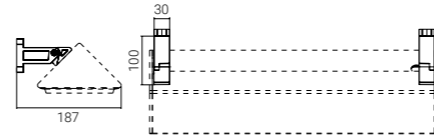

### Code

5080	<span style="display: inline-block; width: 10px; height: 10px; background-color: black; border-radius: 50%;"></span> NE - black
	<span style="display: inline-block; width: 10px; height: 10px; background-color: grey; border-radius: 50%;"></span> AG - aluminium grey

### Description

Coppia di bracci snodati in alluminio / Aluminium adjustable arms pair

Rotazione consentita / Rotation allowed  $\pm 30^\circ$

Per evitare ristagni d'acqua è sconsigliato l'orientamento verso l'alto / To avoid water stagnation, an upward orientation is not recommended

## STAFFA A SCATTO / SNAP BRACKET

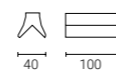

### Code

5091	<span style="display: inline-block; width: 10px; height: 10px; background-color: black; border-radius: 50%;"></span> NE - black
	<span style="display: inline-block; width: 10px; height: 10px; background-color: grey; border-radius: 50%;"></span> AG - aluminium grey

### Description

Staffa a scatto per fissaggio a plafone / Snap bracket for ceiling fixing

MIDI, MAXI 1 staffa / 1 bracket only  
SUPERMAXI 2 staffe / 2 brackets

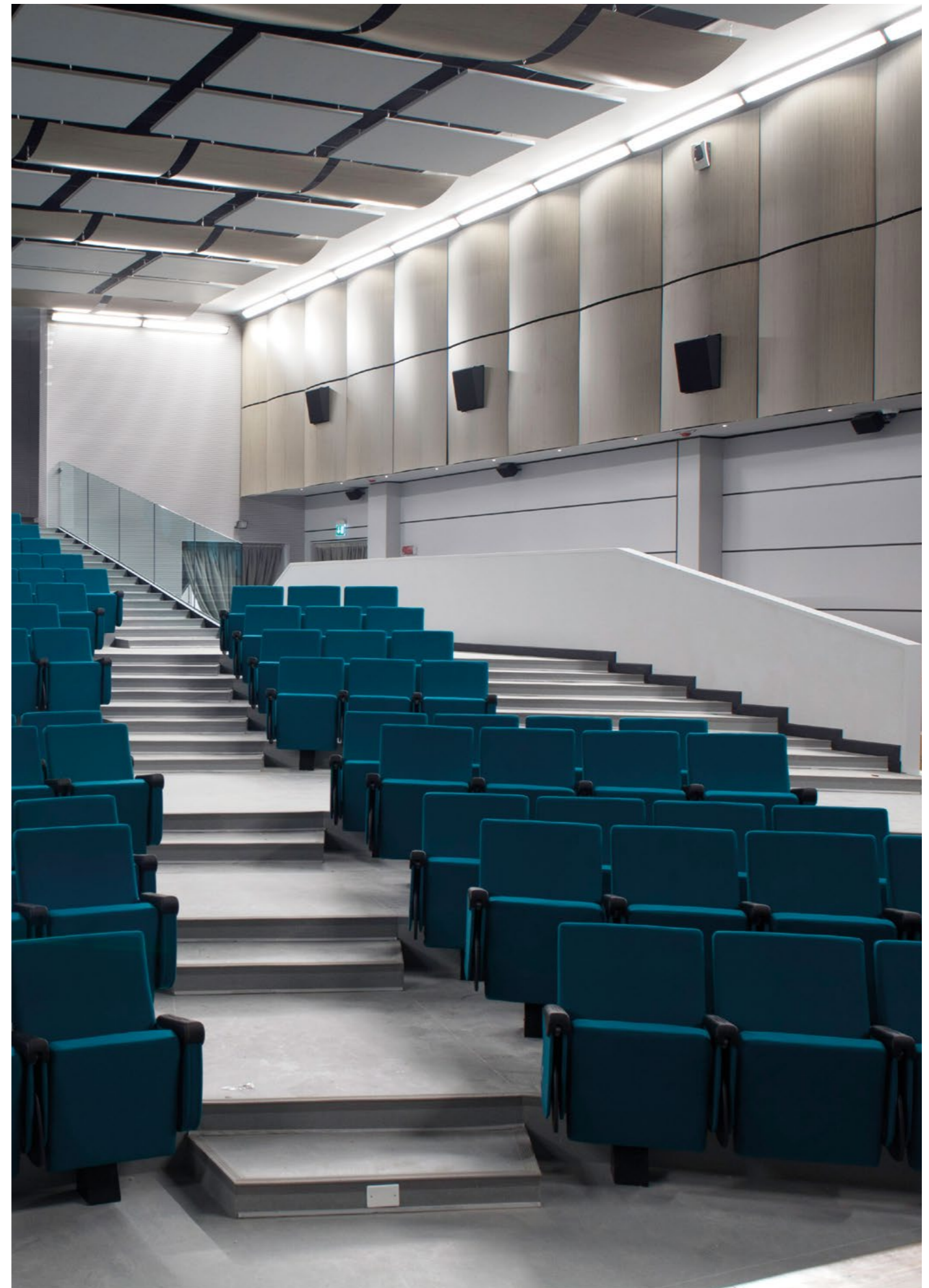

# TRIANGOLO



Da tempo TRIANGOLO è un classico intramontabile di Goccia Illuminazione. L'essenziale forma triangolare ha consentito a questa serie eclettica di rimanere sempre attuale e di evolversi in ulteriori applicazioni. Gli apparecchi TRIANGOLO sono disponibili in due dimensioni: piccola in policarbonato e grande in alluminio pressofuso. Le più recenti versioni LED sono state progettate per ottenere grandi prestazioni illuminanti attraverso una cospicua dissipazione del calore e la distribuzione della luce ottimizzata con i nuovi riflettori, fino alla evoluzione più performante e potente con ottiche dedicate - STRADA.

TRIANGOLO has long been a timeless classic of Goccia Illuminazione. The essential triangular shape has allowed this eclectic series to always remain modern and to evolve in further applications. TRIANGOLO luminaires are available in two sizes: small in polycarbonate and large in die-cast aluminum. The most recent LED versions have been designed to achieve great lighting performance through conspicuous heat dissipation and optimized light distribution with the new reflectors, up to the most performing and powerful evolution with dedicated optics - STRADA.

## WALL FITTINGS AND POSTS



TRIANGOLO  
opal

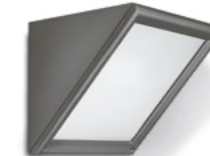

TRIANGOLO  
opal



TRIANGOLO  
transparent



# TRIANGOLO

## Struttura versione LED opale

Diffusore opale in vetro temprato ultrawhite.  
TRIANGOLO grande: corpo e cornice fermavetro in alluminio pressofuso a basso tenore di rame.  
TRIANGOLO piccolo: corpo e cornice fermavetro in policarbonato.  
Ingresso cavi dal retro.

## Structure opal LED version

Opal diffuser in tempered ultrawhite glass.  
Large TRIANGOLO: body and glazing bead frame in die-cast aluminium with low copper content.  
Small TRIANGOLO: body and glazing bead frame in polycarbonate.  
Rear cable entry.

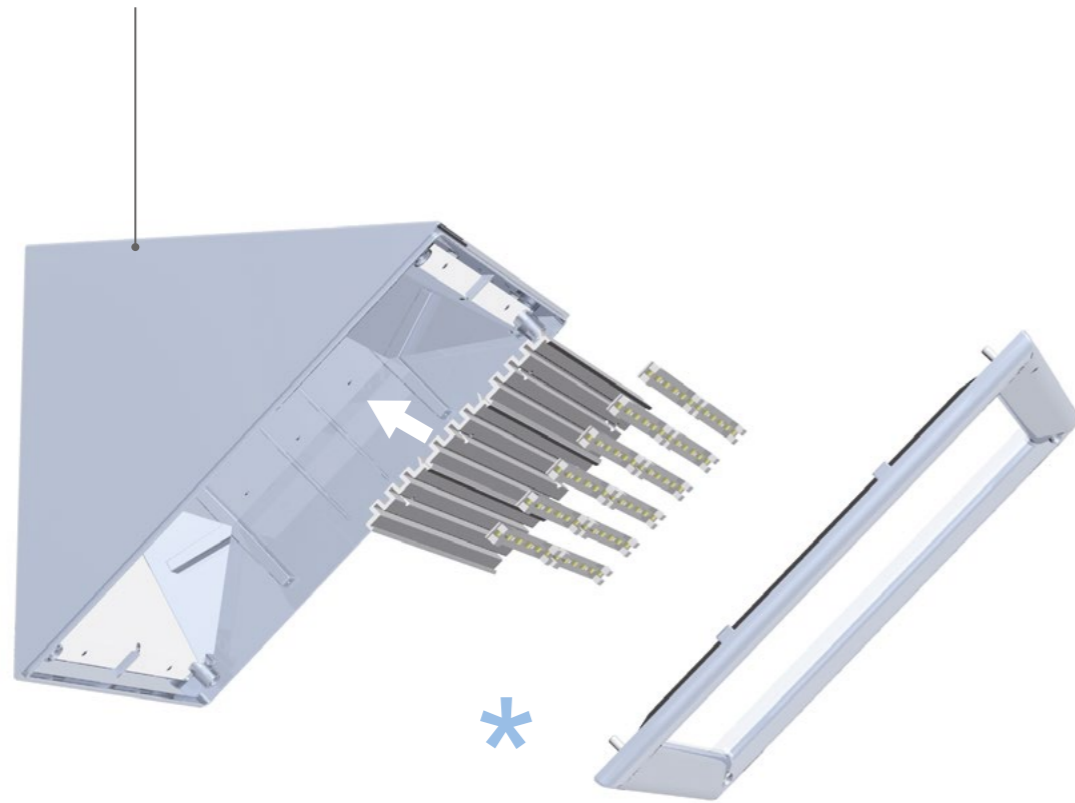

Moduli lineari LED 24V alloggiati su apposito dissipatore per un'omogenea distribuzione della luce sul diffusore.

Linear 24V LED modules mounted on the dedicated heat sink to grant a homogeneous light distribution on the diffuser.

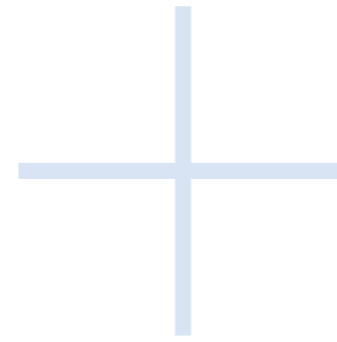

## Struttura versione LED trasparente

Diffusore trasparente in vetro temprato ultrawhite.  
TRIANGOLO grande: corpo e cornice fermavetro in alluminio pressofuso a basso tenore di rame.  
Ingresso cavi dal retro.

## Structure transparent LED version

Transparent diffuser in tempered ultrawhite glass.  
Large TRIANGOLO: body and glazing bead frame in die-cast aluminium with low copper content.  
Rear cable entry.

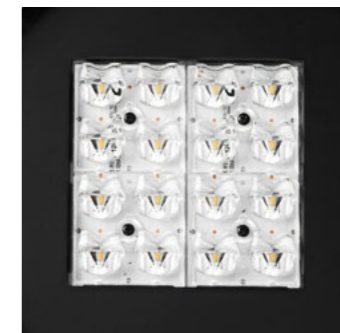

## Ottiche STRADA

Scheda da 16 LED di potenza e 4 lenti STRADA 2x2 alloggiata su apposito dissipatore. 3 aperture del fascio: 25° - 100° - Batwing asimmetrico.

## STRADA optics

16 power LEDs unit and 4 lenses STRADA 2x2 mounted on the dedicated heat sink. 3 beam angles: 25° - 100° - Batwing asymmetric.



# TRIANGOLO

Da parete o palo / Wall or post



## TRIANGOLO PICCOLO OPALE / SMALL OPAL

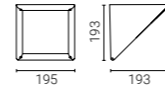

Code			Material	Lamp	W	Lm LED	Real Lm	Optic	Class
4220	● AN - anthracite	27K - 2700K 3K - 3000K 4K - 4000K	polycarbonate	LED	16	2200	1030	diffuse	I
4170	● AG - aluminium grey	-		E 27	75	-	-		II

E 27 L max 120 mm (fornita senza lampadina / supplied without lamp)

# TRIANGOLO

Da parete o palo / Wall or post



## TRIANGOLO GRANDE TRASPARENTE / LARGE TRANSPARENT

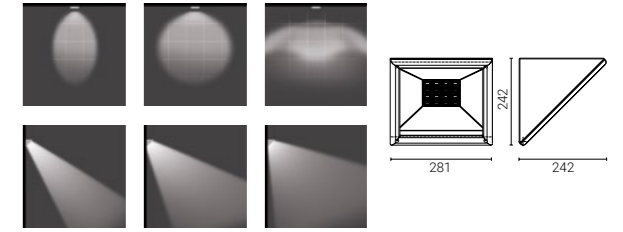

Code			Material	Lamp	W	Lm LED	Real Lm	Optic	Class
4225	● AN - anthracite ● AG - aluminium grey	3K - 3000K 4K - 4000K	aluminium	LED	50	6900	5465	100°	II

Ottiche opzionali / Optional optics 25° (code + **25**), batwing asimmetrico / asymmetric (code + **BAT**)

[Su richiesta / On request](#)

Versione dimmerabile / Dimmable version

## TRIANGOLO GRANDE OPALE / LARGE OPAL

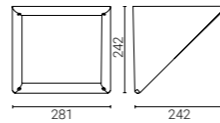

Code			Material	Lamp	W	Lm LED	Real Lm	Optic	Class
4223	● AN - anthracite	3K - 3000K 4K - 4000K	aluminium	LED	34,5	3400	1684	diffuse	II
4229	● AG - aluminium grey	-		LED 3h emergency		3400/350	1684/173		
4230	-	-		E 27	150	-	-		

E 27 L max 190 mm (fornita senza lampadina / supplied without lamp)

[Su richiesta / On request](#)

4223, 4229 Versione dimmerabile / Dimmable version

4223, 4229 24V low voltage (code + **24V**)

## PALI / POSTS H 800-1100

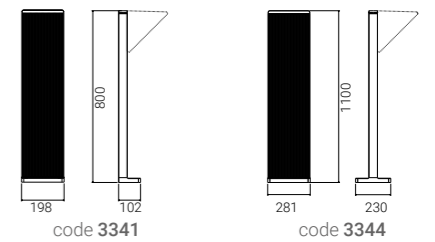
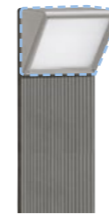

Code	H	Description	Ref. to
3341	800 mm	Palo in alluminio estruso, tappo superiore e basetta in alluminio pressofuso, sottopiede anticorrosione in gomma. Completo di cassetta di derivazione / Post in extruded aluminium, top cover and base in die-cast aluminium, rubber plate against corrosion under the base. Recessed junction box included	code 4220 code 4170
3344	1100 mm		code 4223 code 4229 code 4230 code 4225

Apparecchi TRIANGOLO forniti separatamente / TRIANGOLO fittings supplied separately

[Su richiesta / On request](#)

Possibile montaggio di un secondo TRIANGOLO contrapposto / Possible mounting of a second opposite TRIANGOLO

● AG - aluminium grey



## VOLTO



VOLTO è un apparecchio speciale nel suo genere, capace di esprimere il suo molteplice potenziale a seconda del tipo di installazione, coadiuvato dai diversi accessori.

Con la sua linea semplice e immediatamente riconducibile alle classiche forme triangolari di Goccia Illuminazione è stato concepito ed implementato per l'illuminazione d'effetto in contesto storico, ovvero cornici o capitelli per volti, arcate, loggiati e portici. Le performanti sorgenti e ottiche LED, la resistente costruzione di dimensioni contenute ed il design moderno pulito hanno reso VOLTO un ottimo strumento illuminotecnico in chiave contemporanea, per un'illuminazione scenografica come wall washer e proiettore.

VOLTO is a special device of its kind, capable of expressing its multiple potential according to the type of installation, completed by the various accessories.

With its simple line and immediately attributable to the classic triangular shapes of Goccia Illuminazione, it was conceived and implemented for effect lighting in a historical context, that is ledges or capitals for facades, arches, loggias and porticoes. The high-performance LED sources and optics, the resistant construction of small dimensions and the clean modern design have made VOLTO an excellent lighting tool in a contemporary key, for scenographic lighting such as wall washers and floodlights.

## WALL EFFECTS



VOLTO

# VOLTO

## Luce omogenea

La particolare forma triangolare con i riflettori dedicati permette una distribuzione omogenea della luce su archi e volti.

## Homogeneous light

The particular triangular shape with the dedicated reflectors grants a homogeneous light distribution on arches and vaults.



## Struttura

Diffusore in vetro temprato trasparente, corpo e cornice fermavetro in alluminio pressofuso a basso tenore di rame. Posizionabile con orientamento verso l'alto o verso il basso. Ingresso cavi dal retro.

## Structure

Transparent and tempered glass diffuser, low copper content die-cast aluminium body and glazing bead frame. Adjustable upwards or downwards. Rear cable entry.

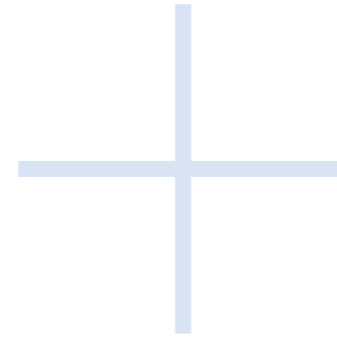

## Luce orientabile

L'apparecchio VOLTO può essere installato per orientare la luce verso l'alto o verso il basso. I bracci snodati consentono la rotazione dell'apparecchio fino a  $\pm 30^\circ$ .

## Adjustable light

VOLTO fittings can be installed to direct light upwards or downwards. The adjustable arms allow for fitting rotation up to  $\pm 30^\circ$ .



## Frangiluce

Il frangiluce dà un effetto anti-abbagliante che crea una luminosità mirata e scenografica sulle volte.

## Louvers

The louvers give an anti-glare effect, creating scenographic light on vaults.



# VOLTO

Effetti a parete / Wall effects



## VOLTO

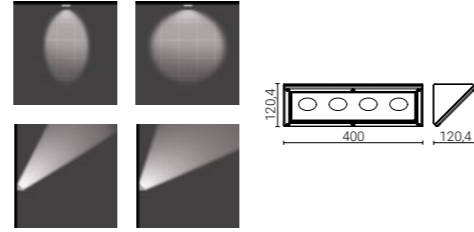

Code	
5863	<ul style="list-style-type: none"> <li><span style="display: inline-block; width: 10px; height: 10px; background-color: black; border-radius: 50%; margin-right: 5px;"></span> NE - black</li> <li><span style="display: inline-block; width: 10px; height: 10px; background-color: grey; border-radius: 50%; margin-right: 5px;"></span> AG - aluminium grey</li> </ul>
	27K - 2700K 3K - 3000K 4K - 4000K

Lamp	W	Lm LED	Real Lm	Optic
LED	4x6,5	3804	2950	38°

Ottica opzionale / Optional optic 90° (code + 90)

Su richiesta / On request  
Versione dimmerabile / Dimmable version



# VOLTO

Accessori / Accessories



## FRANGILUCE / LOUVERS

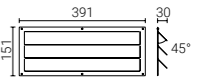

Code	
5864	<ul style="list-style-type: none"> <li><span style="display: inline-block; width: 10px; height: 10px; background-color: black; border-radius: 50%; margin-right: 5px;"></span> NE - black</li> <li><span style="display: inline-block; width: 10px; height: 10px; background-color: grey; border-radius: 50%; margin-right: 5px;"></span> AG - aluminium grey</li> </ul>

Description
Frangiluce con alette orientabili in acciaio zincato e verniciato / Adjustable louvers in galvanized steel and UV resistant coating surface

## BRACCI SNODATI / ADJUSTABLE ARMS

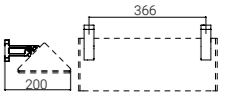

Code	
5081	<ul style="list-style-type: none"> <li><span style="display: inline-block; width: 10px; height: 10px; background-color: black; border-radius: 50%; margin-right: 5px;"></span> NE - black</li> <li><span style="display: inline-block; width: 10px; height: 10px; background-color: grey; border-radius: 50%; margin-right: 5px;"></span> AG - aluminium grey</li> </ul>

Description
Coppia di bracci snodati in alluminio, orientabili verso l'alto o verso il basso / Aluminium wall arms, adjustable upwards or downwards

Rotazione consentita / Rotation allowed  $\pm 30^\circ$

## SUPPORTI BASCULANTI / TILTING BRACKETS

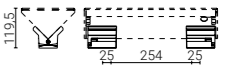

Code	
5066	<ul style="list-style-type: none"> <li><span style="display: inline-block; width: 10px; height: 10px; background-color: black; border-radius: 50%; margin-right: 5px;"></span> NE - black</li> <li><span style="display: inline-block; width: 10px; height: 10px; background-color: grey; border-radius: 50%; margin-right: 5px;"></span> AG - aluminium grey</li> </ul>

Description
Coppia di supporti in alluminio pressofuso / Die-cast aluminium brackets pair

Orientabilità / Adjustable  $\pm 15^\circ$

## CORINTHIA



L'illuminazione architettonica d'effetto incontra uno stile senza tempo, così nasce CORINTHIA. I cilindri, finemente scanalati, accolgono sorgenti luminose di assoluta avanguardia. Grazie alle specifiche soluzioni tecniche, la versione Ø 120 è basculante ed inclinabile in modo da orientare la luce verso la parete per modularne l'effetto.

Particolare cura è stata posta nella realizzazione del cristallo temperato di chiusura, fresato a filo struttura per impedire ristagni e diffondere in modo ottimale la luce. Potenze e dimensioni rendono CORINTHIA ideale per l'illuminazione di facciate in svariati contesti, urbani o residenziali, classici o, per contrasto, moderni e contemporanei.

Architectural effect lighting meets timeless style, thus CORINTHIA was born. The cylinders, finely carved, welcome light sources of absolute avant-garde. Thanks to the specific technical solutions, the Ø 120 version is tilting in order to adjust the beam direction towards the wall and to modulate the effect of the light. Particular attention has been paid to the realization of the tempered closing glass, milled flush with the structure to prevent stagnation and diffuse the light in an optimal way. Powers and dimensions make CORINTHIA ideal for lighting facades in various contexts, urban or residential, classic or, by contrast, modern and contemporary.

## WALL EFFECTS

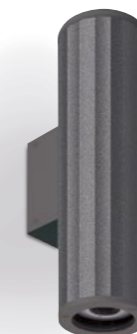
CORINTHIA Ø 60  
1 lightCORINTHIA Ø 60  
2 lightsCORINTHIA Ø 120  
1 lightCORINTHIA Ø 120  
2 lights



# CORINTHIA

## Cristallo anti ristagno

Per impedire ristagni d'acqua sulla faccia superiore, il cristallo temperato di chiusura è fresato a filo struttura.

## Anti-stagnation crystal

The glass, flush with the frame, avoids water stagnation.



Lampada singola o doppia  
1 or 2 lights available

## Struttura

Diffusore in vetro temprato trasparente. Corpo in alluminio estruso scanalato. Cornici fermavetro e scatola di fissaggio a muro in alluminio pressofuso a basso tenore di rame.

## Structure

Transparent tempered glass diffuser. Striated extruded aluminium body. Glazing bead frame and box to fix to wall in die-cast aluminium with low copper content.

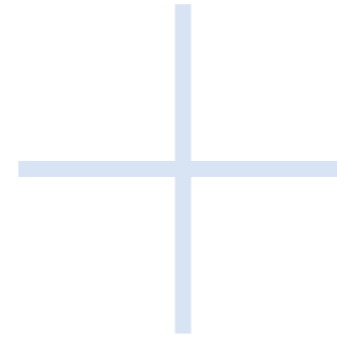

## Basculaggio

Le ottiche del Ø 120 sono basculanti e regolabili con un'angolazione fino a  $\pm 10^\circ$ , in modo da orientare la luce verso la parete per accentuare l'effetto wall-washer.

## Tilting

The  $\varnothing 120$  optics are adjustable  $\pm 10^\circ$ , in order to accent the light effect on the wall, when required.



# CORINTHIA

Effetti a parete / Wall effects



## CORINTHIA Ø 60 mm

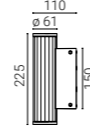

### Code

1204	AN - anthracite	27K - 2700K 3K - 3000K
1203	AG - aluminium grey	4K - 4000K

### Lamp

Lamp	W	Lm LED	Real Lm	Optic
LED	1x3	300	163	1x18°
	2x3	600	326	2x18°

Ottiche opzionali / Optional optics  
38° (code + 38), 90° (code + 90)

# CORINTHIA

Accessori / Accessories



## GIUNTO STAGNO / WATERPROOF CONNECTION

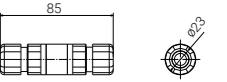

### Code

1943

### Description

Connessione singola presa-spina 3x2,5 mm² IP68 / Plug/socket connector 3x2,5 mm² IP 68

## CORINTHIA Ø 120 mm

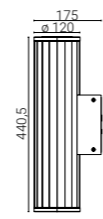
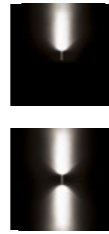

### Code

1213		
1232	AN - anthracite	27K - 2700K 3K - 3000K
1208	AG - aluminium grey	4K - 4000K
1231		

### Lamp

Lamp	W	Lm LED	Real Lm	Optic
LED	1x11	1405	1090	1x18°
	1x18	2761	2000	1x18°
	2x11	2810	2180	2x18°
	2x18	5522	4000	2x18°

Ottiche opzionali / Optional optics  
1213, 1208 38° (code + 38), 1232, 1231 50° (code + 50),  
1213, 1232, 1208, 1231 90° (code + 90)

Sorgente luminosa basculante / Adjustable light source ±10°

### Su richiesta / On request

Versione dimmerabile / Dimmable version

Versione emergenza / Emergency version

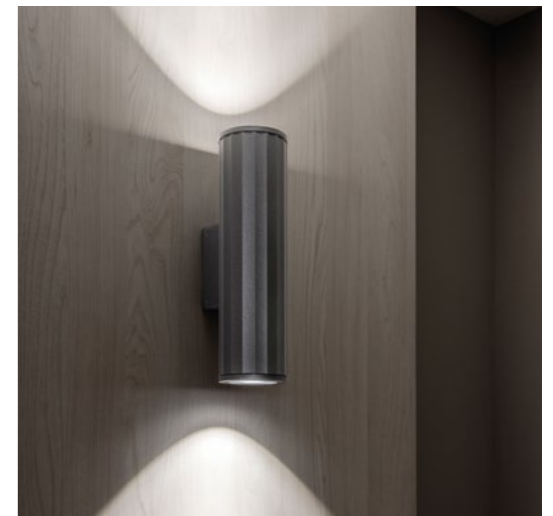



DOWNLIGHT

DOWNLIGHT

# LUX SHOWER



Le soluzioni per l'illuminazione downlight di LUX SHOWER si articolano in tre diverse dimensioni per l'installazione sulla superficie di partizioni orizzontali e coperture, con numerose varianti di apertura dei fasci luminosi. Le tre dimensioni e le diverse portate illuminanti trovano una cifra estetica e di stile adatta al tipo ed all'altezza di installazione, offrendo tutte una solida struttura in alluminio e vetro temprato per garantire una tenuta IP 65.

The LUX SHOWER downlight solutions are divided into three different sizes for installation on the surface of horizontal partitions and roofs, with numerous variations of the light beam angles. Three dimensions and the different illuminating ranges find an aesthetic and style reason suited to the type and height of installation, all offering a solid structure in aluminum and tempered glass to guarantee an IP 65 rating.

## CEILING

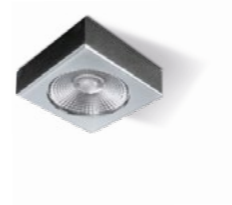

LUX SHOWER  
30



LUX SHOWER  
100

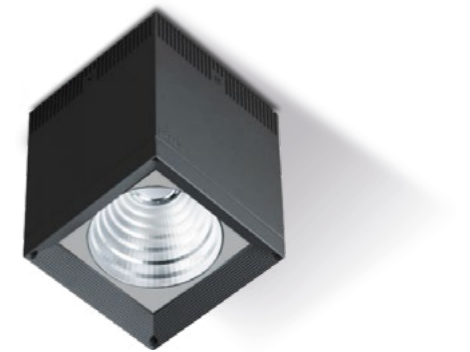

LUX SHOWER  
200

# LUX SHOWER

## Struttura

Diffusore in vetro temperato. Corpo lampada, basetta e cornice fermavetro in alluminio primario anticorrosione a basso tenore di rame. Ingresso cavi dal retro.

## Structure

Tempered glass diffuser. Light body, base and frame in primary low copper content aluminium alloy, UV and harsh conditions resistant. Rear cable entry.

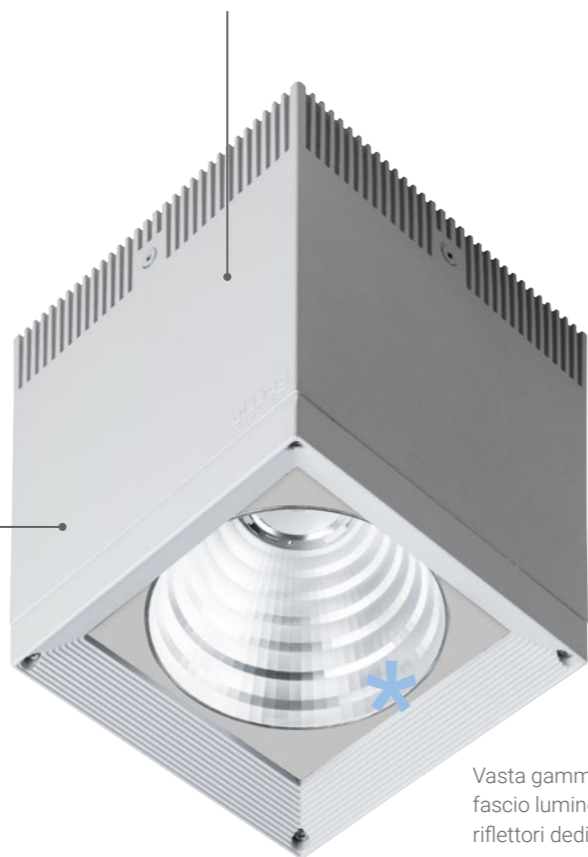

Vasta gamma di aperture del fascio luminoso grazie a lenti e riflettori dedicati.

Wide range of beam angles available thanks to the incorporated optical reflectors

## Dimensioni

Disponibili in 3 dimensioni con 36-102-200 mm di altezza.

## Dimensions

Available in three dimensions with 36-102-200 mm height.



## Minimo spessore

Apparecchio di soli 36 mm di spessore con potente ottica LED integrata funzionante a 230V. Tre angoli di diffusione: 12°- 40°- 90° e versione opale.

## Minimum thickness

Ceiling fixture with only 36 mm thickness and 230V LED module inside. 3 beam angles: 12°- 40°- 90° and opal version.



## Potenza in un minicubo

L'apparecchio di soli 100 mm di lato, grazie al LED 15W con parabola integrata, offre un'elevata resa luminosa. 3 angoli di diffusione: 18°-38°- 90° e vetro opale.

## Minimal design and high efficiency

A 100x100 mm minicube with 15W LED and optical reflectors ensures high performances. 3 beam angles: 18°- 38°- 90° and opal glass.



# LUX SHOWER

Soffitto / Ceiling



## LUX SHOWER 30

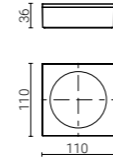

Code	
1221	● AN - anthracite ● AG - aluminium grey ○ BI - white
	27K - 2700K 3K - 3000K 4K - 4000K

Lamp	W	Lm LED	Real Lm	Optic
LED	10	1100	750	40°
			363	diffuse

Ottiche opzionali / Optional optics  
1221 12° (code + **12**), 90° (code + **90**)

1222 Versione opale / Opal version

Modulo LED a tensione di rete, compatibile con dimmer a taglio di fase /  
Mains voltage LED module, compatible with most phase-cut dimmers

Ingresso cavi laterale mediante distanziale cod. 5351 / Side cable entry by the  
accessory code 5351 (page 81)

**Su richiesta / On request**

24V low voltage (code + **24V**)

# LUX SHOWER

Soffitto / Ceiling



## LUX SHOWER 100

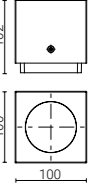

Code	
1225	● AN - anthracite ● AG - aluminium grey ○ BI - white
	27K - 2700K 3K - 3000K 4K - 4000K

Lamp	W	Lm LED	Real Lm	Optic
LED	15	1575	950	38°
			419	diffuse

Ottiche opzionali / Optional optics  
1225 18° (code + **18**), 90° (code + **90**)

1226 Versione opale / Opal version

Modulo LED a tensione di rete, compatibile con dimmer a taglio di fase /  
Mains voltage LED module, compatible with most phase-cut dimmers

**Su richiesta / On request**

12-24V low voltage

## LUX SHOWER 200

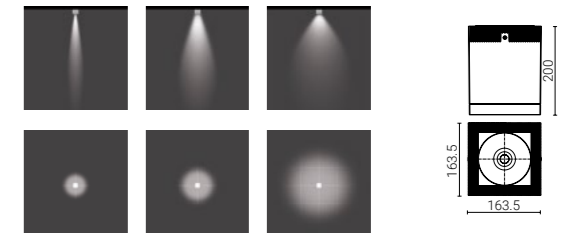
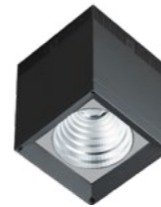

Code	
1087	● AN - anthracite ● AG - aluminium grey ○ BI - white
	27K - 2700K 3K - 3000K 4K - 4000K

Lamp	W	Lm LED	Real Lm	Optic
LED	23	3329	2434	38°

Ottiche opzionali / Optional optics  
18° (code + **18**), 70° (code + **70**)

**Su richiesta / On request**

Versione dimmerabile / Dimmable version



## DOWNLIGHT

## DOWNLIGHT

# KYKLO



Nata come una nuova serie per l'illuminazione downlight a soffitto, KYKLO si presenta nella sua versione rotonda con spessore ridotto per soddisfare le peculiarità della luce di questa applicazione con un disegno essenziale. Una volontà estetica che permette a KYKLO di enfatizzare la purezza del diffusore in vetro a filo, offrendo la versatilità illuminotecnica delle sorgenti LED e delle ottiche studiate per la serie.

Developed as a new series for ceiling mounted downlighting, KYKLO presents itself in its round version with reduced thickness to satisfy the uniqueness of this application's light, with an essential design. An aesthetic desire which enables KYKLO to emphasize the purity of the glass flush diffuser, with all the lighting versatility of LED sources and optics designed for the series.

### CEILING



KYKLO DOWNLIGHT  
Ø 130 flat



KYKLO DOWNLIGHT  
Ø 130 flat opal



# KYKLO DOWNLIGHT

Il diffusore circolare in vetro a filo col corpo lampada definisce un bordo raffinato che conferisce leggerezza ed uno stile inconfondibile.

The round glass diffuser flush with the lamp body defines a refined edge which adds lightness and a distinctive style.



## Struttura

Solida struttura in alluminio pressofuso a basso tenore di rame e viti inox. Sorgenti LED dedicate e vetri temprati ultrawhite. Ingresso cavi dal retro.

## Structure

Low copper content die-cast aluminium solid structure and stainless steel screws. Dedicated LED sources and ultrawhite tempered glass. Rear cable entry.

## Minimo spessore

L'altezza minima della lampada permette un'installazione a 230V di superficie ed è ottimizzata per consentire l'impiego di diverse ottiche per diffondere la luce.

## Minimum thickness

The minimum height of the lamp is designed for 230V surface installation and is optimised to enable the use of different light diffusion optics.

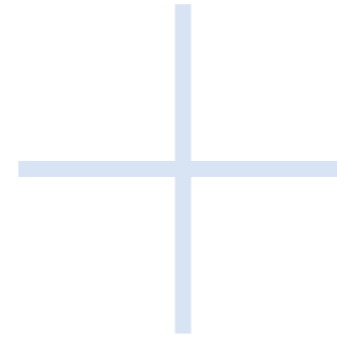

## Ottiche

Ottiche e lenti speciali per diverse aperture del fascio luminoso.

## Optics

Special optics and lenses for different light beam angles.









## KYKLO DOWNLIGHT

Soffitto / Ceiling

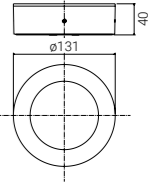

### KYKLO DOWNLIGHT Ø 130 mm FLAT



		Code	
1241	 AN - anthracite	27K - 2700K	
	 AG - aluminium grey	3K - 3000K	
	 BI - white	4K - 4000K	

Lamp	W	Lm LED	Real Lm	Optic
LED	10	1100	750	40°

Ottiche opzionali / Optional optics  
12° (code + 12), 90° (code + 90)

Modulo LED a tensione di rete, compatibile con dimmer a taglio di fase /  
Mains voltage LED module, compatible with most phase-cut dimmers



**Su richiesta / On request**

24V low voltage (code + 24V)

Ottica a nido d'ape / Honeycomb optic 10° (code + HC)

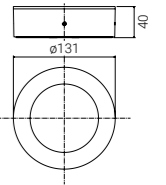
### KYKLO DOWNLIGHT Ø 130 mm FLAT OPAL



		Code	
1242	 AN - anthracite	27K - 2700K	
	 AG - aluminium grey	3K - 3000K	
	 BI - white	4K - 4000K	

Lamp	W	Lm LED	Real Lm	Optic
LED	10	1100	363	diffuse

Versione opale / Opal version

Modulo LED a tensione di rete, compatibile con dimmer a taglio di fase /  
Mains voltage LED module, compatible with most phase-cut dimmers

**Su richiesta / On request**

24V low voltage (code + 24V)



PLAFONIERE DA  
PARETE O SOFFITTO

WALL OR CEILING  
FITTINGS

# LUNETTE



Per l'installazione a soffitto e a parete LUNETTE porta un'eleganza discreta e armonia delle proporzioni, definite dal ridotto spessore e dai diametri degli anelli concentrici. Un disegno puro e lineare per enfatizzare l'effetto luminoso omogeneo e permettere un'ottima illuminazione nelle diverse versioni. L'altro lato di LUNETTE, celato negli ingombri minimi, offre tutti gli accorgimenti tecnici e di installazione facilitata frutto dell'esperienza di Goccia Illuminazione.

For ceiling and wall installation, LUNETTE brings a discreet elegance and harmony of proportions, defined by the reduced thickness and diameters of the concentric rings. A pure and linear design to emphasize the homogeneous light effect and to provide excellent lighting in the different versions. The other side of LUNETTE, concealed in its minimal dimensions, offers all the technical and easy installation features resulting from Goccia Illuminazione's experience.

WALL OR CEILING



LUNETTE  
Ø 235

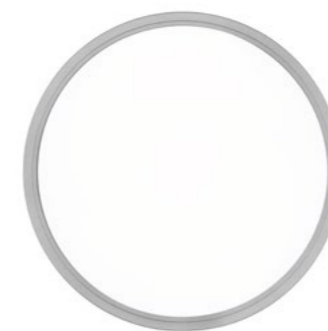

LUNETTE  
Ø 365

# LUNETTE

## Struttura

Corpo lampada in lega di alluminio primario a basso contenuto di rame. Guarnizioni di tenuta in silicone. Diffusore in policarbonato opale anti UV, IK 10 antivandalo.

## Structure

Body in low copper content primary aluminium alloy. Silicone sealing gasket. Opal polycarbonate diffuser UV resistant, IK 10 vandalproof.

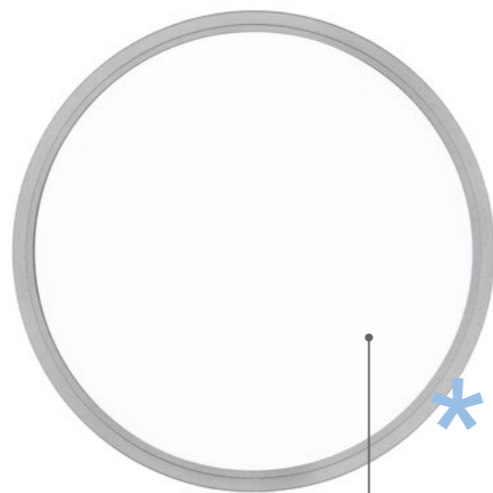

Nessuna vite frontale a vista.  
No visible frontal screws.

## Luce uniforme

Per una migliore distribuzione della luce sono stati inseriti numerosi LED di dimensioni ridotte.

## Uniform lighting

Several small LEDs enable a soft and well lighting distribution.



## Alimentazione passante

Il doppio ingresso cavi permette l'alimentazione passante. L'accessorio distanziale consente l'ingresso cavi laterale.

## Through wiring available

The double cable entry permits an easy through wiring installation. Spacer optional accessory allows a side cable entry.



## Installazione facilitata

La cornice si fissa sulla base con rotazione a scatto. Un grano laterale, avvitabile con la chiave in dotazione, garantisce il bloccaggio permanente.

## Easy installation

The frame can easily be fixed to the base by a snapping rotation. After that - hands free - a side grub can be screwed by the key supplied for a permanent installation.



# LUNETTE

Parete o soffitto / Wall or ceiling



## LUNETTE Ø 235 mm

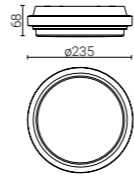

Code		
9201	● AN - anthracite	3K - 3000K 4K - 4000K
	● AG - aluminium grey	
9202	○ BI - white	

Lamp	W	Lm LED	Real Lm	Optic
LED	15	1500	890	diffuse
LED + 3h emergency		1500/360	890/130	

**Su richiesta / On request**

Versione dimmerabile / Dimmable version  
Versione con sensore / Version with sensor

## LUNETTE Ø 365 mm

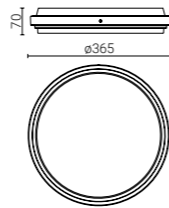

Code		
9206	● AN - anthracite	3K - 3000K 4K - 4000K
	● AG - aluminium grey	
9207	○ BI - white	

Lamp	W	Lm LED	Real Lm	Optic
LED	29	4400	3250	diffuse
LED + 3h emergency		4400/360	3250/130	

**Su richiesta / On request**

Versione dimmerabile / Dimmable version  
Versione con sensore / Version with sensor

# LUNETTE

Accessori / Accessories



## DISTANZIALI / SPACERS



code 9211



code 9212

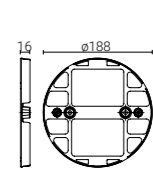

code 9211

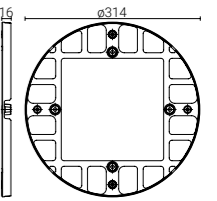

code 9212

Code	Description	Ref. to
9211	Distanziale per ingresso cavi laterale, cablaggio entra/esci consentito / Spacer for side cable entry, through wiring allowed	code 9201 code 9202
9212		code 9206 code 9207



PLAFONIERE DA  
PARETE O SOFFITTO

WALL OR CEILING  
FITTINGS

# DOCKS



DOCKS reinterpreta gli apparecchi di uso e gusto navale, utilizzandone i materiali tipici come l'acciaio inossidabile AISI 316L e l'alluminio marino. Proposte nelle classiche forme con e senza griglia o con palpebra, sono ideali per l'installazione in esterni particolarmente esposti agli agenti atmosferici ed alla corrosione.

Il design classico di DOCKS, la nobiltà e la robustezza dei materiali ne fanno la lampada ideale per strutture in condizioni climatiche difficili e per ogni applicazione si presti ad un connubio di resistenza ed estetica raffinata.

DOCKS reinterprets the appliances of naval use and taste, using typical materials such as AISI 316L stainless steel and marine aluminum. Proposed in the classic shapes with and without guard or with eyelid, they are ideal for outdoor installation particularly exposed to weathering and corrosion.

The classic design of DOCKS, the nobility and the robustness of the materials make it the ideal lamp for structures in difficult climatic conditions and for each application needing a combination of resistance and refined aesthetics.

WALL OR CEILING



DOCKS  
with ring



DOCKS  
with guard



DOCKS  
with eyelid



## DOCKS

### Struttura

Diffusore in policarbonato opale IK 10 antivandalo. Guarnizioni di tenuta in silicone. Corpo in alluminio pressofuso a basso tenore di rame o inox AISI 316L. Base in alluminio pressofuso. Piattello interno reggicablaggio in Al 99,8 con ingresso cavi dal retro. Viti inox.

### Structure

IK 10 vandalproof opal polycarbonate diffuser. Silicone sealing gaskets. Body in low copper content die-cast aluminium or AISI 316L stainless steel. Die-cast aluminium base. Internal wire holder plate in Al 99,8 with cable entry from the back. Stainless steel screws.

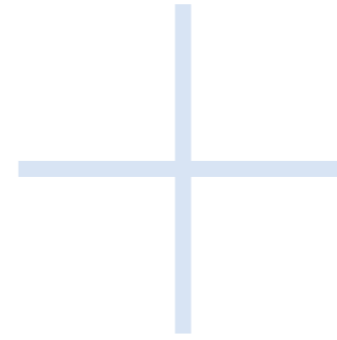

### Materiali

Alluminio marino con viti inox, resistente finitura a doppia verniciatura: decapaggio, passivazione cromica trivalente, fondo epossidico e verniciatura con polveri poliestere. Acciaio inox AISI 316L con viti inox, maschera tornita da lastra, finitura spazzolata e satinata.

### Materials

Marine aluminium + stainless steel screws, resistant finishing with double paint coating: pickling, trivalent chromic passivation, epoxy bottom and polyester powder coating. AISI 316L stainless steel, brushed and thin satined. Stainless steel screws.



# DOCKS

Parete o soffitto / Wall or ceiling



## DOCKS CON ANELLO / WITH RING



aluminium AISI 316L stainless steel

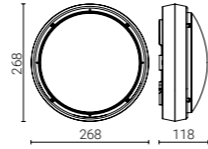

Code			Material	Lamp	W	Lm LED	Real Lm	Optic
9104	● AN - anthracite	27K - 2700K 3K - 3000K 4K - 4000K	aluminium	LED	15	1575	600	diffuse
	● AG - aluminium grey	-		E27	75	-	-	
9060	○ BI - white	-	AISI 316L stainless steel	LED	15	1575	600	
9108	● IN - stainless steel	27K - 2700K 3K - 3000K 4K - 4000K		E27	75	-	-	
9070	-	-		-	-	-	-	

Modulo LED a tensione di rete, compatibile con dimmer a taglio di fase /  
Mains voltage LED module, compatible with most phase-cut dimmers  
E27 L max 160 mm (fornite senza lampadina / supplied without lamp)

[Su richiesta / On request](#)  
Versione dimmerabile / Dimmable version

# DOCKS

Parete o soffitto / Wall or ceiling



## DOCKS CON PALPEBRA / WITH EYELID



aluminium AISI 316L stainless steel

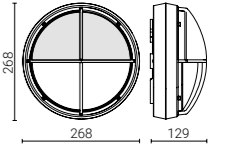

Code			Material	Lamp	W	Lm LED	Real Lm	Optic
9127	● AN - anthracite	27K - 2700K 3K - 3000K 4K - 4000K	aluminium	LED	15	1575	298	diffuse
	● AG - aluminium grey	-		E27	75	-	-	
9067	○ BI - white	-	AISI 316L stainless steel	LED	15	1575	298	
9138	● IN - stainless steel	27K - 2700K 3K - 3000K 4K - 4000K		E27	75	-	-	
9077	-	-		-	-	-	-	

Modulo LED a tensione di rete, compatibile con dimmer a taglio di fase /  
Mains voltage LED module, compatible with most phase-cut dimmers  
E27 L max 160 mm (fornite senza lampadina / supplied without lamp)

[Su richiesta / On request](#)  
Versione dimmerabile / Dimmable version

## DOCKS CON GRIGLIA / WITH GUARD



aluminium AISI 316L stainless steel

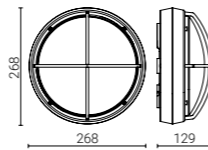

Code			Material	Lamp	W	Lm LED	Real Lm	Optic
9121	● AN - anthracite	27K - 2700K 3K - 3000K 4K - 4000K	aluminium	LED	15	1575	600	diffuse
	● AG - aluminium grey	-		E27	75	-	-	
9064	○ BI - white	-	AISI 316L stainless steel	LED	15	1575	600	
9133	● IN - stainless steel	27K - 2700K 3K - 3000K 4K - 4000K		E27	75	-	-	
9074	-	-		-	-	-	-	

Modulo LED a tensione di rete, compatibile con dimmer a taglio di fase /  
Mains voltage LED module, compatible with most phase-cut dimmers  
E27 L max 160 mm (fornite senza lampadina / supplied without lamp)

[Su richiesta / On request](#)  
Versione dimmerabile / Dimmable version



PLAFONIERE DA  
PARETE O SOFFITTO

WALL OR CEILING  
FITTINGS

# KASKO



Le forme pulite, i materiali tecnici e le finiture pregiate rendono KASKO ideale per ogni contesto architettonico di illuminazione esterna caratterizzato da stile e resistenza nel tempo. Una lampada robusta, IP65, concepita fin dall'origine nella sua versione antivandalo per gli spazi pubblici, KASKO nasce per garantire la tenuta stagna e le qualità illuminotecniche anche nelle condizioni di installazione più difficili.

The clean shapes, the technical materials and the fine finishes make KASKO ideal for any architectural context of outdoor lighting characterized by style and resistance over time. A sturdy lamp, IP65, conceived from the outset in its vandal-proof version for public spaces, KASKO was created to guarantee watertightness and lighting qualities even in the most difficult installation conditions.

## WALL OR CEILING



KASKO Ø 198  
with ring

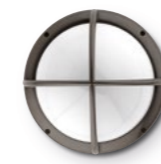

KASKO Ø 198  
with guard



KASKO Ø 198  
with eyelid



KASKO Ø 260  
with ring



KASKO Ø 260  
with guard



KASKO Ø 260  
with eyelid



KASKO oval  
with guard



KASKO oval  
with eyelid

# KASKO

## Struttura

Diffusore in vetro opale stampato o policarbonato opale IK10 antivandalo. Guarnizioni di tenuta in silicone. Corpo in alluminio pressofuso a basso tenore di rame. Base in alluminio pressofuso. Piattello interno reggicablaggio in Al 99,8. Viti a brugola in acciaio inox.

## Structure

Moulded opal glass or IK 10 vandalproof opal polycarbonate diffuser. Silicone sealing gaskets. Low copper content die-cast aluminium body. Die-cast aluminium base. Internal wire holder plate in Al 99,8. Stainless steel Allen key screws.



Alimentazione passante possibile  
Through wiring allowed

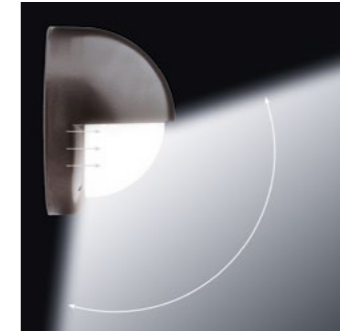
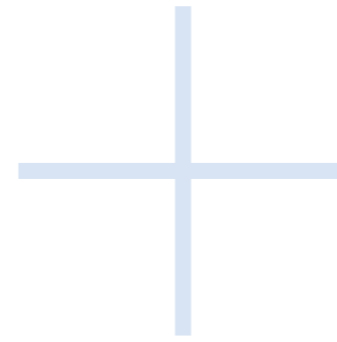

## Irraggiamento verso il basso

La forma emisferica è stata progettata per allontanare dalla base la lampada portandola nella posizione migliore per diffondere più efficacemente la luce. Il portalamпада è posizionato in alto, grazie al precablaggio con cavi resistenti al calore. La luce viene così irradiata verso il basso.

## Downward light distribution

KASKO has been designed with its hemispherical shape to provide maximum illumination. The lampholder is installed on the top and the light is oriented downwards.







## KASKO CON ANELLO / WITH RING Ø 198 mm

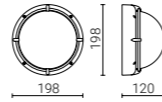

Code	
8410	● AN - anthracite
	● AG - aluminium grey
8490*	○ BI - white

Lamp	W	Lm LED	Real Lm	Optic
E27	100	-	-	diffuse
	75			

\*Diffusore in policarbonato antivandalo IK10 / IK10 vandalproof polycarbonate diffuser  
E27 L max 117 mm (fornite senza lampadina / supplied without lamp)

CRI≥80

## KASKO CON ANELLO / WITH RING Ø 260 mm

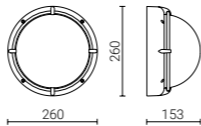

Code		
9150	● AN - anthracite	27K - 2700K
9154*		3K - 3000K
		4K - 4000K
8420	● AG - aluminium grey	-
8495*	○ BI - white	

Lamp	W	Lm LED	Real Lm	Optic
LED	15	1575	645	diffuse
E27	150	-	-	
	100			

\*Diffusore in policarbonato antivandalo IK10 / IK10 vandalproof polycarbonate diffuser  
Modulo LED a tensione di rete, compatibile con dimmer a taglio di fase / Mains voltage LED module, compatible with most phase-cut dimmers  
E27 L max 145 mm (fornite senza lampadina / supplied without lamp)

**Su richiesta / On request**  
Versione dimmerabile / Dimmable version



## KASKO CON GRIGLIA / WITH GUARD Ø 198 mm

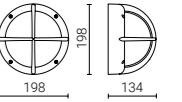

Code	
8310	● AN - anthracite
	● AG - aluminium grey
8390*	○ BI - white

Lamp	W	Lm LED	Real Lm	Optic
E27	100	-	-	diffuse
	75			

\*Diffusore in policarbonato antivandalo IK10 / IK10 vandalproof polycarbonate diffuser  
E27 L max 117 mm (fornite senza lampadina / supplied without lamp)

CRI≥80

## KASKO CON GRIGLIA / WITH GUARD Ø 260 mm

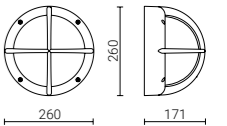

Code		
9160	● AN - anthracite	27K - 2700K
9164*		3K - 3000K
		4K - 4000K
8320	● AG - aluminium grey	-
8395*	○ BI - white	

Lamp	W	Lm LED	Real Lm	Optic
LED	15	1575	645	diffuse
E27	150	-	-	
	100			

\*Diffusore in policarbonato antivandalo IK10 / IK10 vandalproof polycarbonate diffuser  
Modulo LED a tensione di rete, compatibile con dimmer a taglio di fase / Mains voltage LED module, compatible with most phase-cut dimmers  
E27 L max 145 mm (fornite senza lampadina / supplied without lamp)

**Su richiesta / On request**  
Versione dimmerabile / Dimmable version



## KASKO CON PALPEBRA / WITH EYELID Ø 198 mm

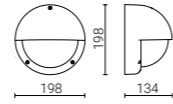

Code	
8610	● AN - anthracite
	● AG - aluminium grey
8690*	○ BI - white

\*Diffusore in policarbonato antivandalo IK10 / IK10 vandalproof polycarbonate diffuser  
E27 L max 117 mm (fornite senza lampadina / supplied without lamp)

Lamp	W	Lm LED	Real Lm	Optic
E27	75	-	-	diffuse
	60	-	-	

## KASKO CON PALPEBRA / WITH EYELID Ø 260 mm

CRi>80

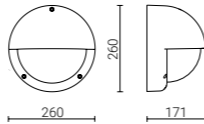

Code	
9170	● AN - anthracite
9174*	● AG - aluminium grey
8620	○ BI - white
8695*	

\*Diffusore in policarbonato antivandalo IK10 / IK10 vandalproof polycarbonate diffuser  
Modulo LED a tensione di rete, compatibile con dimmer a taglio di fase / Mains voltage LED module, compatible with most phase-cut dimmers  
E27 L max 145 mm (fornite senza lampadina / supplied without lamp)

Lamp	W	Lm LED	Real Lm	Optic
LED	15	1575	303	diffuse
E27	100	-	-	
	75	-	-	

[Su richiesta / On request](#)  
Versione dimmerabile / Dimmable version



## KASKO OVALE CON GRIGLIA / OVAL WITH GUARD

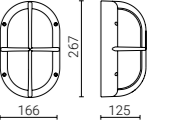

Code	
9182	● AN - anthracite
9184*	● AG - aluminium grey
8110	○ BI - white
8190*	

\*Diffusore in policarbonato antivandalo IK10 / IK10 vandalproof polycarbonate diffuser

Modulo LED a tensione di rete, compatibile con dimmer a taglio di fase / Mains voltage LED module, compatible with most phase-cut dimmers  
E27 L max 173 mm (fornite senza lampadina / supplied without lamp)

Lamp	W	Lm LED	Real Lm	Optic
LED	10	1100	470	diffuse
E27	100	-	-	
	60	-	-	

## KASKO OVALE CON PALPEBRA / OVAL WITH EYELID

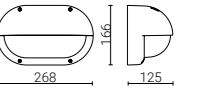

Code	
9186	● AN - anthracite
9187*	● AG - aluminium grey
8810	○ BI - white
8890*	

\*Diffusore in policarbonato antivandalo IK10 / IK10 vandalproof polycarbonate diffuser

Modulo LED a tensione di rete, compatibile con dimmer a taglio di fase / Mains voltage LED module, compatible with most phase-cut dimmers  
E27 L max 173 mm (fornite senza lampadina / supplied without lamp)

Lamp	W	Lm LED	Real Lm	Optic
LED	10	1100	234	diffuse
E27	100	-	-	
	60	-	-	



PLAFONIERE DA  
PARETE O SOFFITTO

WALL OR CEILING  
FITTINGS

# JACK



Il corpo lampada JACK, tondo o ovale, è costituito da un apparecchio a tenuta stagna che contiene la base, la sorgente luminosa, il cablaggio, il diffusore e la cornice di chiusura. Il look finale si crea con le maschere, inserite semplicemente con un sistema a scatto, disponibili in forme e colori diversi. JACK offre una gamma di soluzioni versatile per l'illuminazione di spazi comuni e privati: luce scale, scantinati, corridoi, balconi ed esterni.

The JACK lamp body, round or oval, consists of a watertight luminaire that contains the base, the light source, the wiring, the diffuser and the closing frame - the final look is created with the masks, simply applied with a snap-on system, available in different shapes and colors. JACK offers a range of versatile solutions for the lighting of common and private spaces: staircase, basements, corridors, balconies and exteriors.

WALL OR CEILING

---

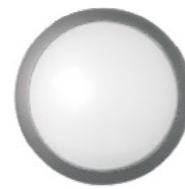

JACK  
round



JACK  
oval

# JACK

## Struttura

La serie JACK è composta da:

- **corpi lampada** in policarbonato con trattamento anti UV, in forma tonda con diffusore opale in policarbonato e in forma ovale con diffusore opale in vetro stampato
- **maschere intercambiabili** in policarbonato con inserimento a scatto

## Structure

The JACK range is composed of:

- **light bodies**, in UV resistant polycarbonate, in round shape with opal polycarbonate diffuser and in oval shape with opal moulded glass diffuser
- **snap covering masks** in polycarbonate

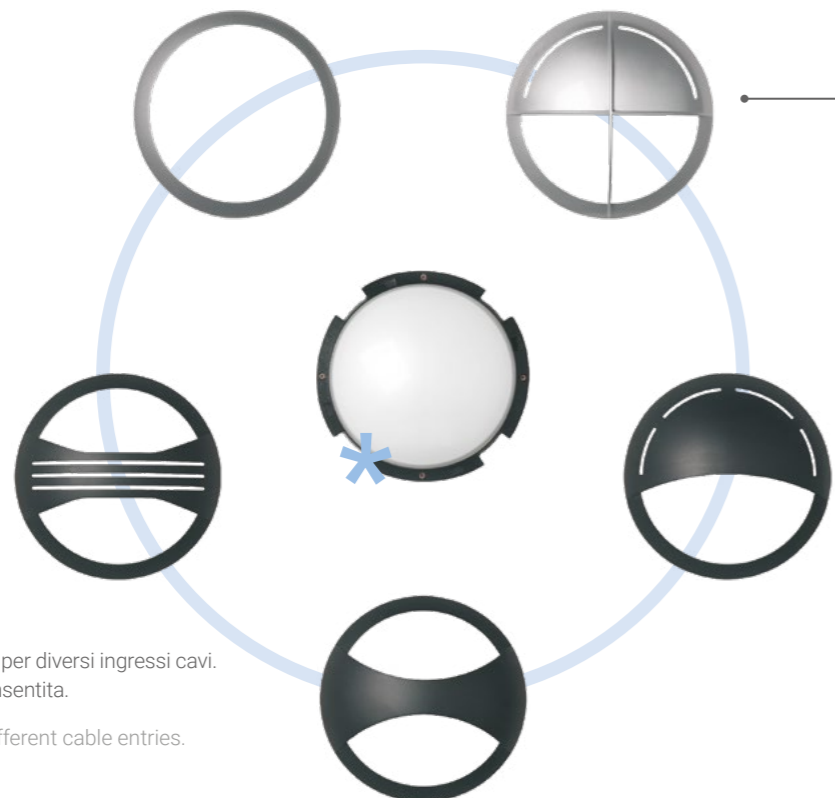

L'apparecchio è predisposto per diversi ingressi cavi. Alimentazione passante consentita.

The fixture is suitable for different cable entries. Through wiring allowed.

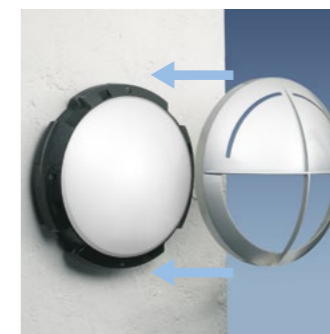
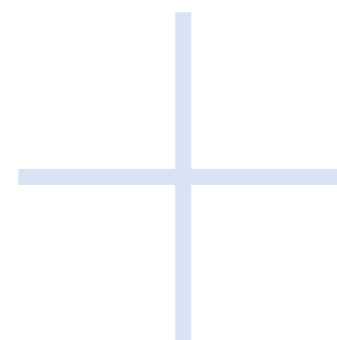

## Massima componibilità

Il look finale si ottiene rivestendo il corpo lampada con apposite "maschere", disponibili in forme e colori diversi, installabili con un semplice scatto, atte a nascondere e proteggere le viti. La lampada assume così, volta per volta, una sua propria personalità.

## Maximum modularity

The final look can be achieved changing the snap covering masks, in different shapes and colours, suitable to hide and protect the screws. The luminaire will achieve different personalities.





# JACK

Parete o soffitto / Wall or ceiling



## CORPI LAMPADA / LIGHT BODIES

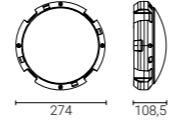

Code	
2191	● NE - black 27K - 2700K 3K - 3000K 4K - 4000K
2291	-

Lamp	W	Lm LED	Real Lm	Optic
LED	10	1100	552	diffuse
E27	75	-	-	

Modulo LED a tensione di rete, compatibile con dimmer a taglio di fase / Mains voltage LED module, compatible with most phase-cut dimmers  
E27 L max 145 mm (fornito senza lampadina / supplied without lamp)

**Su richiesta / On request**  
Versione dimmerabile / Dimmable version  
Versione con sensore / Version with sensor

# JACK

Parete o soffitto / Wall or ceiling



## CORPI LAMPADA / LIGHT BODIES

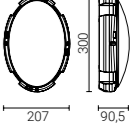

Code	
2143	● NE - black 27K - 2700K 3K - 3000K 4K - 4000K
2241	-

Lamp	W	Lm LED	Real Lm	Optic
LED	10	1100	592	diffuse
E27	60	-	-	

Modulo LED a tensione di rete, compatibile con dimmer a taglio di fase / Mains voltage LED module, compatible with most phase-cut dimmers  
E27 L max 173 mm (fornito senza lampadina / supplied without lamp)

**Su richiesta / On request**  
Versione con sensore / Version with sensor

## MASCHERE / MASKS



code 2213

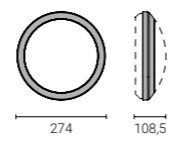

code 2213



code 2214



code 2215



code 2216



code 2217

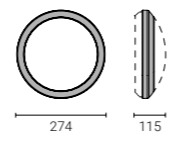

codes  
2214 2215 2216 2217

Code	Description
2213	
2214	● NE - black
2215	● SI - silver
2216	
2217	

Maschera di rivestimento in policarbonato, bloccaggio a scatto senza viti / Covering mask in polycarbonate, screwless snap fixing

**Su richiesta / On request**  
2213 ○ BI - white

## MASCHERE / MASKS



code 2263



code 2264

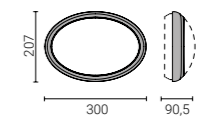

code 2263

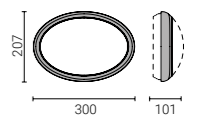

code 2264



code 2265



code 2267

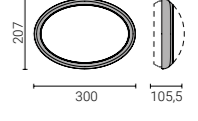

codes 2265 2267

Code	Description
2263	
2264	● NE - black
2265	● SI - silver
2267	

Maschera di rivestimento in policarbonato, bloccaggio a scatto senza viti / Covering mask in polycarbonate, screwless snap fixing

**Su richiesta / On request**  
2263 ○ BI - white

PLAFONIERE DA  
PARETE O SOFFITTO

WALL OR CEILING  
FITTINGS

# MARINA



MARINA è un classico di Goccia Illuminazione. Mantenendo lo stile storico e versatile della linea, si caratterizza con una protezione IP65, con una finitura resistente ai raggi UV, con un cablaggio interno anche per cavi ad alta resistenza termica e con i diffusori in vetro o in policarbonato antivandalo.

MARINA is a classic of Goccia Illuminazione. Maintaining the traditional and versatile style of the line, it is characterized with an IP65 protection, with a UV resistant finish, with an internal wiring also for high thermal resistance cables and with diffusers in glass or vandal-proof polycarbonate.

## WALL OR CEILING



MARINA  
oval



MARINA  
oval with guard



PALPEBRA



MARINA  
round



MARINA  
round with guard



**Struttura**

Diffusore opale in vetro o policarbonato antivandalo. Corpo, anello, griglia e palpebra in policarbonato verniciato con trattamento anti UV. Riflettore in alluminio 99,8 brillantato e precablato.

**Structure**

Opal diffuser in glass or vandalproof polycarbonate. Body, ring, guard and eyelid in painted polycarbonate with UV resistant treatment. 99,8 polished and pre-wired aluminium reflector.



**Ingresso cavi possibile da ogni parte**

- dall'alto con doppia sicurezza
- laterale
- dal basso
- entra ed esci
- dal retro per punto-luce a parete o a soffitto

**Cable entry from any side**

- from the top with double security
- from the side
- from the bottom
- through wiring
- from the rear for wall or ceiling installation

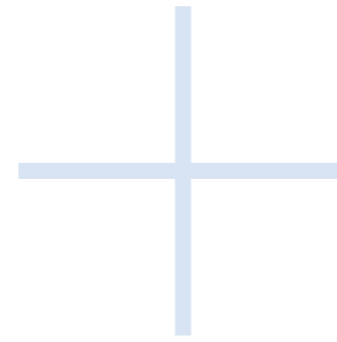

**IP 65 e cablaggio facilitato**

Ingresso cavi dal retro o laterale mediante il pressacavo fornito o giunto chiudi guaina o giunto tubo-scatola.

**IP 65 and easy connection**

Cable entry from either the rear or the side through the supplied cable gland or flexible conduit or rigid conduit adaptor.



# MARINA

Parete o soffitto / Wall or ceiling



## MARINA OVALE / OVAL



L 200 mm

L 270 mm

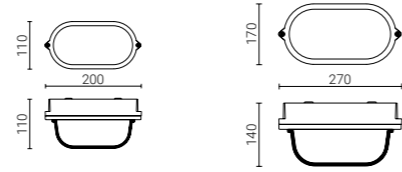

Code	L	Lamp	W	Lm LED	Real Lm	Optic
4560	200 mm	E27	60	-	-	diffuse
4592*	270 mm		75	-	-	

\*Diffusore in policarbonato antivandalo IK10 / IK10 vandalproof polycarbonate diffuser

4560 E27 L max 117 mm (fornita senza lampadina / supplied without lamp)

4592 E27 L max 173 mm (fornita senza lampadina / supplied without lamp)

## MARINA OVALE CON GRIGLIA / OVAL WITH GUARD



L 200 mm

L 270 mm

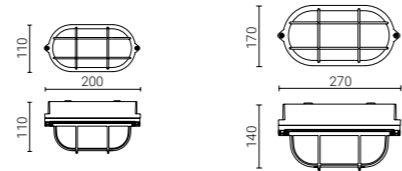

Code	L	Lamp	W	Lm LED	Real Lm	Optic
4510	200 mm	E27	60	-	-	diffuse
4590*	270 mm		75	-	-	

\*Diffusore in policarbonato antivandalo IK10 / IK10 vandalproof polycarbonate diffuser

4510 E27 L max 117 mm (fornita senza lampadina / supplied without lamp)

4590 E27 L max 173 mm (fornita senza lampadina / supplied without lamp)

# MARINA

Parete o soffitto / Wall or ceiling



## PALPEBRA



L 200 mm

L 270 mm

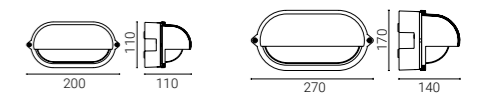

Code	L	Lamp	W	Lm LED	Real Lm	Optic
2806	200 mm	E27	60	-	-	diffuse
2895*	270 mm		75	-	-	

\*Diffusore in policarbonato antivandalo IK10 / IK10 vandalproof polycarbonate diffuser

2806 E27 L max 117 mm (fornita senza lampadina / supplied without lamp)

2895 E27 L max 173 mm (fornita senza lampadina / supplied without lamp)

## MARINA TONDA / ROUND



codes 4780 4792

codes 4720 4790

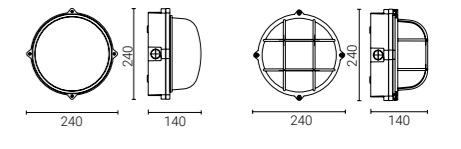

codes 4780 4792

codes 4720 4790

Code	Ø	Lamp	W	Lm LED	Real Lm	Optic
4780	240 mm	E27	100	-	-	diffuse
4792*			75			
4720			100			
4790*			75			

\*Diffusore in policarbonato antivandalo IK10 / IK10 vandalproof polycarbonate diffuser

E27 L max 145 mm (fornite senza lampadina / supplied without lamp)



# RGBW



Il sistema RGBW di Goccia Illuminazione, comandato da centralina remota tramite un segnale trasmesso con protocollo DMX 512 Standard, permette di programmare i LED RGB e miscelare i colori e la luce bianca, secondo il metodo rosso, verde, blu + bianco. La gamma RGBW è composta dalle serie CLOCK, PROTO, K<sup>3</sup> e PASSUM UP, dotate del dispositivo per la ricezione del segnale, e dal generatore remoto per la gestione delle varie funzioni.

RGBW di Goccia Illuminazione è un applicativo da esterno di qualità per tutte le installazioni in cui l'effetto cromatico luminoso vada ad esaltare l'architettura e le strutture.

The RGBW system by Goccia Illuminazione, controlled by a remote control unit through a signal transmitted with the DMX 512 Standard protocol, allows to program the RGB LEDs and mix the colors and white light, according to the red, green, blue + white method. The RGBW range consists of the CLOCK, PROTO, K<sup>3</sup> and PASSUM UP series, equipped with the device to receive the signal, and of the remote generator to manage the various functions.

RGBW by Goccia Illuminazione is a quality outdoor application for all installations in which the luminous chromatic effect enhances the architecture and structures.

## GROUND OR WALL RECESSED



RGBW PASSUM UP  
Ø 125



RGBW PASSUM UP  
Ø 180



RGBW PASSUM UP  
Ø 245

## SPOTLIGHT



RGBW CLOCK  
Ø 80



RGBW CLOCK  
Ø 120



RGBW PROTO

## WALL EFFECTS



RGBW K<sup>3</sup>  
1 window



RGBW K<sup>3</sup>  
2 windows

# RGBW

## Sistema RGBW

Il sistema RGBW di Goccia Illuminazione, comandato da centralina remota attraverso un segnale trasmesso con protocollo DMX 512 Standard, è composto dagli apparecchi CLOCK, PROTO, K<sup>3</sup> e PASSUM UP dotati di dispositivo per ricevere il segnale. Il generatore di segnale DMX è fornito comprensivo di scatola da incasso e consente la regolazione di tutti gli apparecchi.

## RGBW System

The RGBW system by Goccia Illuminazione, controlled by the remote unit through a signal transmitted via Standard DMX 512 protocol, is composed of CLOCK, PROTO, K<sup>3</sup> and PASSUM UP fittings equipped with a device for signal receipt. DMX signal generator is supplied with its backbox and allows the user to regulate all fittings.

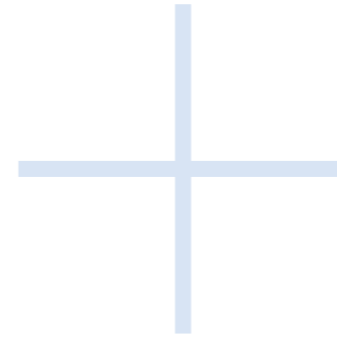

## Ampia gamma fasci e colori

Grazie alle lenti ad elevate prestazioni sono disponibili 3 aperture del fascio per ogni soluzione: 10°- 30°- 54°. È possibile ottenere una vastissima gamma di colori oltre alla possibilità di dimmerazione.

## Wide range of beams and colours

Thanks to the high efficiency lenses, 3 beam angles are available for each version: 10°- 30°- 54°. You can get a wide range of colours and dim the light.

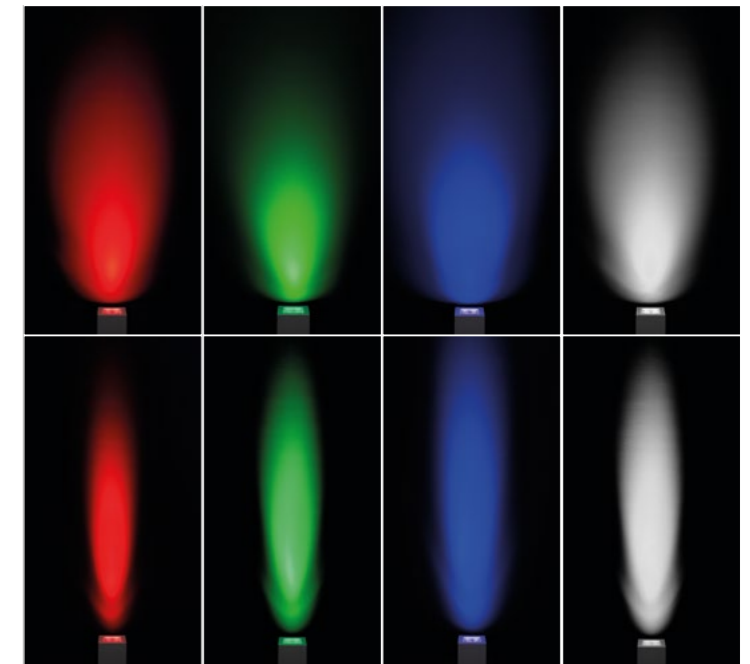
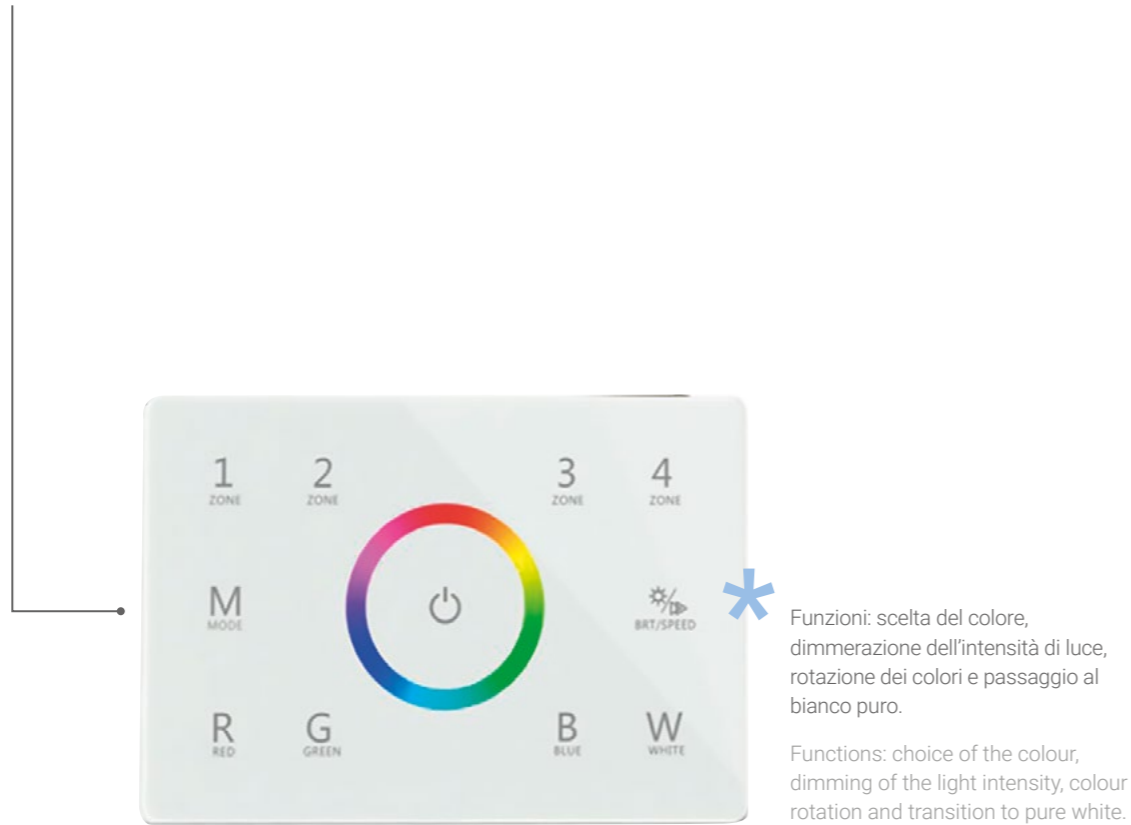

### 230V SISTEMA DI CABLAGGIO / WIRING SYSTEM

Le serie PROTO, K<sup>3</sup> e PASSUM UP Ø 245 presentano soluzioni con alimentatore 230V a bordo controllabili dalla centralina.

The ranges PROTO, K<sup>3</sup> and PASSUM UP Ø 245 come with 230V built-in driver versions controlled by the unit.

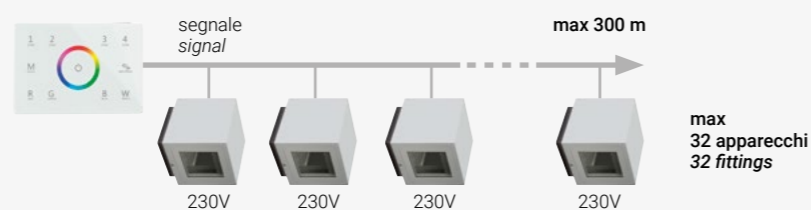

### 24V SISTEMA DI CABLAGGIO / WIRING SYSTEM

Le serie CLOCK, PASSUM UP Ø 125 e PASSUM UP Ø 180 presentano soluzioni a 24V, controllabili in remoto da appositi reattori 24V e dalla centralina.

The ranges CLOCK, PASSUM UP Ø 125 and PASSUM UP Ø 180 come with 24V versions controlled by the unit. Dedicated 24V remote drivers available.

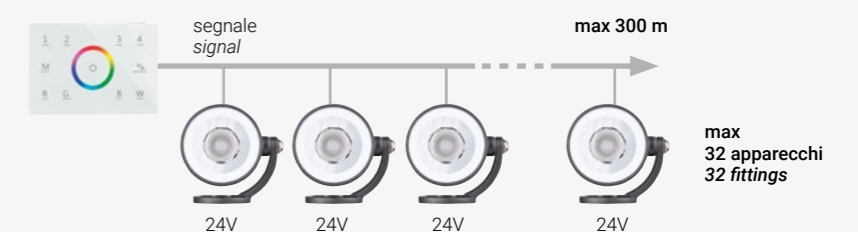



# RGBW CLOCK

Spot / Spotlight



## RGBW CLOCK Ø 80 mm

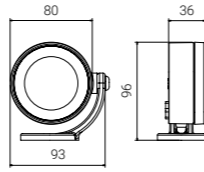

Code	
1186	<ul style="list-style-type: none"> <li><span style="display: inline-block; width: 10px; height: 10px; background-color: black; border-radius: 50%; margin-right: 5px;"></span> AN - anthracite</li> <li><span style="display: inline-block; width: 10px; height: 10px; background-color: grey; border-radius: 50%; margin-right: 5px;"></span> AG - aluminium grey</li> <li><span style="display: inline-block; width: 10px; height: 10px; background-color: green; border-radius: 50%; margin-right: 5px;"></span> VE - green</li> </ul>

Lamp	W	Lm LED	Real Lm	Optic
LED RGBW	12 max	330 max	230 max	30°

Ottiche opzionali / Optional optics 10° (code + 10), 54° (code + 54)

Contiene 1 LED RGBW e dispositivo per ricevere il segnale DMX standard 512 inviato da centralina cod. 1181 o altra centralina compatibile / It contains 1 RGBW LED and a device to receive DMX standard 512 signal sent from the control unit code 1181 or another compatible unit

Fornito con 0,5 m di cavo: segnale + alimentazione a 24V / Supplied with 0,5 m cable: signal + 24V

Driver esterno non compreso / Remote driver to be ordered separately (page 307)

Accessori opzionali: vedi capitolo CLOCK / Optional accessories: see chapter CLOCK (pages 100-108)

**Su richiesta / On request**

Settaggio multicanale degli apparecchi / Multi-channel setting of the fittings

BI - white  CO - corten  BR - bronze

## RGBW CLOCK Ø 120 mm

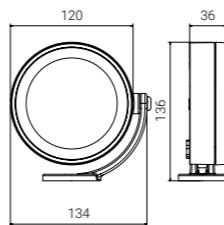

Code	
1187	<ul style="list-style-type: none"> <li><span style="display: inline-block; width: 10px; height: 10px; background-color: black; border-radius: 50%; margin-right: 5px;"></span> AN - anthracite</li> <li><span style="display: inline-block; width: 10px; height: 10px; background-color: grey; border-radius: 50%; margin-right: 5px;"></span> AG - aluminium grey</li> <li><span style="display: inline-block; width: 10px; height: 10px; background-color: green; border-radius: 50%; margin-right: 5px;"></span> VE - green</li> </ul>

Lamp	W	Lm LED	Real Lm	Optic
LED RGBW	25 max	990 max	690 max	30°

Ottiche opzionali / Optional optics 10° (code + 10), 54° (code + 54)

Contiene 3 LED RGBW e dispositivo per ricevere il segnale DMX standard 512 inviato da centralina cod. 1181 o altra centralina compatibile / It contains 3 RGBW LEDs and a device to receive DMX standard 512 signal sent from the control unit code 1181 or another compatible unit

Fornito con 0,5 m di cavo: segnale + alimentazione a 24V / Supplied with 0,5 m cable: signal + 24V

Driver esterno non compreso / Remote driver to be ordered separately (page 307)

Accessori opzionali: vedi capitolo CLOCK / Optional accessories: see chapter CLOCK (pages 100-108)

**Su richiesta / On request**

Settaggio multicanale degli apparecchi / Multi-channel setting of the fittings

BI - white  CO - corten  BR - bronze

# RGBW PROTO

Spot / Spotlight



## RGBW PROTO

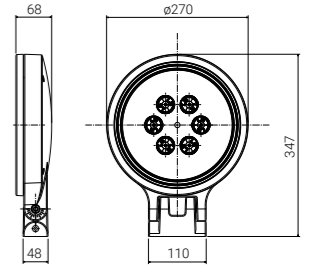

Code	
4939	<ul style="list-style-type: none"> <li><span style="display: inline-block; width: 10px; height: 10px; background-color: black; border-radius: 50%; margin-right: 5px;"></span> AN - anthracite</li> <li><span style="display: inline-block; width: 10px; height: 10px; background-color: grey; border-radius: 50%; margin-right: 5px;"></span> AG - aluminium grey</li> </ul>

Lamp	W	Lm LED	Real Lm	Optic
LED RGBW	17,5	1750	1150	30°

Ottiche opzionali / Optional optics 10° (code + 10), 54° (code + 54)

Contiene 6 LED RGBW e dispositivo per ricevere il segnale DMX standard 512 inviato da centralina cod. 1181 o altra centralina compatibile / It contains 6 RGBW LEDs and a device to receive DMX standard 512 signal sent from the control unit code 1181 or another compatible unit

**Su richiesta / On request**

Settaggio multicanale degli apparecchi / Multi-channel setting of the fittings

# RGBW K<sup>3</sup>

Effetti a parete / Wall effects



## RGBW K<sup>3</sup>

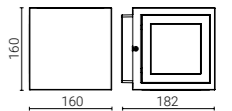

Code	
1184	<ul style="list-style-type: none"> <li><span style="display: inline-block; width: 10px; height: 10px; background-color: black; border-radius: 50%; margin-right: 5px;"></span> AN - anthracite</li> <li><span style="display: inline-block; width: 10px; height: 10px; background-color: grey; border-radius: 50%; margin-right: 5px;"></span> AG - aluminium grey</li> </ul>
1185	<ul style="list-style-type: none"> <li><input type="radio"/> BI - white</li> </ul>

Lamp	W	Lm LED	Real Lm	Optic
LED RGBW	1x32 max	990 max	690 max	1x30°
	2x32 max	1980 max	1380 max	2x30°

Ottiche opzionali / Optional optics 10° (code + 10), 54° (code + 54)

Contiene 3 LED RGBW ogni faccia e dispositivo per ricevere il segnale DMX standard 512 inviato da centralina cod. 1181 o altra centralina compatibile / It contains 3 RGBW LEDs each window and a device to receive DMX standard 512 signal sent from the control unit code 1181 or another compatible unit

**Su richiesta / On request**

Settaggio multicanale degli apparecchi / Multi-channel setting of the fittings

# RGBW PASSUM UP

Incasso a terra o parete / Ground or wall recessed



## CORPO LAMPADA / LIGHT BODY Ø 125 mm

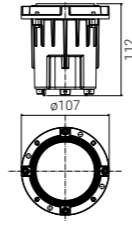

Code	Material	Lamp	W	Lm LED	Real Lm	Optic
1462	aluminium	LED RGBW	12 max	330 max	230 max	30°

Ottiche opzionali / Optional optics 10° (code + 10), 54° (code + 54)

Ottiche basculanti / Adjustable optics ±15°

Contiene 1 LED RGBW e dispositivo per ricevere il segnale DMX standard 512 inviato da centralina cod. 1181 o altra centralina compatibile / It contains 1 RGBW LED and a device to receive DMX standard 512 signal sent from the control unit code 1181 or another compatible unit

Fornito con 0,5 m di cavo: segnale + alimentazione a 24V / Supplied with 0,5 m cable: signal + 24V

Driver esterno non compreso / Remote driver to be ordered separately (page 307)

IP 67 con flange / IP 67 with flanges

Flangia di chiusura e cassaforma non comprese / Covering flange and in-ground box not included (pages 28-29)

[Su richiesta / On request](#)

Settaggio multicanale degli apparecchi / Multi-channel setting of the fittings

## CORPO LAMPADA / LIGHT BODY Ø 180 mm

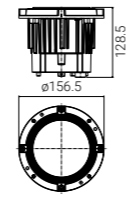

Code	Material	Lamp	W	Lm LED	Real Lm	Optic
1464	aluminium	LED RGBW	25 max	990 max	690 max	30°

Ottiche opzionali / Optional optics 10° (code + 10), 54° (code + 54)

Ottiche basculanti / Adjustable optics ±15°

Contiene 3 LED RGBW e dispositivo per ricevere il segnale DMX standard 512 inviato da centralina cod. 1181 o altra centralina compatibile / It contains 3 RGBW LEDs and a device to receive DMX standard 512 signal sent from the control unit code 1181 or another compatible unit

Fornito con 0,5 m di cavo: segnale + alimentazione a 24V / Supplied with 0,5 m cable: signal + 24V

Driver esterno non compreso / Remote driver to be ordered separately (page 307)

IP 67 con flange / IP 67 with flanges

Flangia di chiusura e cassaforma non comprese / Covering flange and in-ground box not included (pages 30-31)

[Su richiesta / On request](#)

Settaggio multicanale degli apparecchi / Multi-channel setting of the fittings

# RGBW PASSUM UP

Incasso a terra / Ground recessed



## CORPO LAMPADA / LIGHT BODY Ø 245 mm

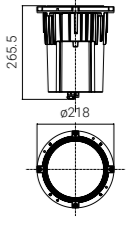

Code	Material	Lamp	W	Lm LED	Real Lm	Optic
1482	aluminium	LED RGBW	32 max	990 max	690 max	30°

Ottiche opzionali / Optional optics 10° (code + 10), 54° (code + 54)

Ottiche basculanti / Adjustable optics ±25°

Contiene 3 LED RGBW e dispositivo per ricevere il segnale DMX standard 512 inviato da centralina cod. 1181 o altra centralina compatibile / It contains 3 RGBW LEDs and a device to receive DMX standard 512 signal sent from the control unit code 1181 or another compatible unit

Fornito con 2 cavi da 0,5 m: segnale + alimentazione a 230V / Supplied with two 0,5 m cables: signal + 230V

IP 67 con flange / IP 67 with flanges

Flangia di chiusura e cassaforma non comprese / Covering flange and in-ground box not included (page 33)

[Su richiesta / On request](#)

Settaggio multicanale degli apparecchi / Multi-channel setting of the fittings





# RGBW

Accessori / Accessories

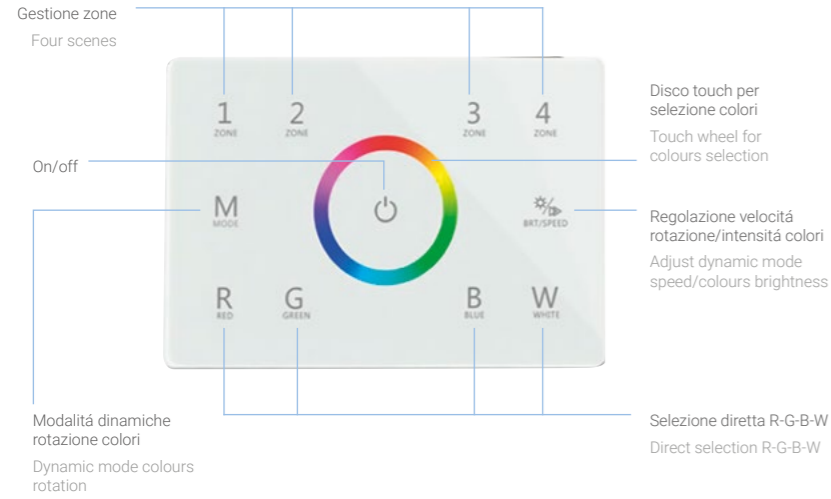

Generatore di segnale DMX 512 Standard con comandi touch screen per pilotare il sistema RGBW degli apparecchi Goccia Illuminazione. Emissione segnale fino alla distanza max di 300 m per un max di n° 32 apparecchi collegati con appropriato cavo per DMX. Per distanze superiori il segnale va amplificato con adeguato ripetitore/ amplificatore di segnale DMX Standard 512.

Touch screen DMX 512 standard signal generator capable to drive the fittings to the system RGBW. Max. of 32 fittings until 300 m with the appropriate DMX cable. For longer distances or signal missing use a relevant signal amplifier.

# RGBW

Accessori / Accessories



## ALIMENTATORI 24V DC / 24V DC CONTROL GEARS

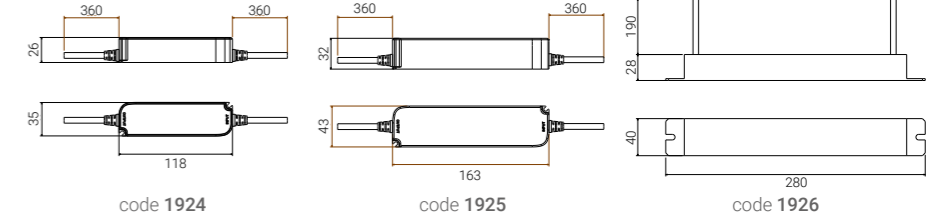

Code	W	Description
1924	24	INPUT 220-240 V - OUTPUT 24V DC
1925	60	
1926	150	

## RGBW CENTRALINA / RGBW SIGNAL GENERATOR

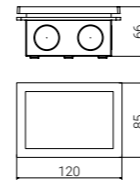

Code	Description
1181	Centralina 230V compatibile con gli apparecchi RGBW, completa di scatola per incasso a muro / Signal generator 230V suitable for RGBW fittings, complete with its backbox to recess in the wall

### Su richiesta / On request

Telecomando e apposito convertitore compatibili con gli apparecchi RGBW / Remote controller and related converter compatible with RGBW fittings  
 Settaggio multicanale degli apparecchi / Multi-channel setting of the fittings

## RAGGRUPPAMENTO SUGGERITO PER SINGOLO ALIMENTATORE REMOTO / SUGGESTED GROUPAGE FOR SINGLE REMOTE CONTROL GEAR

Luminaire			24V remote control gears					
			1924 (24W)		1925 (60W)		1926 (150W)	
Series	Code	W	min	max	min	max	min	max
CLOCK Ø 80 mm	1186	12W	1	2	3	5	7	12
CLOCK Ø 120 mm	1187	25W	-	-	1	2	3	6
PASSUM UP Ø 125 mm	1462	12W	1	2	3	5	7	12
PASSUM UP Ø 180 mm	1464	25W	-	-	1	2	3	6

# ACCESSORI

ACCESSORIES

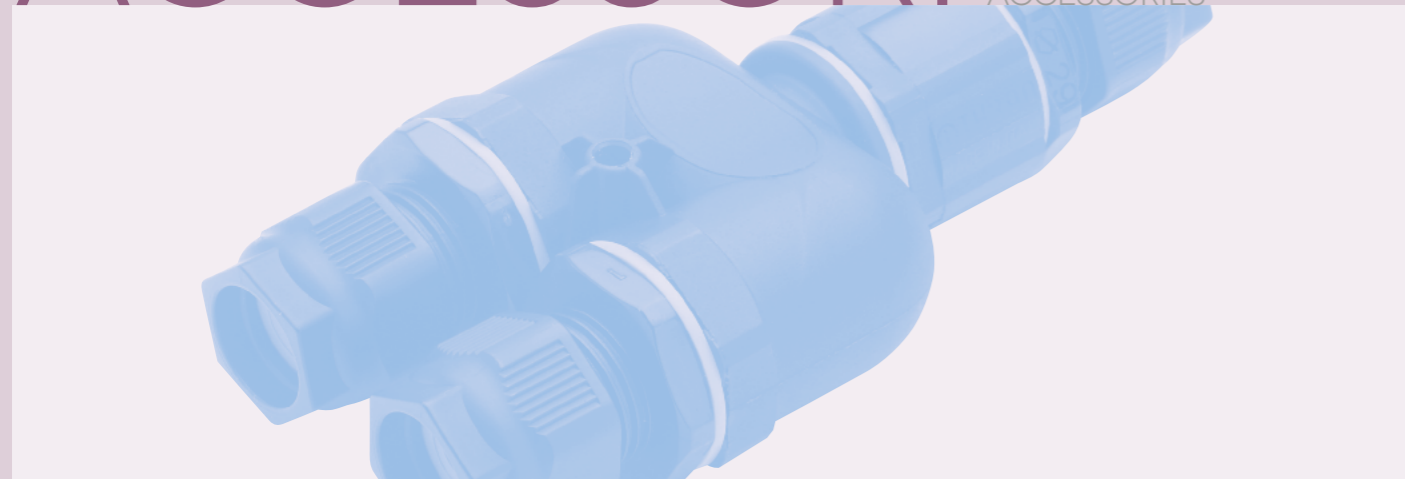

## GIUNTI STAGNI / WATERPROOF CONNECTIONS

IP 68 UK CR CE



code 1941



code 1942

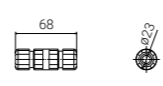

code 1941

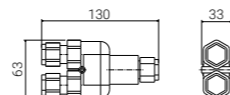

code 1942



code 1943



code 1944

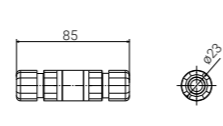

code 1943

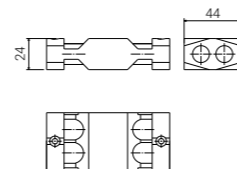

code 1944

Code	Description
1941	Connessione singola 3x2,5 mm <sup>2</sup> IP68 / Single connector 3x2,5 mm <sup>2</sup> IP 68
1942	Connessione entra-esci 3x2,5 mm <sup>2</sup> IP68 / Through wiring connector 3x2,5 mm <sup>2</sup> IP 68
1943	Connessione singola presa-spina 3x2,5 mm <sup>2</sup> IP68 / Plug/socket connector 3x2,5 mm <sup>2</sup> IP 68
1944	Connessione fino a 4 uscite 3x2,5 mm <sup>2</sup> IP68 (basato su gel silconico bicomponente) / Up to 4 outputs connector 3x2,5 mm <sup>2</sup> IP 68, based on two-component silicone gel

## ACCESSORI ACCESSORIES

### ALIMENTATORI 24V DC / 24V DC CONTROL GEARS

24V DC IP 67 UK CR CE

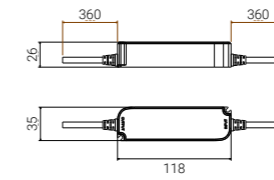

code 1924

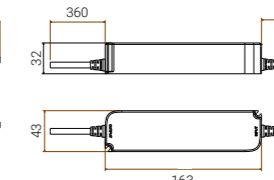

code 1925

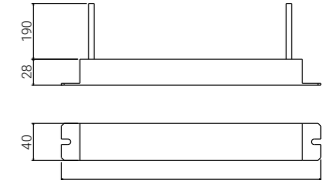

code 1926

Code	W	Description
1924	24	INPUT 220-240 V - OUTPUT 24V DC
1925	60	
1926	150	

### DRIVER DALI

IP 20 UK CR CE

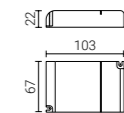

code 1956

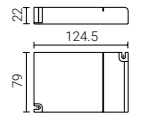

code 1957

Code	Description
1956	INPUT 220-240 V o 110-127 V / AC o DC - OUTPUT 350 mA (17W) / 700 mA (32W)
1957	INPUT 220-240 V o 110-127 V / AC o DC - OUTPUT 350 mA (39W) / 700 mA (60W)

### PROTETTORI DI SOVRATENSIONI / SURGE PROTECTION DEVICES (SPD)

UK CR CE



code 1965



code 1966

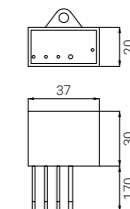

code 1965

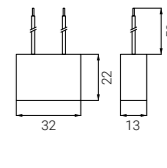

code 1966

Code	Description
1965	SPD type 2+3 Class I 10kV IP67
1966	SPD type 3 Class II 10kV

Da installare ad una distanza max 10 m per proteggere da disturbi di rete /  
To be installed at max 10 m distance to protect against overvoltage



# INFORMAZIONI GENERALI

GENERAL INFORMATION

## CONFORMITÀ COMPLIANCES

CE

Questa marcatura è obbligatoria per la libera circolazione del prodotto nella Comunità Europea e costituisce a tutti gli effetti la dichiarazione da parte del fabbricante che il prodotto è conforme alle direttive (2014/35/UE - 2014/30/UE) e quindi costruito, verificato e collaudato in conformità alle norme (sicurezza e compatibilità EMC) applicabili. La Marcatura CE non comporta controllo o garanzia alcuna da parte di istituti di certificazione volontaria (Marchi di Qualità) / This mark is compulsory for the free trade of the products within the EEC. It represents in every respect the declaration of the manufacturer that the product is in accordance with the directives (2014/35/EU - 2014/30/EU) and therefore manufactured, checked and tested in compliance with the relevant rules (Safety and EMC Compatibility). The CE mark does not require any control or warranty by any voluntary certification institute (Quality Trade Mark)

UK  
CA

La marcatura UKCA (UK Conformity Assessed) è il nuovo marchio di prodotto del Regno Unito che deve essere utilizzato per i prodotti immessi sul mercato in Gran Bretagna (Inghilterra, Galles e Scozia) a dimostrazione della conformità degli stessi alle normative tecniche in vigore in UK: UK SI 2016 No. 1101, UK SI 2016 No. 1091, UK SI 2010 No. 2617, UK SI 2012 No. 3032 / The UK Conformity Assessed (UKCA) mark is a mandatory mark used for products being placed on the market in Great Britain (England, Scotland and Wales) to indicate that they comply with the UK Standards: UK SI 2016 No. 1101, UK SI 2016 No. 1091, UK SI 2010 No. 2617, UK SI 2012 No. 3032.

Gli apparecchi di Goccia Illuminazione sono costruiti e testati secondo le Norme di seguito elencate, in dipendenza della loro tipologia / Goccia Illuminazione luminaires are built and tested according to the Standards listed below, depending on their typology

EN 60598-1	Norma generale - Prescrizioni generali e prove / General requirements and tests
EN 60598-2-13	Prescrizioni particolari - Apparecchi di illuminazione da incasso a terra / Particular requirements - Ground recessed luminaires
EN 60598-2-2	Prescrizioni particolari - Apparecchi di illuminazione da incasso / Particular requirements - Recessed luminaires
EN 60598-2-22	Prescrizioni particolari - Apparecchi di emergenza / Particular requirements - Luminaires for emergency lighting
EN 60598-2-1	Prescrizioni particolari - Apparecchi fissi per uso generale / Particular requirements - Fixed general purpose luminaires

## RESISTENZA AGLI URTI IMPACT RESISTANCE

IK 08

Apparecchio protetto contro un'energia d'impatto di 5 Joule / Luminaire protected against an impact energy of 5 Joules

IK 10

Apparecchio protetto contro un'energia d'impatto di 20 Joule / Luminaire protected against an impact energy of 20 Joules

## CLASSI DI ISOLAMENTO INSULATION CLASSES



Apparecchio dotato di isolamento di base. Protezione: collegamento delle parti metalliche accessibili alla terra di protezione. L'apparecchio richiede la messa a terra / Luminaire with basic insulation. Protection: connection of the accessible metal parts to the earthing protection. Earthing required



Apparecchio dotato di doppio isolamento. Protezione: mediante isolamento supplementare / Luminaire with double insulation. Protection: through additional insulation



Apparecchio idoneo per alimentazione a bassissima tensione di sicurezza. Protezione: intrinsecamente sicuro. Le parti che portano corrente possono essere accessibili / Luminaire suitable for supply at safety extra low voltage. Protection: intrinsically safe. The live parts can be accessed

## CLASSIFICAZIONE IP

### IP RATING

**IP 44**

Apparecchio protetto contro la penetrazione di corpi solidi  $\varnothing > 1$  mm e dagli spruzzi d'acqua /  
Luminaire protected against solid  $\varnothing > 1$  mm and splashing water

**IP 55**

Apparecchio protetto contro la penetrazione della polvere e da getti d'acqua /  
Luminaire protected against powder and water jets

**IP 65**

Apparecchio a tenuta di polvere e protetto da getti di acqua /  
Dust-tight luminaire and protected against water jets

**IP 66**

Apparecchio a tenuta di polvere e protetto da ondate /  
Dust-tight luminaire and protected against powerful water jets

**IP 67**

Apparecchio a tenuta di polvere e protetto da immersione temporanea /  
Dust-tight luminaire and protected against temporary immersion

## ICONE

### ICONS

**24V DC**

24V DC

**230V  
50Hz**

230V 50 Hz

**CRI 80**

Indice resa cromatica / Color rendering index

**2.000 kg**

Carrabile, carico massimo: 2.000, 3.500 kg / Drive over, maximum load: 2.000, 3.500 kg

**500 kg**

Calpestabile, carico massimo: 500, 1.000, 2.000 kg / Walk over, maximum load: 500, 1.000, 2.000 kg

**T ≤ 40°C**

Temperatura di contatto sul diffusore  $T \leq 40^\circ\text{C}$  / Contact temperature on diffuser  $T \leq 40^\circ\text{C}$

**Funzione Corridor**

Funzione Corridor / Corridor function

**100%**

20% BLACK OUT  
Illuminazione d'emergenza / Emergency lighting

## ICONE

### ICONS



Diffusore antivandalo / Vandalproof diffuser



Incasso a terra, calpestabile di superficie con ottica fissa /  
Ground recessed, ground surface mounted with fixed optic



Incasso a terra con ottiche basculanti / Ground recessed with adjustable optics



Incasso a parete, lampada segnalibro, spot o a parete con ottica fissa /  
Wall recessed, steplight, spotlight or wall mounted with fixed optic



Incasso a parete con ottiche basculanti / Wall recessed with adjustable optics



Incasso a soffitto, downlight o spot con ottica fissa /  
Ceiling recessed, downlight or spotlight with fixed optic



Incasso a soffitto con ottiche basculanti / Ceiling recessed with adjustable optics



Palo, stelo, torretta multifunzione o arredo urbano /  
Post, stem, garden power point or urban lighting



Effetti a parete / Wall effects



Apparecchio orientabile / Adjustable fitting



Apparecchio RGBW / RGBW fitting



## INDICE PER CODICE

### INDEX BY CODE

Code	Series	Page
1004	K³ WRITER	220
1008	K³ WRITER	220
1022	K³ WRITER	220
1040	K³ MINILED	216
1041	K³ MINILED	216
1042	K³ MINILED	216
1043	K³ MINILED	216
1044	K³ MINILED	216
1045	K³ MINILED	216
1046	K³ MINILED	216
1087	LUX SHOWER	259
1090	K³ MINILED	217
1091	K³ WRITER	221
1092	K³ WRITER	221
1093	K³ WRITER	221
1095	K³ WRITER	221
1096	K³ WRITER	221
1102	K³ POWER	224
1105	K³ POWER	224
1106	K³ POWER	224
1109	K³ POWER	224
1122	K³ POWER	224
1123	K³ POWER	224
1128	K³ POWER	224
1141	K³ POWER	224
1142	K³ POWER	224
1146	K³ POWER	224
1147	K³ POWER	224
1181	RGBW	306
1184	RGBW	303
1185	RGBW	303
1186	RGBW	302
1187	RGBW	302
1191	K³ POWER	225
1192	K³ POWER	225
1193	K³ POWER	225

Code	Series	Page
1194	K³ POWER	225
1203	CORINTHIA	252
1204	CORINTHIA	252
1208	CORINTHIA	252
1213	CORINTHIA	252
1221	LUX SHOWER	258
1222	LUX SHOWER	258
1225	LUX SHOWER	259
1226	LUX SHOWER	259
1231	CORINTHIA	252
1232	CORINTHIA	252
1241	KYKLO	265
1242	KYKLO	265
1301	WASH	208
1302	WASH	208
1305	WASH	208
1306	WASH	208
1308	WASH	208
1309	WASH	208
1311	WASH	210
1312	WASH	210
1321	WASH	209
1322	WASH	209
1324	WASH	209
1325	WASH	209
1327	WASH	209
1328	WASH	209
1332	WASH	210
1333	WASH	210
1401	PASSUM	27
1411	PASSUM	26/36
1412	PASSUM	26
1413	PASSUM	26
1415	PASSUM	36
1416	PASSUM	36
1421	PASSUM	28/38

Code	Series	Page
1422	PASSUM	28
1423	PASSUM	27
1424	PASSUM	28
1427	PASSUM	38
1431	PASSUM	30/39/42
1432	PASSUM	30
1433	PASSUM	30
1434	PASSUM	30
1436	PASSUM	39
1438	PASSUM	42
1440	PASSUM	33
1441	PASSUM	33
1442	PASSUM	33
1444	PASSUM	33
1451	SQUEEZE	58
1453	SQUEEZE	56
1454	SQUEEZE	56
1455	SQUEEZE	56
1457	SQUEEZE	56
1458	SQUEEZE	56
1459	SQUEEZE	56
1462	RGBW	304
1464	RGBW	304
1467	SQUEEZE	57
1468	SQUEEZE	57
1469	SQUEEZE	57
1470	PASSUM	46
1471	PASSUM	48
1472	PASSUM	46
1473	PASSUM	46
1474	PASSUM	47
1475	PASSUM	47
1476	PASSUM	48
1478	PASSUM	48
1479	PASSUM	47
1481	PASSUM	36

Code	Series	Page
1482	RGBW	305
1484	PASSUM	36
1485	PASSUM	38
1487	PASSUM	39
1488	PASSUM	42
1491	PASSUM	26
1494	PASSUM	26
1495	PASSUM	28
1496	PASSUM	28
1497	PASSUM	30
1498	PASSUM	30
1511	PASSUM	26
1512	PASSUM	26
1513	PASSUM	26
1515	PASSUM	37
1516	PASSUM	37
1517	PASSUM	37
1519	PASSUM	37
1521	PASSUM	27/29
1522	PASSUM	27/29
1523	PASSUM	27/29
1525	PASSUM	38
1526	PASSUM	38
1527	PASSUM	38
1529	PASSUM	38
1531	PASSUM	31
1532	PASSUM	31
1533	PASSUM	31
1535	PASSUM	39
1536	PASSUM	39
1537	PASSUM	39
1539	PASSUM	39
1541	PASSUM	33
1542	PASSUM	33
1591	PASSUM	37
1593	PASSUM	37

## INDICE PER CODICE INDEX BY CODE

Code	Series	Page
1594	PASSUM	37
1924	ACCESSORI / ACCESSORIES	50/59/76/307/309
1925	ACCESSORI / ACCESSORIES	50/59/76/307/309
1926	ACCESSORI / ACCESSORIES	307/309
1941	ACCESSORI / ACCESSORIES	51/71/100/133/308
1942	ACCESSORI / ACCESSORIES	51/100/133/308
1943	ACCESSORI / ACCESSORIES	253/308
1944	ACCESSORI / ACCESSORIES	51/71/100/308
1956	ACCESSORI / ACCESSORIES	309
1957	ACCESSORI / ACCESSORIES	309
1965	ACCESSORI / ACCESSORIES	309
1966	ACCESSORI / ACCESSORIES	309
1971	PASSUM	51
1972	PASSUM	51
2143	JACK	291
2191	JACK	290
2213	JACK	290
2214	JACK	290
2215	JACK	290
2216	JACK	290
2217	JACK	290
2241	JACK	291
2263	JACK	291
2264	JACK	291
2265	JACK	291
2267	JACK	291
2291	JACK	290
2806	MARINA	297
2895	MARINA	297
3101	T-LUX	162
3102	T-LUX	162
3103	T-LUX	162
3341	TRIANGOLO	241
3344	TRIANGOLO	241
3401	IANUS	141
3402	IANUS	141

Code	Series	Page
3421	CANTHARELLUS / I-MAGO / I-LUX / I-DEA	173/187/196/203
3422	CANTHARELLUS / I-MAGO / I-LUX / I-DEA	173/187/196/203
3423	CANTHARELLUS	173
3504	PROTO / CANTHUS	118/180
3505	PROTO / CANTHUS	118/180
3511	I-MAGO / I-LUX	187/196
3512	I-MAGO / I-LUX	187/196
3601	T-LUX	157
3602	T-LUX	157
3603	T-LUX	157
4170	TRIANGOLO	240
4220	TRIANGOLO	240
4223	TRIANGOLO	240
4225	TRIANGOLO	241
4229	TRIANGOLO	240
4230	TRIANGOLO	240
4450	SMALL MIDI MAXI & SUPERMAXI	231
4455	SMALL MIDI MAXI & SUPERMAXI	231
4510	MARINA	296
4560	MARINA	296
4590	MARINA	296
4592	MARINA	296
4661	CLOCK	99
4664	CLOCK	99
4665	CLOCK	99
4668	CLOCK	100
4669	CLOCK	100
4681	CLOCK	105
4682	CLOCK	105
4683	CLOCK	105
4691	CLOCK	101
4692	CLOCK	101
4693	CLOCK	107
4694	CLOCK	107
4695	CLOCK	105/107

Code	Series	Page
4696	CLOCK / T-LUX	108/162
4697	CLOCK / T-LUX	108/163
4698	CLOCK / T-LUX	108/163
4699	CLOCK	107
4720	MARINA	297
4780	MARINA	297
4790	MARINA	297
4792	MARINA	297
4935	PROTO	114
4936	PROTO	114
4937	PROTO	114
4938	PROTO	114
4939	RGBW	303
5061	PROTO	118
5062	PROTO	118
5066	VOLTO	247
5080	SMALL MIDI MAXI & SUPERMAXI	234
5081	VOLTO	247
5091	SMALL MIDI MAXI & SUPERMAXI	234
5212	SMALL MIDI MAXI & SUPERMAXI	231
5213	SMALL MIDI MAXI & SUPERMAXI	231
5221	SMALL MIDI MAXI & SUPERMAXI	231
5223	SMALL MIDI MAXI & SUPERMAXI	231
5232	SMALL MIDI MAXI & SUPERMAXI	231
5233	SMALL MIDI MAXI & SUPERMAXI	231
5301	SERVER POINT	124
5302	SERVER POINT	124
5303	SERVER POINT	124
5308	SERVER POINT	125
5309	SERVER POINT	125
5315	SERVER POINT	125
5321	STAMP	64
5323	STAMP	64
5326	STAMP	64
5331	STAMP	74
5335	STAMP	80

Code	Series	Page
5336	STAMP	80
5337	STAMP	80
5351	STAMP	66/76/81
5352	STAMP	66
5357	STAMP	66
5358	STAMP	66/77
5359	STAMP	66
5360	STAMP	67/77/81
5371	STAMP	68
5372	STAMP	68
5374	STAMP	75
5375	STAMP	75
5381	STAMP	68
5382	STAMP	68
5383	STAMP	68
5384	STAMP	68
5391	STAMP	71/75
5392	STAMP	71
5420	QUANTUM	87
5425	QUANTUM	86
5430	QUANTUM	88
5435	QUANTUM	89
5440	QUANTUM	90
5441	QUANTUM	86
5442	QUANTUM	87
5443	QUANTUM	88
5444	QUANTUM	89
5452	QUANTUM	86
5453	QUANTUM	88
5454	QUANTUM	89
5455	QUANTUM	90
5460	QUANTUM	87
5462	QUANTUM	86
5463	QUANTUM	88
5464	QUANTUM	89
5465	QUANTUM	90



**INDICE PER CODICE**  
INDEX BY CODE

Code	Series	Page
5466	QUANTUM	90
5467	QUANTUM	90
5472	QUANTUM	86
5473	QUANTUM	88
5474	QUANTUM	89
5475	QUANTUM	90
5476	QUANTUM	90
5477	QUANTUM	90
5480	QUANTUM	91
5481	QUANTUM	91
5482	QUANTUM	91
5500	I-MAGO	187
5502	I-LUX	194
5504	I-LUX	194
5505	I-MAGO / I-LUX / I-DEA	188/197/203
5506	IANUS / CANTHARELLUS / I-MAGO / I-LUX	141/173/188/197
5510	I-MAGO	187
5512	I-LUX	196
5513	I-LUX	196
5514	I-LUX	196
5516	I-LUX	196
5517	I-LUX	194
5518	IANUS	141
5519	CANTHARELLUS / I-MAGO / I-LUX / I-DEA	173/188/197/203
5521	CANTHARELLUS	172
5522	CANTHARELLUS	172
5523	CANTHUS	180
5524	CANTHUS	180
5526	STANDING	132
5527	IANUS	149
5528	STANDING	133
5529	QUANTUM / STANDING	92/133
5531	I-DEA	202
5534	I-DEA	202
5536	I-DEA	202

Code	Series	Page
5537	I-DEA	202
5538	CLOCK / IANUS / T-LUX	108/144/157
5540	I-LUX	194
5551	T-LUX	160
5552	T-LUX	160
5553	T-LUX	156
5555	T-LUX	157
5558	T-LUX	166
5559	T-LUX	166
5593	QUANTUM	92
5594	QUANTUM	92
5606	SMALL MIDI MAXI & SUPERMAXI	230
5607	SMALL MIDI MAXI & SUPERMAXI	230
5608	SMALL MIDI MAXI & SUPERMAXI	230
5609	SMALL MIDI MAXI & SUPERMAXI	230
5621	SMALL MIDI MAXI & SUPERMAXI	230
5622	SMALL MIDI MAXI & SUPERMAXI	230
5635	SMALL MIDI MAXI & SUPERMAXI	231
5638	SMALL MIDI MAXI & SUPERMAXI	231
5692	SMALL MIDI MAXI & SUPERMAXI	233
5693	SMALL MIDI MAXI & SUPERMAXI	233
5694	SMALL MIDI MAXI & SUPERMAXI	233
5696	SMALL MIDI MAXI & SUPERMAXI	233
5700	SMALL MIDI MAXI & SUPERMAXI	232
5704	SMALL MIDI MAXI & SUPERMAXI	232
5705	SMALL MIDI MAXI & SUPERMAXI	233
5708	SMALL MIDI MAXI & SUPERMAXI	233
5863	VOLTO	246
5864	VOLTO	247
7071	IANUS	140
7072	IANUS	140
7073	IANUS	144
7074	IANUS	144
7075	IANUS	144
7076	IANUS	144
7081	IANUS	148

Code	Series	Page
7082	IANUS	148
7083	IANUS	149
7084	IANUS	149
8110	KASKO	285
8190	KASKO	285
8310	KASKO	283
8320	KASKO	283
8390	KASKO	283
8395	KASKO	283
8410	KASKO	282
8420	KASKO	282
8490	KASKO	282
8495	KASKO	282
8610	KASKO	284
8620	KASKO	284
8690	KASKO	284
8695	KASKO	284
8810	KASKO	285
8890	KASKO	285
9060	DOCKS	276
9064	DOCKS	276
9067	DOCKS	277
9070	DOCKS	276
9074	DOCKS	276
9077	DOCKS	277
9104	DOCKS	276
9108	DOCKS	276
9121	DOCKS	276
9127	DOCKS	277
9133	DOCKS	276
9138	DOCKS	277
9150	KASKO	282
9154	KASKO	282
9160	KASKO	283
9164	KASKO	283
9170	KASKO	284

Code	Series	Page
9174	KASKO	284
9182	KASKO	285
9184	KASKO	285
9186	KASKO	285
9187	KASKO	285
9201	LUNETTE	270
9202	LUNETTE	270
9206	LUNETTE	270
9207	LUNETTE	270
9211	LUNETTE	271
9212	LUNETTE	271



Concept & Production: Vittoria Comunica

**goccia**  
ILLUMINAZIONE

Consultate sul sito [www.goccia.it](http://www.goccia.it) l'elenco aggiornato degli agenti /  
See the complete list of agents and distributors on [www.goccia.it](http://www.goccia.it)





Tel. 070-644 28 16 - [info@nordicecoenergy.se](mailto:info@nordicecoenergy.se) - [www.nordicecoenergy.se](http://www.nordicecoenergy.se)

**Goccia Illuminazione srl**

Via E. Fermi, 59/65  
25020 Poncarale (BS) Italy  
T. +39 030 26 40 761  
F. +39 030 26 40 271

Svensk återförsäljare:  
[info@nordicecoenergy.se](mailto:info@nordicecoenergy.se)

