

I-MAGO



Con il suo disegno unico e sapiente nelle proporzioni I-MAGO esalta la leggerezza e lo slancio delle forme accendendosi come una piccola cascata, una clessidra luminosa. L'esile stelo che si illumina in realtà supporta una scheda LED superiore capace di illuminare cospicuamente a terra in modo diretto, verso il basso, con un'apertura di diffusione di 120° e senza dispersione verso l'alto. Per inserirsi con discrezione ed eleganza nei giardini, presso i camminamenti, ai bordi degli spazi aperti, si compone con i pali in due diverse altezze in alluminio estruso o acciaio inossidabile.

With its unique design and skilful proportions, I-MAGO enhances the lightness and momentum of the shapes, lighting up like a small waterfall, a luminous hourglass. The slender stem that actually lights up supports an upper LED board capable of brightly illuminating the ground directly, downwards, with a diffusion angle of 120° and without upward dispersion. To fit with discretion and elegance in the gardens, near the walkways, at the edges of open spaces, it is composed with poles in two different heights in extruded aluminum or stainless steel.

POLES



I-MAGO

I-MAGO



Struttura

Coppa in policarbonato trasparente stabilizzato anti UV. Parti interne in alluminio satinato. Corpo completo di scatola di cablaggio in tecnopolimero autoestinguente con anello di raccordo in alluminio verniciato o cromato.

Structure

Transparent polycarbonate UV resistant stabilised diffuser. Internal parts in satin aluminium. Body complete with self-extinguishing technopolymer wiring box with painted aluminium or chrome connection ring.

Il corpo lampada è dotato di 2 bocchettoni PG9 per consentire l'alimentazione passante.

The lamp body is provided with 2 inlets PG9 for through wiring.

Pali

- in **alluminio** estruso, a forma di poliedro stonato a 16 lati, completi di base in alluminio forgiato. Disponibili in due differenti altezze. La finitura grafite anti-UV garantisce la completa tenuta nel tempo
- in **acciaio inox AISI 316L**, spazzolati e lucidati, destinati a resistere nel tempo anche negli ambienti maggiormente esposti a corrosione. La sezione poligonale è un personale design di GOCCIA ottenuto da trafilatura

Poles

- in **extruded aluminium** with 16 rounded sides profile and base in forged aluminium. Available in two different heights. The finish graphite makes I-LUX not invasive and ideal to be installed everywhere in the garden
- in **AISI 316L stainless steel**, brushed and polished, made to resist to the most corrosive environments. The original polygonal profile enhances the pole

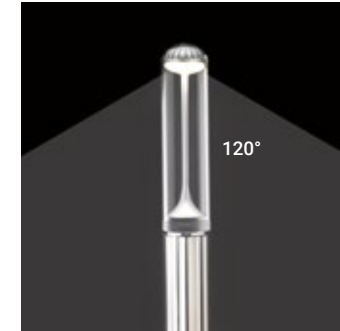
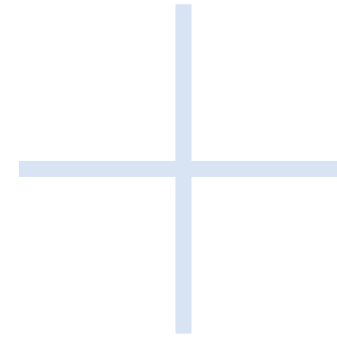

Piccola cascata di luce

La luce dei 4 LED di potenza è orientata verso il basso con un angolo di diffusione di 120°.

Small waterfall of light

The light from the 4 power LEDs is directed downwards with an angle of diffusion of 120°.

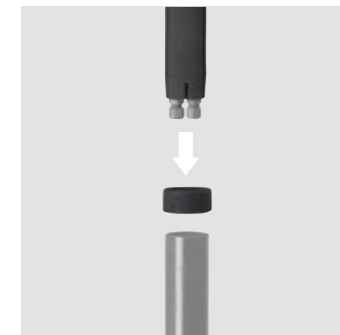

Adattatore per pali Ø 60 mm

Gli apparecchi I-MAGO possono essere installati mediante uno speciale raccordo anche su qualsiasi palo di mercato di Ø 60 mm.

Adaptor for Ø 60 mm poles

I-MAGO can be installed on any type of Ø 60 mm pole available on the market by a very simple adaptor.



I-MAGO

Pali da giardino / Garden poles



CORPI LAMPADA / LIGHT BODIES



aluminium



AISI 316L st. steel

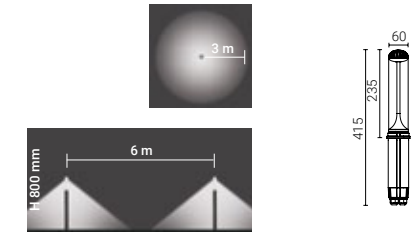

		Code	
5510		GR - graphite	3K - 3000 K
5500		IN - stainless steel	4K - 4000 K

Material	Lamp	W	Lm LED	Real Lm	Beam
aluminium	LED	7,5	750	380	diffuse
AISI 316L st. steel					

Su richiesta / On Request

10÷52V low voltage (code + LV)

PALI / POLES





codes 3501 3502 GR



codes 3511 3512 IN



		Code
3501		GR - graphite
3511		IN - stainless steel

H	Description
375 mm	Palo in alluminio estruso e base in alluminio forgiato / Pole in extruded aluminium and base in forged aluminium
800 mm	
375 mm	Palo e base in acciaio inox AISI 316L, interamente spazzolato e lucidato / Pole and base in AISI 316L stainless steel, brushed and polished
800 mm	

I-MAGO

Accessori / Accessories

CE

PICCHETTO / SPIKE

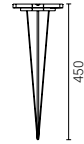

Code	Description
5505	Picchetto da giardino in tecnopolimero, listelli laterali di bloccaggio incorporati / Garden spike in technopolymer, side blocking bars incorporated

PIASTRA TIRAFONDI / PLATE WITH ANCHORING SET

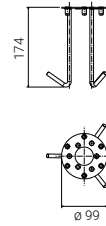

Code	Description
5519	Piastra inox con tirafondi per ancoraggio al terreno / Stainless steel plate with ground anchoring set

RACCORDO PER PALI STANDARD / ADAPTOR FOR STANDARD POLES Ø 60 mm

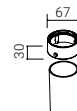

Code	Description
5506	Raccordo in alluminio primario pressofuso, adattabile a qualsiasi palo Ø 60 mm / Adaptor in die-cast primary aluminium, to be installed on any pole Ø 60 mm



PALI Ø 60 - 76 mm

Sistema completo per pali / Complete system for poles

Products	CANTHARELLUS	CANTHUS	I-MAGO	I-LUX	I-DEA
Lampshades					
Light bodies					
Arms					
Poles	<p>H 375 H 800</p> <p>H 1875</p>	<p>H 3000</p>		<p>H 375 H 800 H 375 H 800</p>	<p>H 375 H 800</p>
Plates with anchoring set Spike					