

DOWNLIGHT

DOWNLIGHT

LUX SHOWER



Le soluzioni per l'illuminazione downlight di LUX SHOWER si articolano in tre diverse dimensioni per l'installazione sulla superficie di partizioni orizzontali e coperture, con numerose varianti di apertura dei fasci luminosi. Le tre dimensioni e le diverse portate illuminanti trovano una cifra estetica e di stile adatta al tipo ed all'altezza di installazione, offrendo tutte una solida struttura in alluminio e vetro temperato per garantire una tenuta IP 65.

The LUX SHOWER downlight solutions are divided into three different sizes for installation on the surface of horizontal partitions and roofs, with numerous variations of the light beam angles. Three dimensions and the different illuminating ranges find an aesthetic and style reason suited to the type and height of installation, all offering a solid structure in aluminum and tempered glass to guarantee an IP 65 rating.

CEILING



LUX SHOWER
30



LUX SHOWER
100

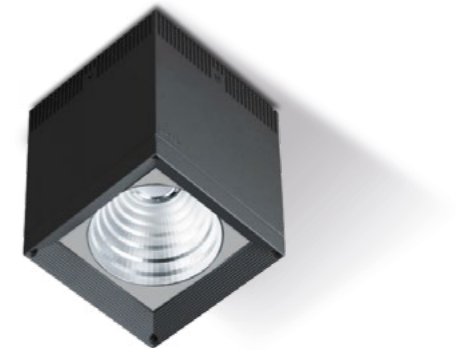

LUX SHOWER
200

LUX SHOWER

Struttura

Diffusore in vetro temperato. Corpo lampada, basetta e cornice fermavetro in alluminio primario anticorrosione a basso tenore di rame. Ingresso cavi dal retro.

Structure

Tempered glass diffuser. Light body, base and frame in primary low copper content aluminium alloy, UV and harsh conditions resistant. Rear cable entry.

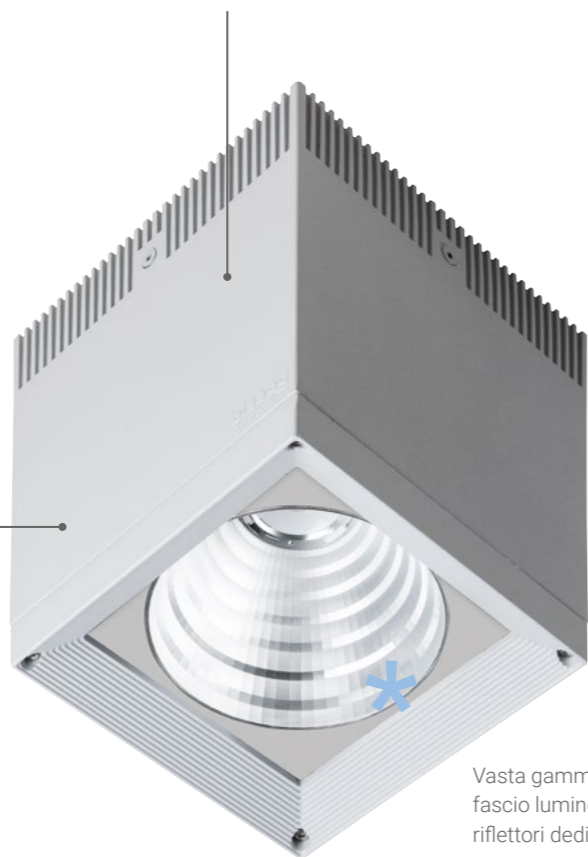

Vasta gamma di aperture del fascio luminoso grazie a lenti e riflettori dedicati.

Wide range of beam angles available thanks to the incorporated optical reflectors

Dimensioni

Disponibili in 3 dimensioni con 36-102-200 mm di altezza.

Dimensions

Available in three dimensions with 36-102-200 mm height.

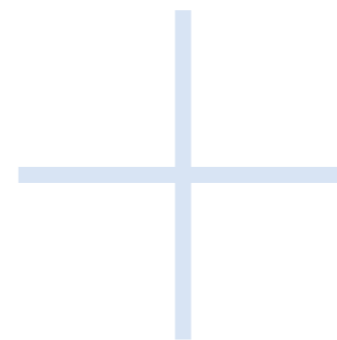

Minimo spessore

Apparecchio di soli 36 mm di spessore con potente ottica LED integrata funzionante a 230V. Tre angoli di diffusione: 12°- 40°- 90° e versione opale.

Minimum thickness

Ceiling fixture with only 36 mm thickness and 230V LED module inside. 3 beam angles: 12°- 40°- 90° and opal version.



Potenza in un minicubo

L'apparecchio di soli 100 mm di lato, grazie al LED 15W con parabola integrata, offre un'elevata resa luminosa. 3 angoli di diffusione: 18°-38°- 90° e vetro opale.

Minimal design and high efficiency

A 100x100 mm minicube with 15W LED and optical reflectors ensures high performances. 3 beam angles: 18°- 38°- 90° and opal glass.

LUX SHOWER

Soffitto / Ceiling



LUX SHOWER 30

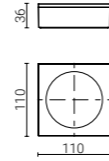

Code	
1221	<ul style="list-style-type: none"> ● AN - anthracite ● AG - aluminium grey
1222	<ul style="list-style-type: none"> ○ BI - white

Ottiche opzionali / Optional optics
1221 12° (code + **12**), 90° (code + **90**)

1222 Versione opale / Opal version

Modulo LED a tensione di rete, compatibile con dimmer a taglio di fase /
Mains voltage LED module, compatible with most phase-cut dimmers

Ingresso cavi laterale mediante distanziale cod. 5351 / Side cable entry by the
accessory code 5351 (page 81)

Lamp	W	Lm LED	Real Lm	Optic
LED	10	1100	750	40°
			363	diffuse

Su richiesta / On request

24V low voltage (code + **24V**)

LUX SHOWER

Soffitto / Ceiling



LUX SHOWER 100

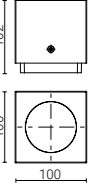

Code	
1225	<ul style="list-style-type: none"> ● AN - anthracite ● AG - aluminium grey
1226	<ul style="list-style-type: none"> ○ BI - white

Ottiche opzionali / Optional optics
1225 18° (code + **18**), 90° (code + **90**)

1226 Versione opale / Opal version

Modulo LED a tensione di rete, compatibile con dimmer a taglio di fase /
Mains voltage LED module, compatible with most phase-cut dimmers

Lamp	W	Lm LED	Real Lm	Optic
LED	15	1575	950	38°
			419	diffuse

Su richiesta / On request

12-24V low voltage

LUX SHOWER 200

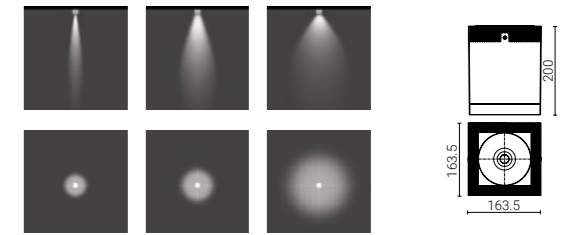
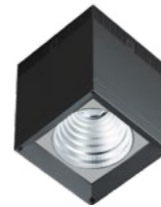

Code	
1087	<ul style="list-style-type: none"> ● AN - anthracite ● AG - aluminium grey ○ BI - white

Ottiche opzionali / Optional optics
18° (code + **18**), 70° (code + **70**)

Lamp	W	Lm LED	Real Lm	Optic
LED	23	3329	2434	38°

Su richiesta / On request

Versione dimmerabile / Dimmable version

